

# Blackburn II (2AL-RC) variabel



- |                                  |                                |
|----------------------------------|--------------------------------|
| (DE) Montageanleitung            | (FR) Notice de montage         |
| (PL) Instrukcja montażu          | (RO) Instrucțiuni de asamblare |
| (NL) Handleiding voor de montage | (SK) Montážny návod            |
| (GB) Assembly instructions       | (CZ) Montážní návod            |
| (TR) Montaj talimatı             | (HU) Szerelési útmutató        |
| (RU) Инструкция по монтажу       | (SLO) Navodila za montažo      |
| (IT) Istruzioni di montaggio     |                                |

Service - Servis - Dienstverlening - Servis - Serwis - Сервисная служба - Servizio - Service  
 Serviciu - Služby - Szolgáltatás - Storitev

Da es sich hier um ein variables Modell handelt, muss vor Montage entschieden werden, welches Element rechts oder links stehen soll. Entsprechend müssen dann die Arm- bzw. Rückenlehnen angebracht werden. Hierzu den Reißverschluss an der Unterseite öffnen und anhand der vorhandenen Bohrungen in den Seitenwänden die Löcher im Stoff freilegen (Schiere, Cuttermesser o.ä.).

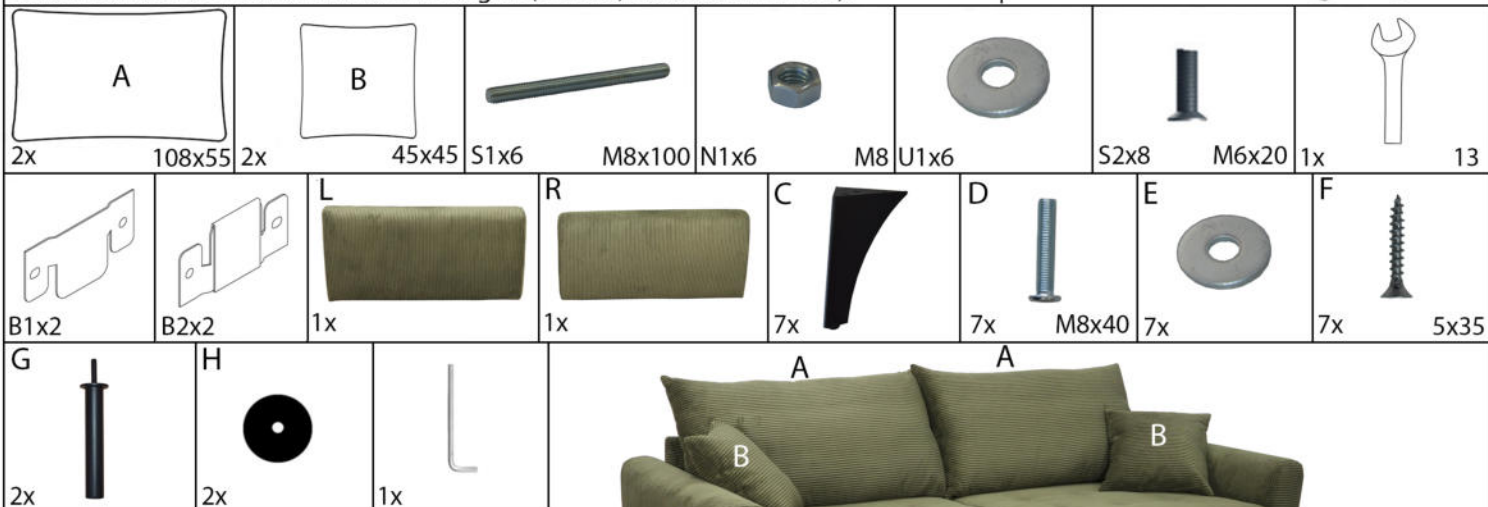
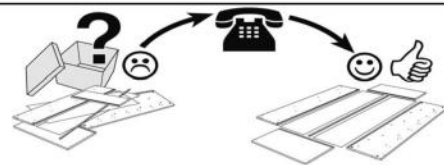

2AL-RC  
L=2-5

RC-2AL  
R=6-8

07-08-2024

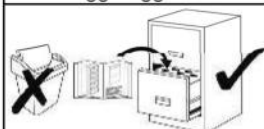
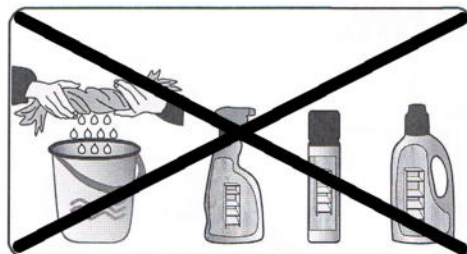
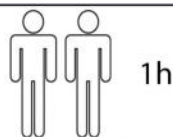







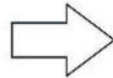
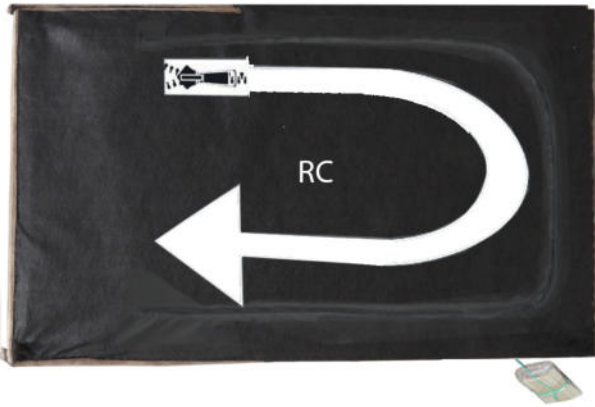
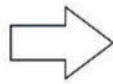

- DE** Da es sich hier um ein variables Modell handelt, muss vor Montage entschieden werden, welches Element rechts oder links stehen soll. Entsprechend müssen dann die Arm- bzw. Rückenlehnen angebracht werden. Hierzu den Reißverschluss an der Unterseite öffnen und anhand der vorhandenen Bohrungen in den Seitenwänden die Löcher im Stoff freilegen (Schere, Cuttermesser o.ä.).
- PL** Ponieważ chodzi tutaj o model variabel, należy zdecydować przed montażem, jaki element powinien zostać postawiony, prawy czy lewy.  
W takim razie należy odpowiednio zamontować podłokietniki, ewentualnie oparcia. Proszę otworzyć zamek błyskawiczny na spodniej stronie i na podstawie istniejących otworów na ścianach bocznych proszę wykonać otwory w tkaninie (nożyczki, nóż).
- NL** Omdat hier om een variabel model gaat moet voor de montage de beslissing genomen zijn welke element zou geplaatst moeten zijn, rechter of linker. Er dienen dus op de juiste wijze de armleuningen gemonteerd te zijn, eventueel de ondersteuning. Open de ritssluiting aan de onderkant en op basis van de bestaande openingen op de zijwanden doe de openingen in de stof (schaar, mes).
- GB** As it is concerned with the variable model, it must be decided before the installation which element shall be put up, right or left.  
In that case, install accordingly armrest or backrest.  
Please, unzip the fastener of the underside of the material and make holes in the fabric in accordance with the existing holes in the side panels (use: scissors, knife).
- TR** Bu model variabel olduğundan montaja başlamadan önce parçanın hangısı, sağ or sol parça kaldırılacağına karar veriniz.  
Kol dayanakları ve arkalık da ona göre monte ediniz. Arka taraftaki fermuar açınız ve yan taraflarda bulunan deliklere göre kumaşta delik yapınız (makas, bıçakla).
- RU** Поскольку это модель Variabel, перед монтажом необходимо решить, какой элемент следует разместить, правый или левый.  
В этом случае следует правильно установить подлокотники, эвентуально спинки. Откройте молнию на изнаночной стороне и используйте существующие отверстия на боковых стенках, чтобы сделать отверстия в ткани (ножницы, нож).
- IT** Trattandosi di un modello variabel, è necessario decidere prima del montaggio quale elemento deve essere posizionato, destro o sinistro. In tal caso, i braccioli o gli schienali devono essere installati correttamente. Si prega di aprire la cerniera sul lato inferiore e utilizzando i fori esistenti sulle pareti laterali fare i fori nel tessuto (forbici, coltello).
- FR** Puisqu'il s'agit d'un modèle variabel, il est nécessaire de décider avant l'assemblage quel élément doit être placé, à droite ou à gauche. Dans ce cas, les accoudoirs ou les dossiers doivent être correctement installés. Veuillez ouvrir la fermeture éclair sur le dessous et utiliser les trous existants sur les parois latérales pour faire des trous dans le tissu (ciseaux, couteau).
- RO** Deoarece în acest caz este vorba de modelul variabel, înainte de asamblare este necesar să decideți ce element trebuie montat, drept sau stâng.  
În acest caz, cotierele – eventual spătarele - trebuie instalate în mod corespunzător. Vă rugăm să deschideți fermoarul din partea inferioară și să folosiți orificiile existente pe pereții laterali pentru a face orificii în țesătură (foarfece, cuțit).
- SK** V tomto prípade ide o model variabel, preto je potrebné sa rozhodnúť ešte pred montážou, ktorý prvok chcete zvýšiť – na ľavej alebo na pravej strane.  
Podľa toho vhodne pripevnite laktové opierky a prípadne operadlá. Otvorte zips na spodnej strane a podľa viditeľných otvorov na bočných stenách urobte aj otvory v potahu (nožnice, nôž).
- CZ** Jde tady o model – typ variabel, musíte před montáží rozhodnout, který s elementů musí zůstat postavený, pravý nebo levý.  
V tomto případě musíte zamontovat příslušné podloketníky, eventuálně opěradla /opření/.  
Otevřte prosím na spodní straně zdrhovadlo a podle skutečných= faktických dírek=otvorů na bočních stěnách, udělejte otvory v tkanině / nůžkama, nožem/
- HU** Mivel itt a variabel modellről van szó, szerelés előtt döntse el, hogy milyen elem legyen felállítható, jobb vagy bal.  
Ebben az esetben megfelelően szerelje a kartámszokat, esetleg a háttámlákat. Húzza le az alsó részén lévő cipzárt és az oldalsó falakon lévő nyílások alapján készítsen nyílásokat a szövetben (olló, kés).





 S1x3	 N1x3	 U1x3	 S2x4	 L	 L 2AL-RC
 1x	<b>2AL</b>		<b>2</b>		

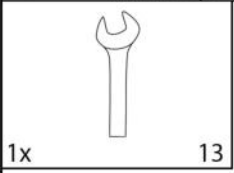

**1**

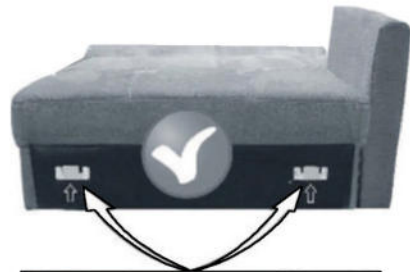
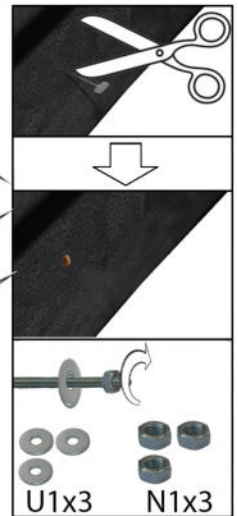
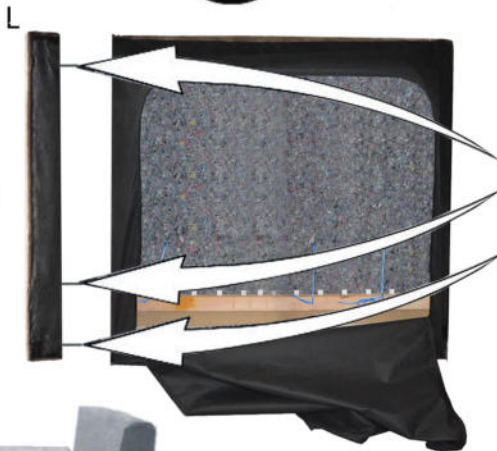
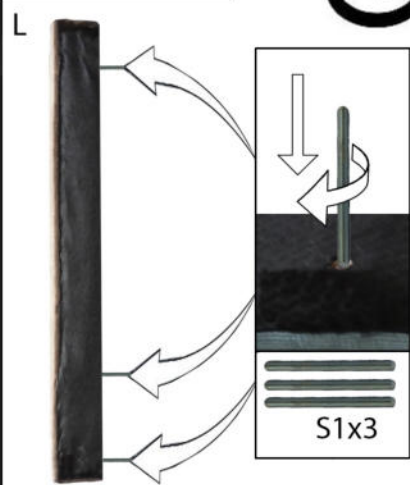

**3**

07-08-2024

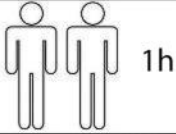
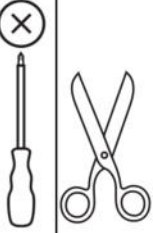
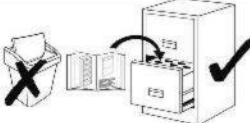
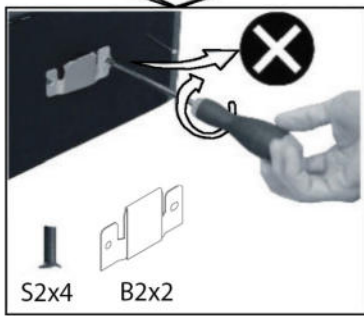



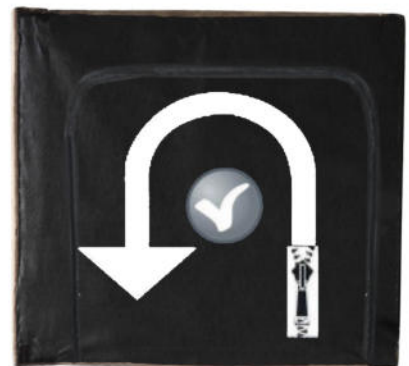

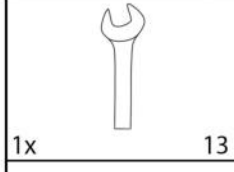
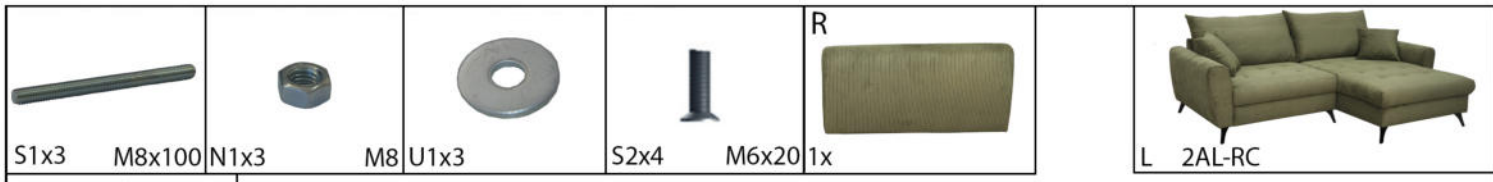
**4**



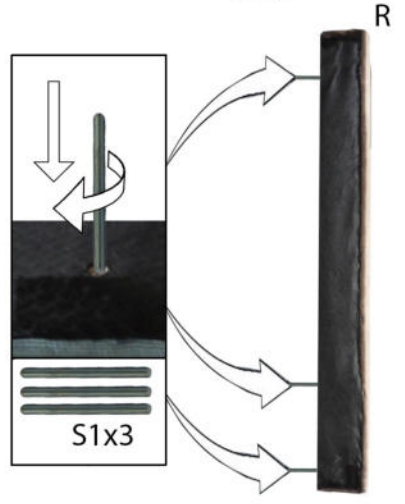

**5**



RC

**6**

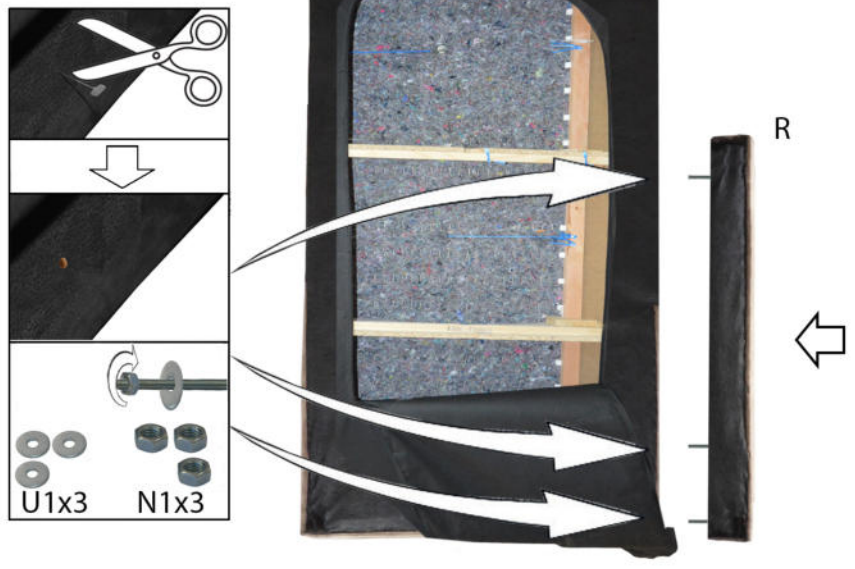

**7**

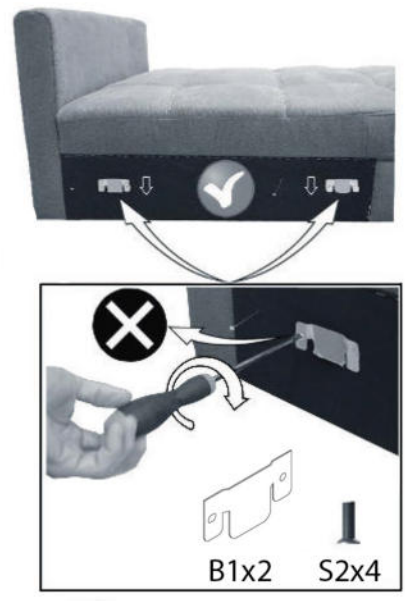

**8**



07-08-2024

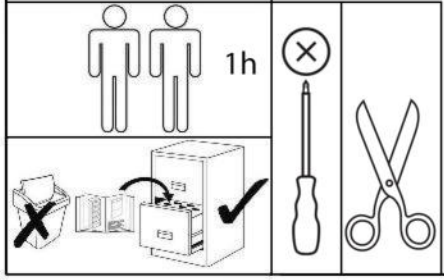

- C 7x
- D 7x M8x40
- E 7x
- F 7x 5x35
- G 2x
- H 2x
- L 2AL-RC

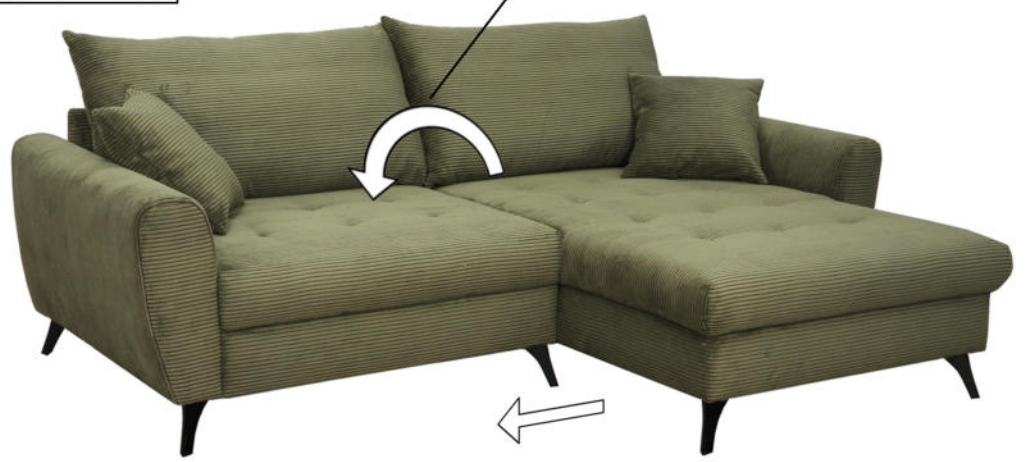
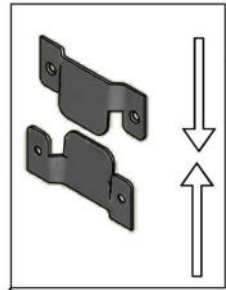
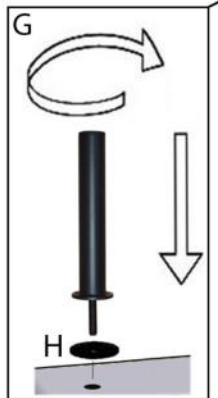
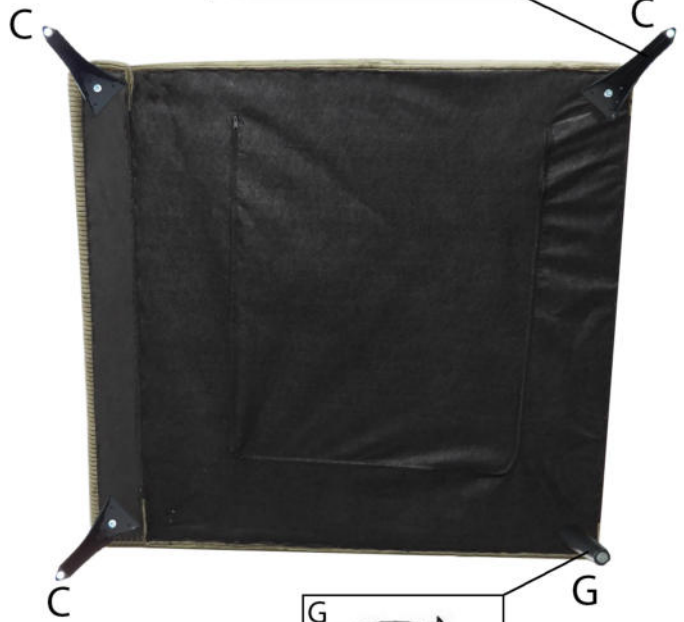
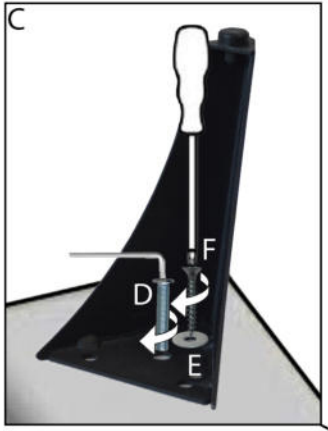
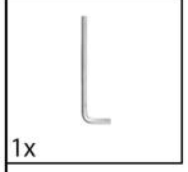

07-08-2024

1h





S1x3



U1x3



N1x3



S2x4

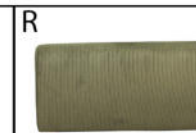

M6x20



1x



R RC-2AL



1x

13

# 2AL

1

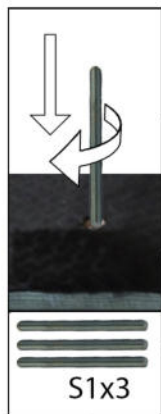

S1x3



R

2

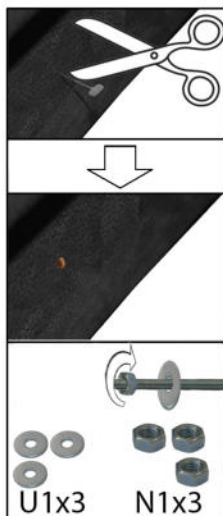

U1x3

N1x3

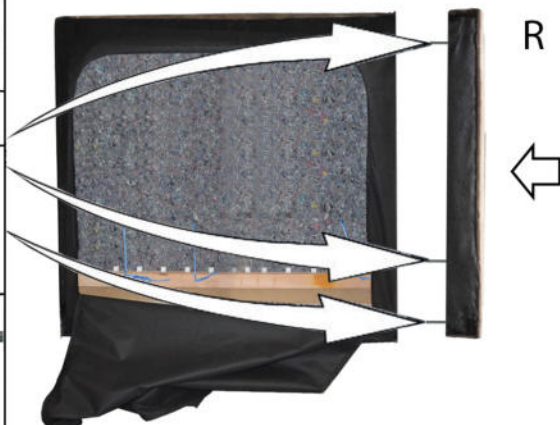

R



3

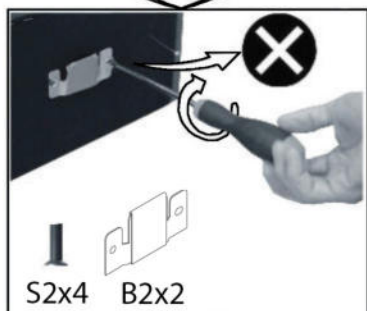

S2x4

B2x2

4

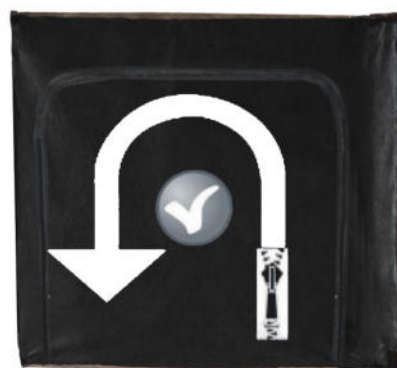

07-08-2024

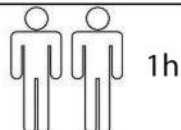

1h

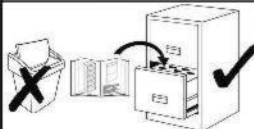
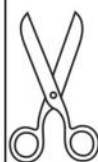

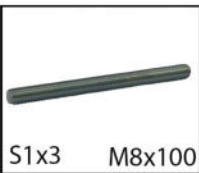

S1x3

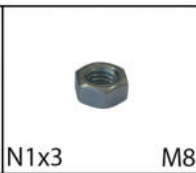

N1x3



M8 U1x3



S2x4

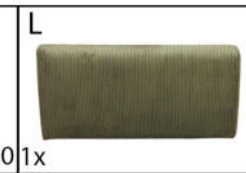

M6x20

L



R RC-2AL

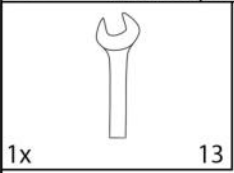

1x

13

5

RC

6

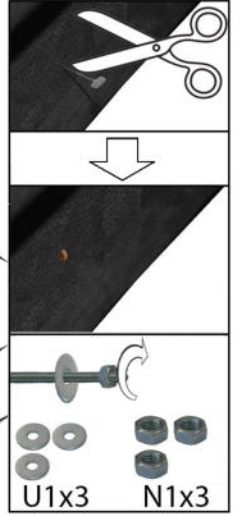
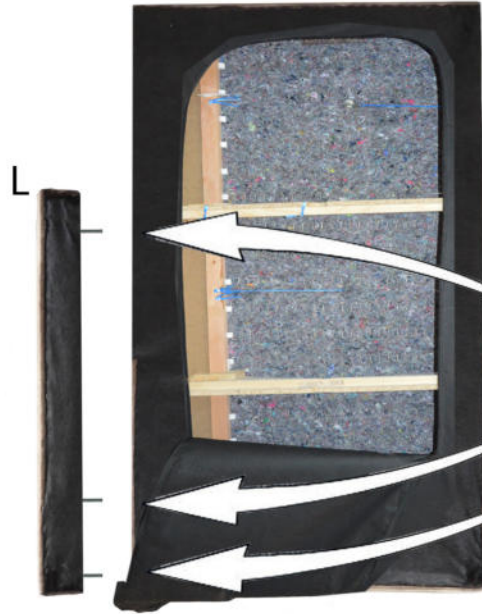
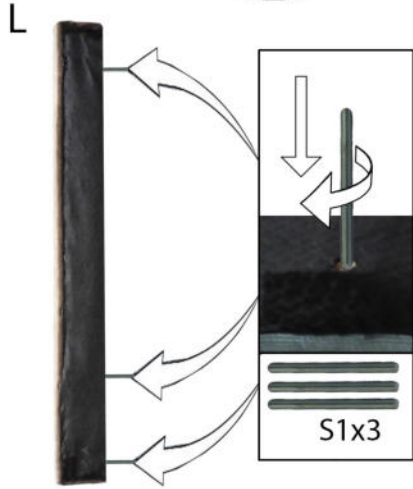

7

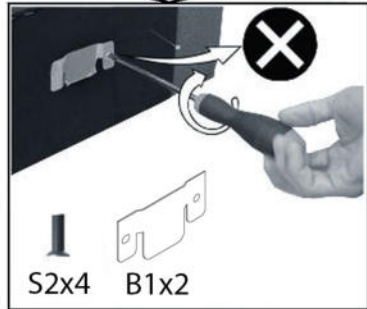

8



07-08-2024

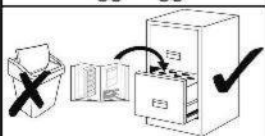
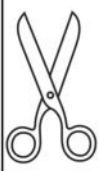
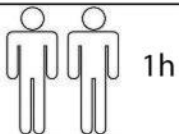

- C 7x
- D 7x M8x40
- E 7x
- F 7x 5x35
- G 2x
- H 2x
- R RC-2AL

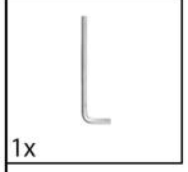

9

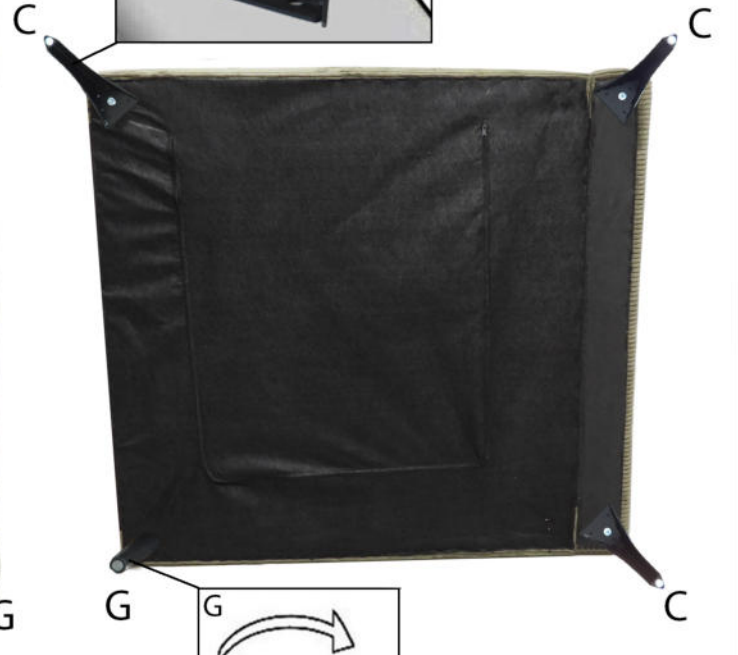
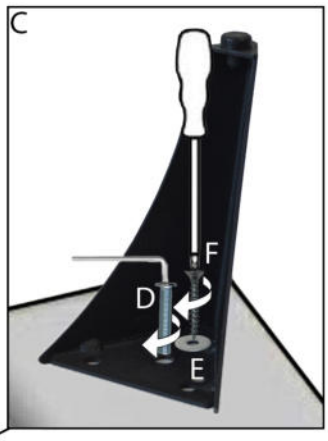

10

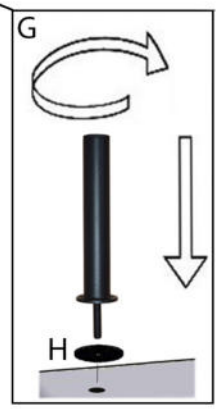
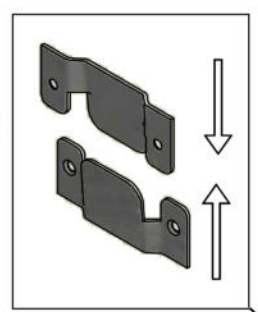

07-08-2024

1h