

PORTABLE CARPET CLEANER

USER'S MANUAL

W05

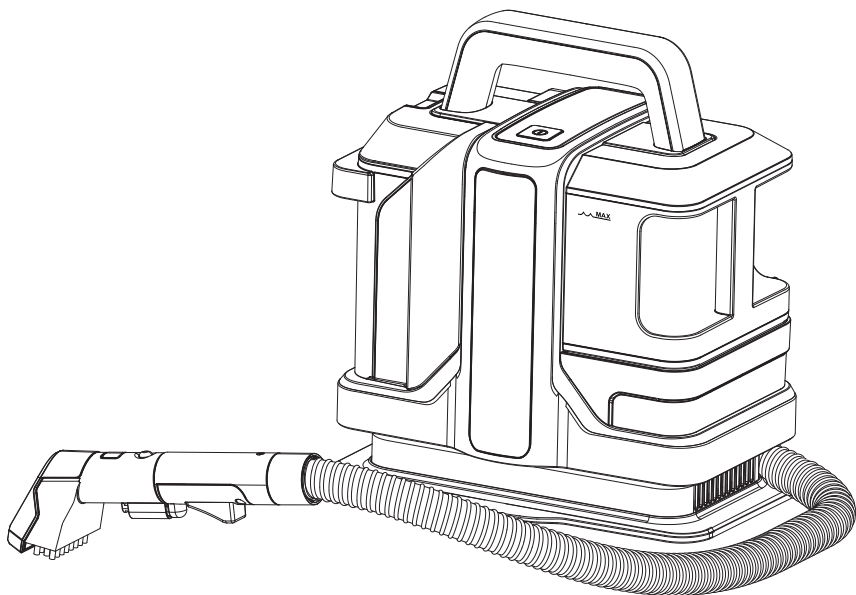

Read the instruction manual before using the machine.
Save it well.

WARNING

Notice before use

- Use water under 40°C in order to remove dirt from the unit .
- Do not use it to clean arts and crafts, fibers and items not suitable for cleaning by water, and surfaces easy to be hurt (like floor, table and so on) .
- Do not slant if with water in the tank to avoid wetting floor.
- Stop the machine and empty the dirty water tank if it reaches the full line.
- Make sure the detergent used is not bad for your washed items.
- The machine may stop when cleaning long hair carpet due to blocked air outlet Stop the machine if big quantity of foam or dirty water comes out and empty the dirty water tank before use it again.
- Do not use foam detergent.
- Please make sure the users need assistant (including children) are under supervision when they use the machine.
- Do not use liquid like pesticides, hair dyes and lubricant .
- Do not use to pick up any flammable or combustible objects or cigarettes.
- Do not use to pick up any oil or hot air, or dry dust .
- Do not use it if the hose is broken, avoid bending, stampede and pulling violently of the hose.
- Do not block the air outlet to avoid influence on the heat dissipation.
- Stop use it in case of any unusual noise and smell.
- Do not disassemble, repair and change the machine's structure by yourself.
- Do not use it under the scene of heavy wind or rain.
- Do not immerse in water or liquid to avoid fire or electric shock hazard.
- Do not use to pick up any dust with infectious danger.
- Do not use without dirty water tank in position.
- If the supply cord is damaged, it must be replaced by the manufacturer, its service agent or similarly qualified persons in order to avoid a hazard.
- This appliance can be used by children aged from 8 years and above and persons with reduced physical, sensory or mental capabilities or lack of experience and knowledge if they have been given supervision or instruction concerning use of the appliance in a safe way and understand the hazards involved. children shall not play with the appliance. Cleaning and user maintenance shall not be made by children without supervision.
- This appliance may be normal used under 50Hz or 60Hz the frequency need not to be adjusted.

Correct Disposal of this product



This marking indicates that this product should not be disposed with other household wastes throughout the EU. To prevent possible harm to the environment or human health from uncontrolled waste disposal, recycle it responsibly to promote the sustainable reuse of material resources. To return your used device, please use the return and collection systems or contact the retailer where the product was purchased. They can take this product for environmental safe recycling.

PRECAUTIONS TO SOME FAILURES

- This machine is mainly for wet using, do not use to pick up large quantity of dust.
- Dry the dirty water tank, clean water tank and inside of the hose if the temperature is extremely low to avoid freezing.
- Take out foreign matters from the hose when blocked before use it again.

USE THE POWER CORD AND PLUG PROPERLY

- Clean the plug from time to time.
- Plug in well when use it.
- Unplug the machine if the machine will not be used for a long time.
- Unplug the machine before maintenance, checking and moving.
- Do not plug or unplug the machine with wet hands.
- Keep the plug away from kids.
- Do not damage the power cord. Do not pull the plug violently when move the machine.
- Do not use the machine in case of damaged power cord or plug.
- Do not use overloaded socket.
- Do not use in case of any failures, cut the power and unplug the machine.

BELOW MATTERS ARE NOT ALLOWED TO BE PICKED UP

- Dry dust
- Big quantity of powder
- Big quantity of sand and stones
- Big quantity of rubbish
- Metal matters like needles, pins
- Big polybag and stockings
- Things easy to be dumped inside

CAUTION

- Do not use it other than cleaning.
- This machine is for household use only.
- Do not close to fire or heating equipment.
- Stop working if the water-spray mouth is blocked.
- Stop working if any foreign matters are taken in.
- Empty the tanks if anything in block before use again.
- Do not slant or ride on the machine.
- Do not use it in the scope touchable for kids.
- Not for outdoor use.
- Do not continue to use when the suction hole is blocked.

KNOW-HOW OF THE MACHINE

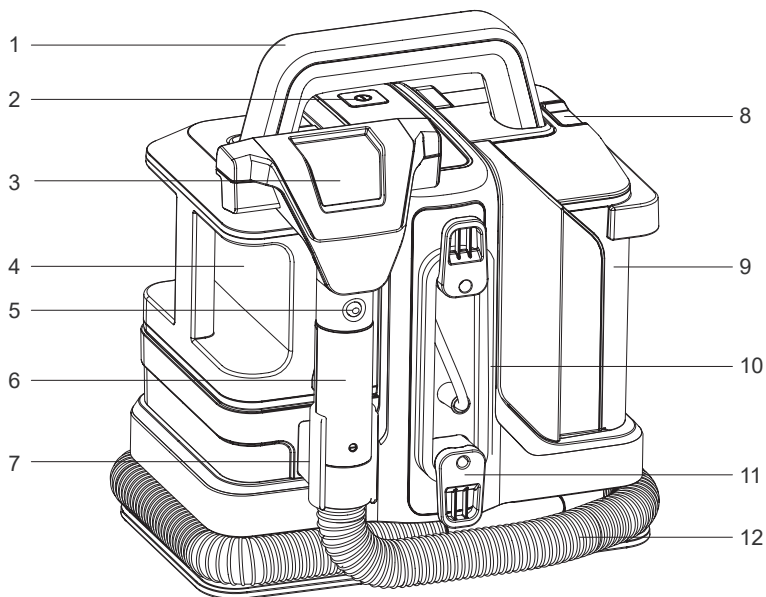

COMPONENTS LIST :

- 1、 Handle
- 2、 Switch
- 3、 Big brush
- 4、 Clean water tank
- 5、 Released button for brush
- 6、 Brush handle
- 7、 Hook for brush
- 8、 Button for dirty water tank
- 9、 Dirty water tank
- 10、 Power cord
- 11、 Power cord hook
- 12、 Hose
- 13、 Small brush



13

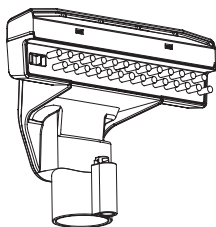

3

PREPARATIONS BEFORE USE

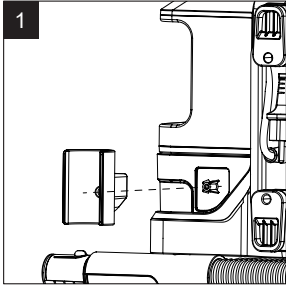

1
Take the hose hook from the handle, insert it into the machine and screw it tightly.

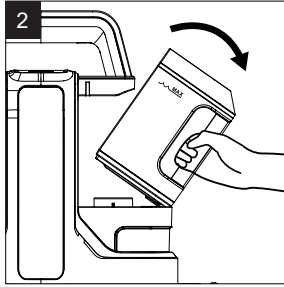

2
Take out the clean water tank.
Notice: pull the clean water tank with an angle of 30 degree to take it out.

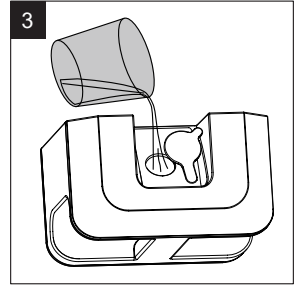

3
Take out the sealing pad, fill the clean tank and seal it by the sealing pad.

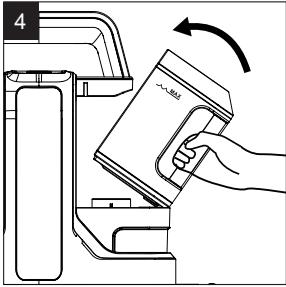

4
Put the clean water tank in.
Notice: lock the bottom part to the machine, then put the clean water tank in.

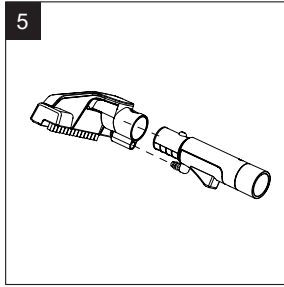

5
Assemble the brush as you may want.

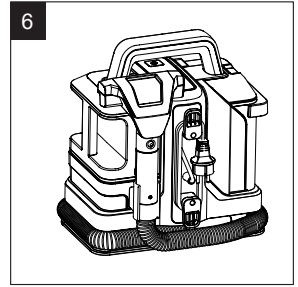

6
Wrap the hose around the base and insert the hook.

HOW TO USE



1 Plug the power cord and press ON/OFF button.

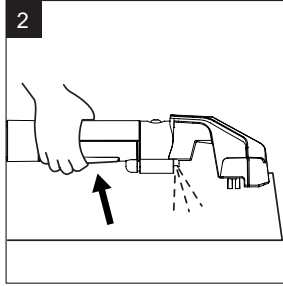

2 Press the water-spray button to spray water.

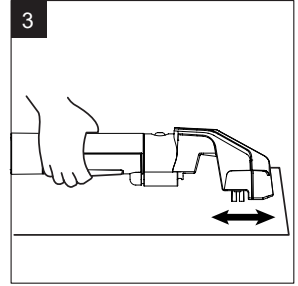

3 Brush the unit back and forth to clean stains.

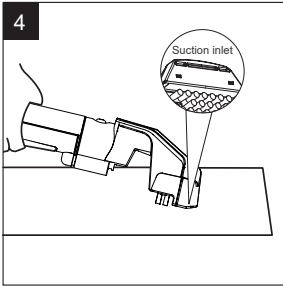

4 Press the brush in the stains position to suck all dirty water.



5 Power it off after cleaning. Wrap the hose around the base and lock in the hook.

Notice: clean the dirty water tank after every use to avoid unpleasant smell

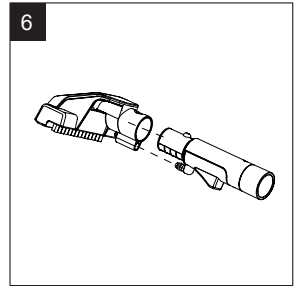

6 Please use big brush when clean big surface cleaning to save time.

HOW TO CLEAN STUBBORN STAINS

Use fabric detergent to clean stubborn stains. Make the water and detergent with a certain proportion to fill the tank to the full line mark, and then install the clean water tank to the machine

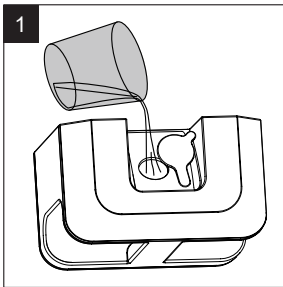

1 Open the water-in sealing pad, fill the clean water tank.

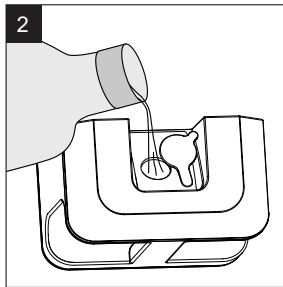

2 Put detergent into the tank.

CLEAN THE CLEAN WATER TANK

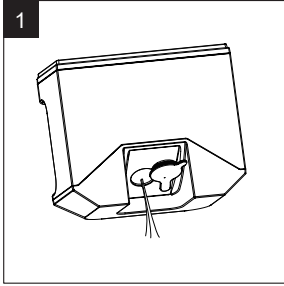

1 Pour water out from the tank.

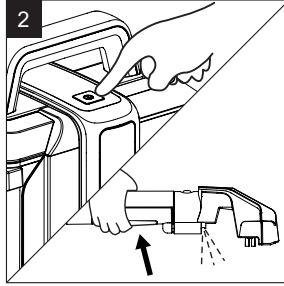

2 Install that empty clean water tank and press the water-spray button to spray the rest water.

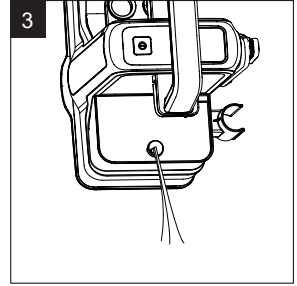

3 Slant the machine after plug off to dump all water.

CLEAN THE DIRTY WATER TANK

Clean the dirty water tank after every use to avoid unpleasant smell.

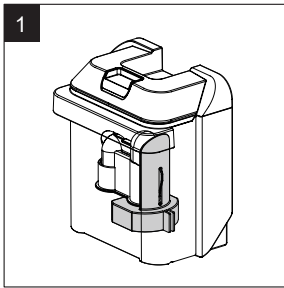

1 Clean the dirty water tank before it reaches to the full line mark. The float inside will work to stop sucking if it is full of dirty water.

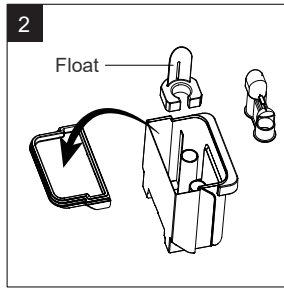

2 Take out the dirty water tank, open the tank cover, take out the wind guide tube and float.

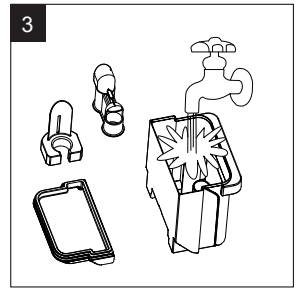

3 Clean all parts.

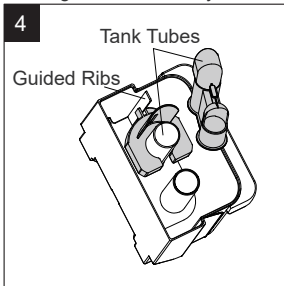

4 Clean the clean water tank Tubes Guided ribs Insert the clean floating along the guided ribs, then insert the high part of wind guided tube into the high part of the tube inside the tank, and tighten the tank cover.

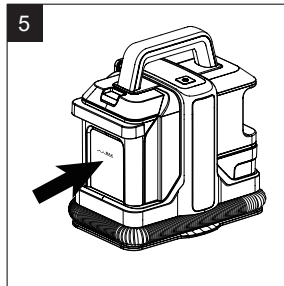

5 Install the dirty water tank to the machine.

QUESTIONS

Please read below table carefully before contacting the maintenance agency to avoid any unnecessary losses.

Fault	Possible Reasons	Messures
No working after turning on	<ul style="list-style-type: none"> ● The plug is not well plugged ● The cord is damaged 	Turn if off, plug in well, or consult the service agent via hotline
No water comes out or little water comes out after pressing the water-spray button	<ul style="list-style-type: none"> ● Spray water mouth is blocked ● The handle or the pump has been damaged 	Take out the brush, wash the spray water mouth or consult the service agent via hotline.
No suction or weak suction power	<ul style="list-style-type: none"> ● The machine is not on ● The dirty water tank is full ● The hose is not in good status ● The wind-in sponge is blocked 	Turn on the power. Clean the dirty water tank to use it again. Check the hose to make sure it is in well status. Clean or change the sponge.

SPECIFICATIONS

Name	portable carpet cleaner
Item number	W05
Voltage/Frequency	220-240V~ 50/60Hz
Rated power	450W
Max vacuity	≥11 kPa
Capacity of clean water tank/ Dirty water tank	1080ML / 800ML
IP rating	IPX4