

WORX®

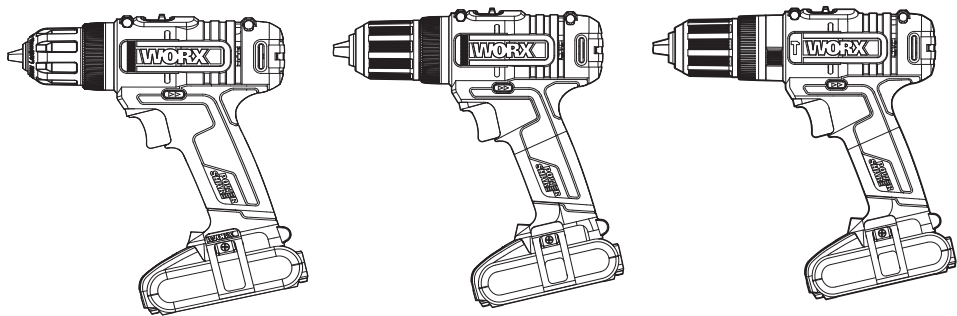

SAFETY AND OPERATING MANUAL

D-LITE

**WX100 WX100.X WX108 WX108.X
WX370 WX370.X**



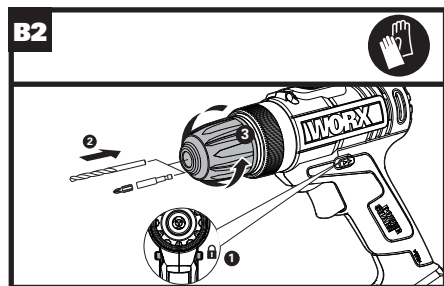
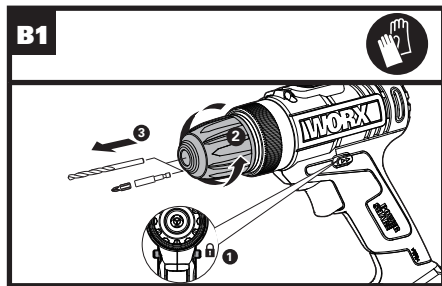
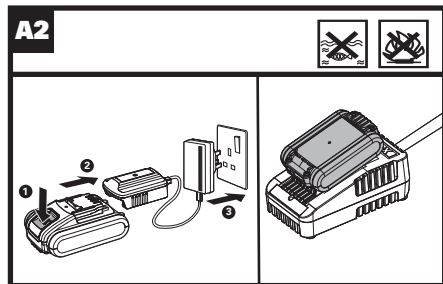
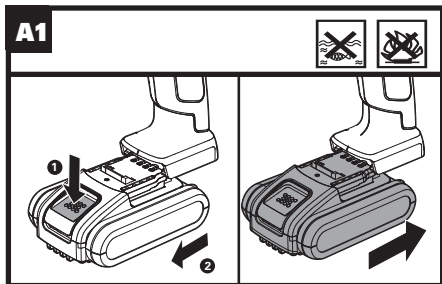

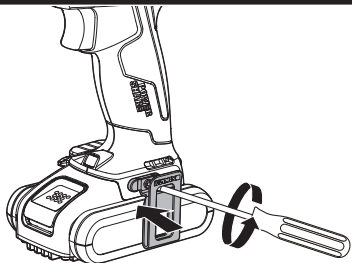
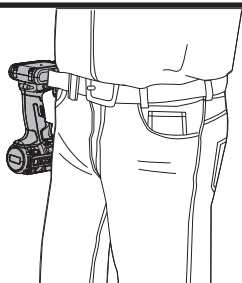
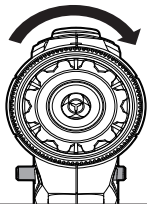
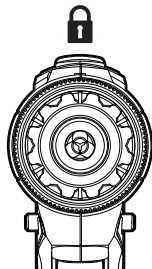
C1**C2****D1****D2**

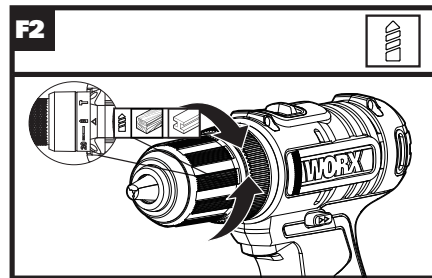
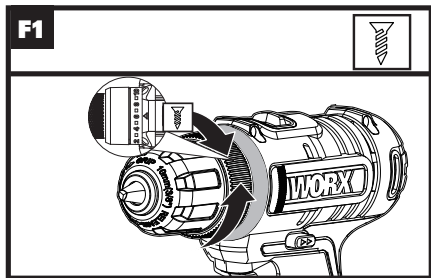
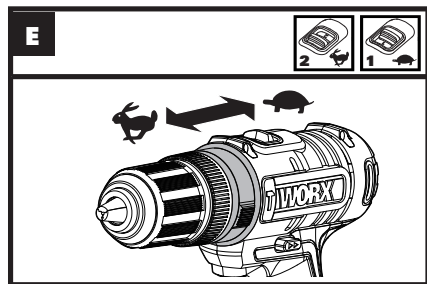
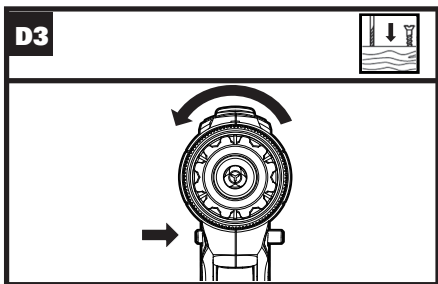

F3**G**

TABLE OF CONTENT

1. SAFETY INSTRUCTIONS
2. COMPONENT LIST
3. TECHNICAL DATA
4. INTENDED USE
5. OPERATING INSTRUCTIONS
6. TROUBLESHOOTING
7. MAINTENANCE
8. ENVIRONMENTAL PROTECTION
9. DECLARATION OF CONFORMITY

1. PRODUCT SAFETY

GENERAL POWER TOOL SAFETY WARNINGS

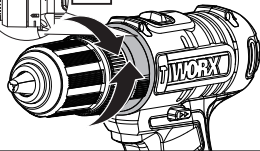
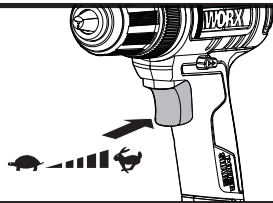

WARNING Read all safety warnings, instructions, illustrations and specifications provided with this power tool. Failure to follow all instructions listed below may result in electric shock, fire and/or serious injury. Save all warnings and instructions for future reference.

The term "power tool" in the warnings refers to your mains-operated (corded) power tool or battery-operated (cordless) power tool.

1) Work area safety

- a) Keep work area clean and well lit.** *Cluttered or dark areas invite accidents.*
 - b) Do not operate power tools in explosive atmospheres, such as in the presence of flammable liquids, gases or dust.** *Power tools create sparks which may ignite the dust or fumes.*
 - c) Keep children and bystanders away while operating a power tool.** *Distractions can cause you to lose control.*
- 2) Electrical safety**
- a) Power tool plugs must match the outlet. Never modify the plug in any way. Do not use any adapter plugs with earthed (grounded) power tools.** *Unmodified plugs and matching outlets will reduce risk of electric shock.*
 - b) Avoid body contact with earthed or grounded surfaces, such as pipes, radiators, ranges and refrigerators.** *There is an increased risk of electric shock if your body is earthed or grounded.*
 - c) Do not expose power tools to rain or wet conditions.** *Water entering a power tool will increase the risk of electric shock.*
 - d) Do not abuse the cord. Never use the cord for carrying, pulling or unplugging the power tool. Keep cord away from heat, oil, sharp edges or moving parts.** *Damaged or entangled cords increase the risk of electric shock.*
 - e) When operating a power tool outdoors, use an extension cord suitable for outdoor use.** *Use of a cord suitable for outdoor use reduces the risk of electric shock.*

- f) If operating a power tool in a damp location is unavoidable, use a residual current device (RCD) protected supply.** *Use of an RCD reduces the risk of electric shock.*
- 3) Personal safety**
- a) Stay alert, watch what you are doing and use common sense when operating a power tool. Do not use a power tool while you are tired or under the influence of drugs, alcohol or medication.** *A moment of inattention while operating power tools may result in serious personal injury.*
- b) Use personal protective equipment. Always wear eye protection.** *Protective equipment such as dust mask, non-skid safety shoes, hard hat, or hearing protection used for appropriate conditions will reduce personal injuries.*
- c) Prevent unintentional starting. Ensure the switch is in the off-position before connecting to power source and/or battery pack, picking up or carrying the tool.** *Carrying power tools with your finger on the switch or energising power tools that have the switch on invites accidents.*
- d) Remove any adjusting key or wrench before turning the power tool on.** *A wrench or a key left attached to a rotating part of the power tool may result in personal injury.*
- e) Do not overreach. Keep proper footing and balance at all times.** *This enables better control of the power tool in unexpected situations.*
- f) Dress properly. Do not wear loose clothing or jewellery. Keep your hair and clothing away from moving parts.** *Loose clothes, jewellery or long hair can be caught in moving parts.*
- g) If devices are provided for the connection of dust extraction and collection facilities, ensure these are connected and properly used.** *Use of dust collection can reduce dust-related hazards.*
- h) Do not let familiarity gained from frequent use of tools allow you to become complacent and ignore tool safety principles.** *A careless action can cause severe injury within a fraction of a second.*
- 4) Power tool use and care**
- a) Do not force the power tool. Use the correct power tool for your application.** *The correct power tool will do the job better and safer at the rate for which it was designed.*
- b) Do not use the power tool if the switch does not turn it on and off.** *Any power tool that cannot be controlled with the switch is dangerous and must be repaired.*
- c) Disconnect the plug from the power source and/or remove the battery pack, if detachable, from the power tool before making any adjustments, changing accessories, or storing power tools.** *Such preventive safety measures reduce the risk of starting the power tool accidentally.*
- d) Store idle power tools out of the reach of children and do not allow persons unfamiliar with the power tool or these instructions to operate the power tool.** *Power tools are dangerous in the hands of untrained users.*
- e) Maintain power tools and accessories. Check for**

misalignment or binding of moving parts, breakage of parts and any other condition that may affect the power tool's operation. If damaged, have the power tool repaired before use. *Many accidents are caused by poorly maintained power tools.*

- f) **Keep cutting tools sharp and clean.** *Properly maintained cutting tools with sharp cutting edges are less likely to bind and are easier to control.*
- g) **Use the power tool, accessories and tool bits etc. in accordance with these instructions, taking into account the working conditions and the work to be performed.** *Use of the power tool for operations different from those intended could result in a hazardous situation.*
- h) **Keep handles and grasping surfaces dry, clean and free from oil and grease.** *Slippery handles and grasping surfaces do not allow for safe handling and control of the tool in unexpected situations.*

5) Battery tool use and care

- a) **Recharge only with the charger specified by the manufacturer.** *A charger that is suitable for one type of battery pack may create a risk of fire when used with another battery pack.*
- b) **Use power tools only with specifically designated battery packs.** *Use of any other battery packs may create a risk of injury and fire.*
- c) **When battery pack is not in use, keep it away from other metal objects, like paper clips, coins, keys, nails, screws or other small metal objects, that can make a connection from one terminal to another.** *Shorting the battery terminals together may cause burns*

or a fire.

- d) **Under abusive conditions, liquid may be ejected from the battery; avoid contact. If contact accidentally occurs, flush with water. If liquid contacts eyes, additionally seek medical help.** *Liquid ejected from the battery may cause irritation or burns.*
 - e) **Do not use a battery pack or tool that is damaged or modified.** *Damaged or modified batteries may exhibit unpredictable behaviour resulting in fire, explosion or risk of injury.*
 - f) **Do not expose a battery pack or tool to fire or excessive temperature.** *Exposure to fire or temperature above 130 °C may cause explosion.*
 - g) **Follow all charging instructions and do not charge the battery pack or tool outside the temperature range specified in the instructions.** *Charging improperly or at temperatures outside the specified range may damage the battery and increase the risk of fire.*
- #### **6) Service**
- a) **Have your power tool serviced by a qualified repair person using only identical replacement parts.** *This will ensure that the safety of the power tool is maintained.*
 - b) **Never service damaged battery packs.** *Service of battery packs should only be performed by the manufacturer or authorized service providers.*

DRILL SAFETY WARNINGS

1) Safety instructions for all operations

a) **Wear ear protectors when impact drilling.** *Exposure to noise can cause hearing loss.*

b) **Hold the power tool by insulated gripping surfaces, when performing an operation where the cutting accessory or fasteners may contact hidden wiring.**

Cutting accessory or fasteners contacting a "live" wire may make exposed metal parts of the power tool "live" and could give the operator an electric shock.

2) Safety instructions when using long drill bits

a) **Never operate at higher speed than the maximum speed rating of the drill bit.** At higher speeds, the bit is likely to bend if allowed to rotate freely without contacting the workpiece, resulting in personal injury.

b) **Always start drilling at low speed and with the bit tip in contact with the workpiece.** At higher speeds, the bit is likely to bend if allowed to rotate freely without contacting the workpiece, resulting in personal injury.

c) **Apply pressure only in direct line with the bit and do not apply excessive pressure.** Bits can bend causing breakage or loss of control, resulting in personal injury.

SAFETY WARNINGS FOR BATTERY PACK

a) **Do not dismantle, open or shred cells.**

b) **Do not short-circuit charging terminal. Do not store**

power tool haphazardly in a box or drawer where charging terminal may short-circuit each other or be short-circuited by conductive materials.

When battery pack is not in use, keep it away from other metal objects, like paper clips, coins, keys, nails, screws or other small metal objects, that can make a connection from one charging terminal to another. Shorting the battery terminals together may cause burns or a fire.

c) **Do not expose power tool to heat or fire. Avoid storage in direct sunlight.**

d) **Do not subject power tool to mechanical shock.**

e) **In the event of battery leaking, do not allow the liquid to come into contact with the skin or eyes. If contact has been made, wash the affected area with copious amounts of water and seek medical advice.**

f) **Keep power tool clean and dry.**

g) **Wipe the charging terminals with a clean dry cloth if they become dirty.**

h) **Battery pack needs to be charged before use.**

Always refer to this instruction and use the correct charging procedure.

i) **Do not maintain power tool on charge when not in use.**





j) **After extended periods of storage, it may be necessary to charge and discharge the power tool several times to obtain maximum performance.**



k) **Recharge only with the charger specified by Worx. Do not use any charger other than that specifically provided for use with the equipment.**

l) **Do not use any battery pack which is not designed for use with the equipment.**

- m) **Keep battery pack out of the reach of children.**
- n) **Retain the original product literature for future reference.**
- o) **Remove the battery from the equipment when not in use.**
- p) **Dispose of properly.**
- q) **Do not mix cells of different manufacture, capacity, size or type within a device.**
- r) **Keep the battery away from microwaves and high pressure.**

SYMBOLS

	To reduce the risk of injury, user must read instruction manual
	Warning
	Wear ear protection
	Wear eye protection

	Wear dust mask
	Batteries may enter water cycle if disposed improperly, which can be hazardous for ecosystem. Do not dispose of waste batteries as unsorted municipal waste.
	Do not burn
	Waste electrical products must not be disposed of with household waste. Please recycle where facilities exist. Check with your local authorities or retailer for recycling advice.



Li-Ion



Li-Ion battery. This product has been marked with a symbol relating to 'separate collection' for all battery packs and battery pack. It will then be recycled or dismantled in order to reduce the impact on the environment. Battery packs can be hazardous for the environment and for human health since they contain hazardous substances.



Li-Ion



Li-Ion



Wear protective gloves.



Lock



Screw driving



Drilling



Hammer drilling



Wood



Metal



Masonry



High speed



Low speed



RCM marking

ABN: Australian Business Number. By this number, business information such as entity type, status, business location etc. can be found at website <http://abr.business.gov.au>.

ABN of Positec Australia Pty Limited is 14 101 682 357

2.COMPONENT LIST

1. **KEYLESS CHUCK**
2. **TORQUE ADJUSTMENT RING**
3. **TWO-SPEED GEAR CONTROL**
4. **FORWARD/REVERSE ROTATION CONTROL**
5. **SOFT GRIP HANDLE**
6. **BATTERY PACK ***
7. **BATTERY PACK RELEASE BUTTON ***
8. **ON/OFF SWITCH**

9. **LED LIGHT**

10. **BELT HOOK**

*** Not all the accessories illustrated or described are included in standard delivery.**

3.TECHNICAL DATA

Type designation **WX100 WX100.X WX108 WX108.X (1-designation of machinery, representative of hand hold drill)**
WX370 WX370.X (3- designation of machinery, representative of Hammer Drill)

		WX100 WX100.X **	WX108 WX108.X **	WX370 WX370.X **
Rated voltage	20V \equiv Max***			
No-load speed	0-400/0-1600/min			0-400/0-1600/ min
Impact rate	/	/	0-6800/0-27200/min	
Number of clutch position	20+1			20+1+1
Max torque	30Nm	45Nm	50Nm	
Chuck capacity	10mm	13mm	13mm	
Max. drilling capacity	Wood	25mm	40mm	40mm
	Metal	10mm	13mm	13mm
	Masonry	/	/	13mm
Machine weight (bare tool)	0.78kg	0.81kg	1kg	

** X=1-999,A-Z,M1-M9 they are only used for different customers, there are no safe relevant changes between these models

*** Voltage measured without workload. Initial battery voltage reaches maximum of 20 volts. Nominal voltage is 18 volts.

Category	Model	Capacity
20V Battery	WA3551	2.0Ah
	WA3551.1	2.0Ah
20V Charger	WA3760	0.4A
	WA3880	2.0A

We recommend that you purchase your accessories listed in the above list from the same store that sold you the tool. Refer to the accessory packaging for further details. Store personnel can assist you and offer advice.

NOISE INFORMATION

	WX100 WX100.X	WX108 WX108.X WX370 WX370.X
A weighted sound pressure	L_{pA} : 78.9dB(A)	L_{pA} : 90.5dB(A)
A weighted sound power	L_{wA} : 89.9dB(A)	L_{wA} : 101.5dB(A)
K_{pA} & K_{wA}	5.0dB(A)	5.0dB(A)

Wear ear protection.

VIBRATION INFORMATION

Vibration total values (triax vector sum) determined according to EN 62841:

WX100 WX100.X	Drilling into metal	Vibration emission value $a_{h,D} = 1.996 \text{ m/s}^2$
		Uncertainty $K = 1.5 \text{ m/s}^2$
WX108 WX108.X WX370 WX370.X	Drilling into metal	Vibration emission value $a_{h,D} = 1.926 \text{ m/s}^2$
		Uncertainty $K = 1.5 \text{ m/s}^2$
WX370 WX370.X	Impact drilling into concrete	Vibration emission value $a_{h,D} = 12.294 \text{ m/s}^2$
		Uncertainty $K = 1.5 \text{ m/s}^2$

The declared vibration total value and the declared noise emission value have been measured in accordance with a standard test method and may be used for comparing one tool with another.

The declared vibration total value and the declared noise emission value may also be used in a preliminary assessment of exposure.



WARNING: The vibration and noise emissions during actual use of the power tool can differ from the declared value depending on the ways in which the tool is used especially what kind of workpiece is processed dependant on the following examples and other variations on how the tool is used:

How the tool is used and the materials being cut or drilled.
The tool being in good condition and well maintained.
The use of the correct accessory for the tool and ensuring it is sharp and in good condition.
The tightness of the grip on the handles and if any anti vibration and noise accessories are used.
And the tool is being used as intended by its design and these instructions.

This tool may cause hand-arm vibration syndrome if its use is not adequately managed.



WARNING: To be accurate, an estimation of exposure level in the actual conditions of use should also take account of all parts of the operating cycle such as the times when the tool is switched off and when it is running idle but not actually doing the job. This may significantly reduce the exposure level over the total working period.

Helping to minimise your vibration and noise exposure risk. Always use sharp chisels, drills and blades.

Maintain this tool in accordance with these instructions and keep well lubricated (where appropriate).

If the tool is to be used regularly then invest in anti vibration and noise accessories.

Plan your work schedule to spread any high vibration tool use across a number of days.

4. INTENDED USE

WX100 WX100.X WX108 WX108.X

The machine is intended for driving in and loosening

screws as well as for drilling in wood, metal and plastic.

WX370 WX370.X

The machine is intended for impact drilling in brick, concrete and stone as well as for drilling in wood, metal and plastic.

5. OPERATING INSTRUCTIONS



NOTE: Before using the tool, read the instruction book carefully.



ASSEMBLY AND OPERATION

ACTION	FIGURE
BEFORE OPERATION	
Removing & Installing the battery pack	See Fig. A1
Charging the battery pack	See Fig. A2,
ASSEMBLY	

CHUCK ADJUSTMENT



WARNING: Always lock off trigger switch and disconnect tool from power source when changing accessories. Always ensure the bit is secure before starting the tool. Damage to the Chuck or a loose bit may cause possible personal injury.

--Removing the bits	See Fig. B1
--Inserting the bits	See Fig. B2
-- Assembling the belt hook	See Fig. C1, C2
OPERATION	
FORWARD/REVERSE ROTATION CONTROL  WARNING: Never change the direction of rotation when the chuck is rotating, wait until it has stopped!	See Fig.D1, D2,D3
TWO-SPEED GEAR CONTROL	See Fig. E
TORQUE ADJUSTMENT SCREWDRIVING, DRILLING, HAMMER DRILLING	See Fig.F1, F2, F3
OPERATING THE ON/OFF SWITCH  WARNING: Do not operate for long periods at low speed because excess heat will be produced internally.	See Fig. G

LED LIGHT INDICATOR (See Fig. G)

To turn on the light, press the on/off switch and make sure the forward/reverse rotation control is on right/left position. When you release the on/off switch, the light will be off. LED lighting increases visibility-great for dark or enclosed

area. LED is also a battery capacity indicator. It will flash when power gets low.

The tool and battery pack are equipped with a protection system. When the LED Light is quickly flashing and turn off, the system will automatically cut off power to the tool to extend battery life. The tool will automatically stop during operation if the tool and/or battery pack are placed under one of the following conditions:

- **Overloaded:** The tool is operated in a manner that causes it to draw an abnormally high current. In this situation, release the Trigger Switch on the tool and stop the application that caused the tool to become overloaded. Then pull the Trigger Switch again to restart.

- **Overheated:** Under the condition above, if the tool does not start, the Tool and Battery Pack are overheated. In this situation, let the Tool and Battery Pack cool before pulling the Trigger Switch again.

- **Low battery voltage:** The remaining Battery capacity is too low and the tool will not operate. In this situation, remove and recharge the Battery Pack.

6.PROBLEM SOLUTION

(1) WHY DOES THE DRILL NOT TURN ON WHEN YOU PRESS THE SWITCH?

The forward/reverse rotation control, which is on top of the trigger, is positioned in the lock function. Unlock the forward/reverse rotation control by putting it into the required rotation position. Push the trigger and the drill will start to rotate.Check that the battery is charged and properly connected to the tool.

(2) THE DRILL STOPS BEFORE THE SCREW IS COMPLETELY TIGHTENED. WHY?

Verify the torque position of the torque adjusting ring. Find the torque adjusting ring between the chuck and the drill body. Position 1 is the lowest torque (screw driving force) and position 20 is the highest torque (screw driving force). Position 1 is for drill operation. Regulate the torque adjusting ring to a higher position to reach the best result.

(3) I CAN NOT FIT THE BATTERY PACK INTO THE BATTERY CHARGER. WHY?

The battery pack can be inserted into the charger only in one direction. Turn the battery pack around until it can be inserted into the slot. The charger LED indicator should turn on when the battery pack is charging.

(4) REASONS FOR DIFFERENT BATTERY PACK WORKING TIMES

Charging time problems, as above, and having not used a battery pack for a prolonged time will reduce the battery pack working time. This can be corrected after several charge and discharge operations by charging & working with your drill. Heavy working conditions such as large screws into hard wood will use up the battery pack energy faster than lighter working conditions. Do not re-charge your battery pack below 0°C and above 45°C as this will affect performance.

7.MAINTENANCE

Remove the battery pack from the tool before carrying out any adjustment, servicing or

maintenance.

Your tool requires no additional lubrication or maintenance. There are no user serviceable parts in your power tool. Never use water or chemical cleaners to clean your power tool. Wipe clean with a dry cloth. Always store your power tool in a dry place. Keep the motor ventilation slots clean. Keep all working controls free of dust. Occasionally you may see sparks through the ventilation slots. This is normal and will not damage your power tool.

FOR BATTERY TOOLS

The ambient temperature range for tool and battery use and storage is 0°C-45°C.

The recommended ambient temperature range for the charging system during charging is 0°C-40°C.

8.ENVIRONMENTAL PROTECTION



Waste electrical products must not be disposed of with household waste. Please recycle where facilities exist. Check with your local authorities or retailer for recycling advice.

Positec Australia Pty Limited
10 Corporate Blvd Bayswater, VIC 3153, Australia

9. DECLARATION OF CONFORMITY

We,
Positec Germany GmbH
Postfach 32 02 16, 50796 Cologne, Germany

Declare that the product

Description **Worx Drill Driver**

Type **WX100 WX100.X WX108 WX108.X(1- designation of machinery, representative of Battery-powered Drill)**

WX370 WX370.X(3- designation of machinery, representative of Hammer Drill)

Function **Drilling, tightening and loosening screws, nuts**

Complies with the following Directives:

2006/42/EC

2011/65/EU & (EU) 2015/863

2014/30/EU

Standards conform to

EN 55014-1, EN 55014-2

EN 62841-1, EN 62841-2-1

The person authorized to compile the technical file,

Name Marcel Filz

Address Positec Germany GmbH

Postfach 32 02 16, 50796 Cologne, Germany



2021/11/03

Allen Ding

Deputy Chief Engineer, Testing & Certification

Positec Technology (China) Co., Ltd

18, Dongwang Road, Suzhou Industrial

Park, Jiangsu 215123, P. R. China

DECLARATION OF CONFORMITY

We,
Positec Power Tools (Europe) Ltd,
PO Box 6242, Newbury, RG14 9LT, UK

On behalf of Positec declare that the product

Description **WORX Drill Driver**

Type **WX100 WX100.X WX108 WX108.X(1-
designation of machinery, representative of Battery-
powered Drill)**

**WX370 WX370.X(3- designation of machinery,
representative of Hammer Drill)**

Function **Drilling, tightening and loosening screws,
nuts**

Complies with the following Directives:

Supply of Machinery (Safety) Regulations 2008
Electromagnetic Compatibility Regulations 2016
The Restriction of the Use of Certain Hazardous
Substances in Electrical and Electronic Equipment
Regulations

Standards conform to:

BS EN 62841-1, BS EN 62841-2-1
BS EN 55014-1, BS EN 55014-2

The person authorized to compile the technical file,

Name Jim Kirkwood

**Address Positec Power Tools (Europe) Ltd,
PO Box 6242, Newbury, RG14 9LT, UK**



2021/11/03

Allen Ding

Deputy Chief Engineer, Testing & Certification
Positec Technology (China) Co., Ltd
18, Dongwang Road, Suzhou Industrial
Park, Jiangsu 215123, P. R. China



you've got the power

After-sales Service and Application

At www.worx.com you can order spare parts or arrange the
collection of a product in need of servicing or repair.

Tel. Service: 0345 202 9679

E-Mail: customerservices@worxtools.com

www.worx.com

Copyright © 2022, Positec. All Rights Reserved.
AR01636502