

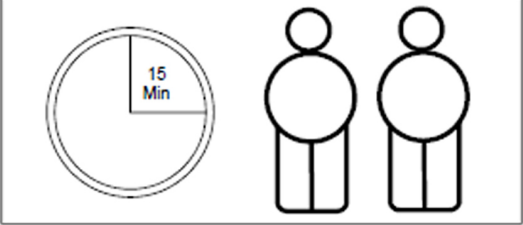



# ART.NR. 68160



## HARDWARE

A1	A2	A3	A4
 =X4	 =X8	 =X1	 =X8
LEGS	BOLT	ALLEN KEY	WHASHER

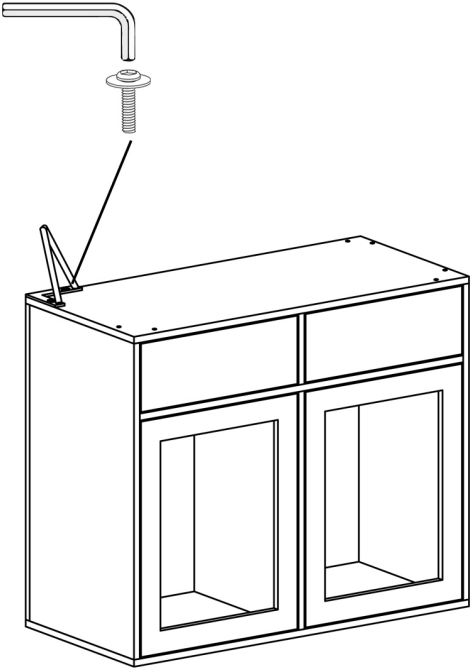

**STEP 1**

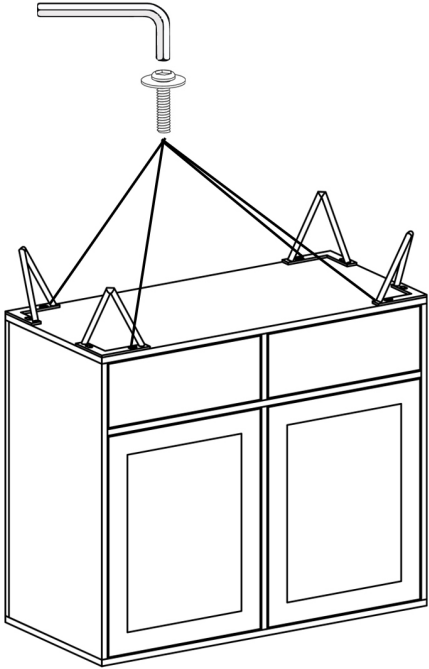

**STEP 2**

