

SCARLETT V

8100-0064/2503-0064  
2501-0064/8300-0064

**B/F**

191001

- |           |  |           |   |
|-----------|--|-----------|---|
| <b>D</b>  | MONTAGEANLEITUNG<br>BEDIENUNGSANLEITUNG                | <b>GB</b> | ASSEMBLY INSTRUCTIONS<br>INSTRUCTION MANUAL         |
| <b>NL</b> | HANDLEIDING VOOR DE MONTAGE<br>GEBRUIKSAANWIJZING      | <b>PL</b> | INSTRUKCJA MONTAŻU<br>INSTRUKCJA OBSŁUGI            |
| <b>TR</b> | MONTAJ TALIMATI<br>KULLANIM KLAVUZU                    | <b>RU</b> | ИНСТРУКЦИЯ ПО МОНТАЖУ<br>ИНСТРУКЦИЯ ПО ЭКСПЛУАТАЦИИ |
| <b>RO</b> | INSTRUCȚIUNI DE INSTALARE<br>INSTRUCȚIUNI DE UTILIZARE | <b>IT</b> | ISTRUZIONI DI MONTAGGIO<br>MANUALE DI ISTRUZIONI    |
| <b>FR</b> | NOTICE DE MONTAGE<br>MANUEL INSTRUCTIONS               | <b>SK</b> | MONTÁŽNY NÁVOD<br>NÁVOD NA POUŽITIE                 |
| <b>HU</b> | KÖZGYŰLÉS UTASÍTÁSOK<br>KEZELÉSI UTASÍTÁS              | <b>CZ</b> | MONTÁŽNÍ NÁVOD<br>NÁVOD K POUŽITÍ                   |
| <b>SI</b> | NAVODILA ZA MONTAŽO<br>NAVODILA ZA UPORABO             | <b>PT</b> | INSTRUÇÕES DE MONTAGEM<br>MANUAL DO USUÁRIO         |
| <b>ES</b> | INSTRUCCIONES DE MONTAJE<br>MANUAL DEL USUARIO         | <b>HR</b> | UPUTE ZA MONTAŽU<br>UPUTE ZA UPOTREBU               |

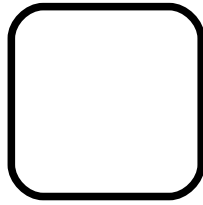
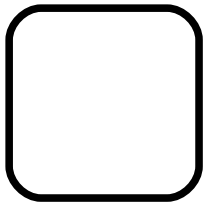

0019

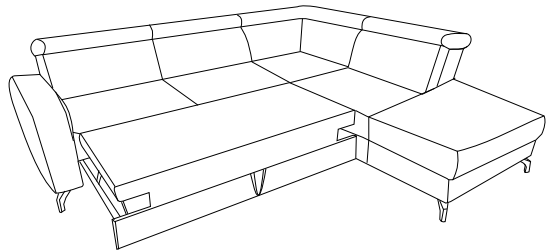
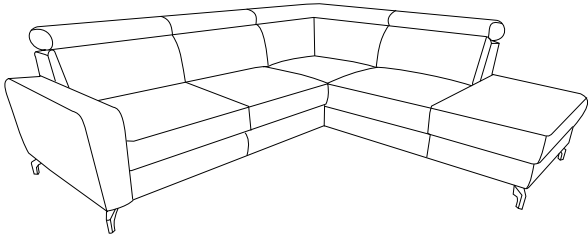

0019

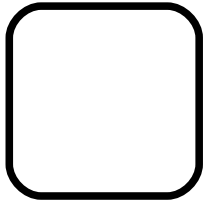
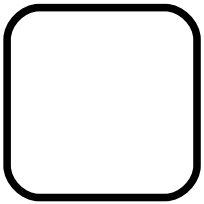

0088

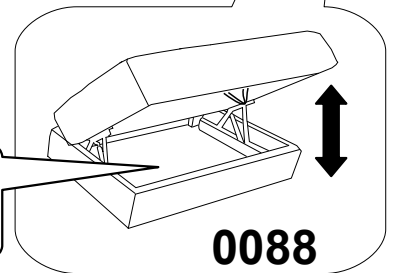
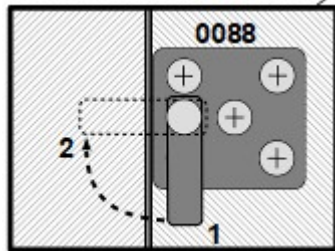
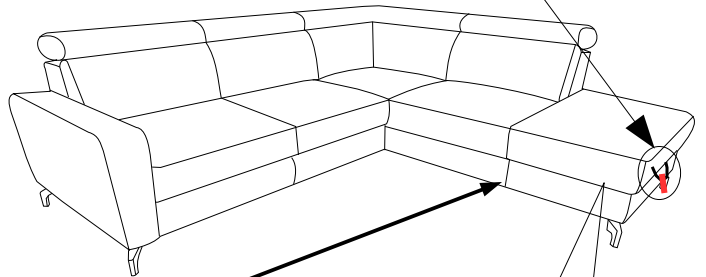
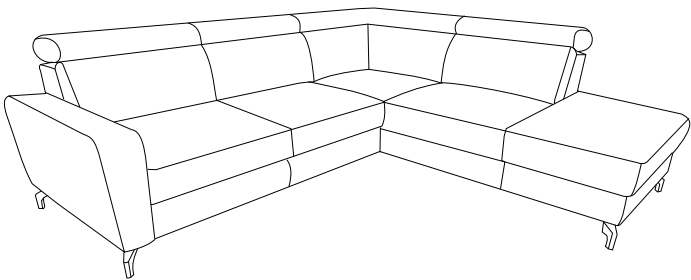
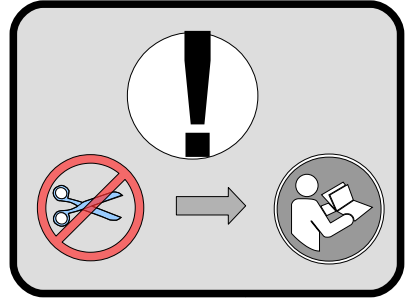





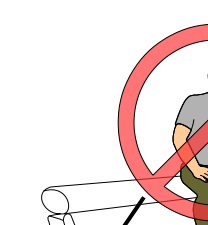

0088

L





R

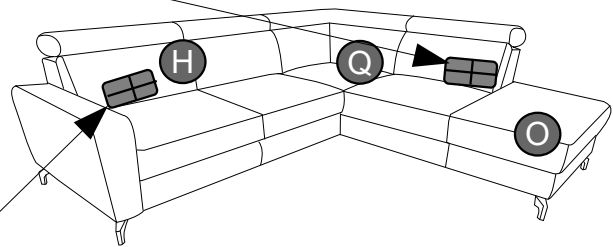
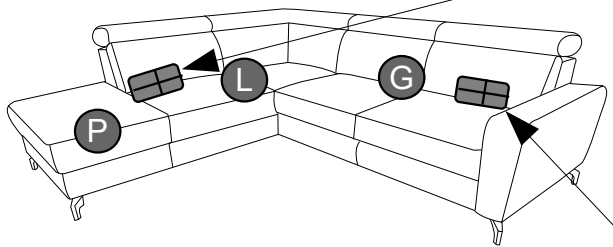

|  |  |  |  |  |      |
|--|--|--|--|--|------|
| <b>f</b> H- 120<br><br>X1 | <b>g</b> H- 120<br><br>X3 | <b>s</b> H- 120<br><br>S1<br>X3 | <b>q</b> M6*25<br><br>X12 | <b>i</b> L- 4<br><br>X1 | [mm] |
|--|--|--|--|--|------|





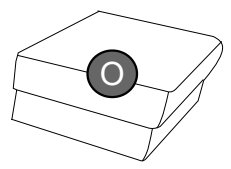
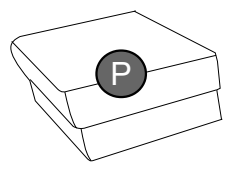
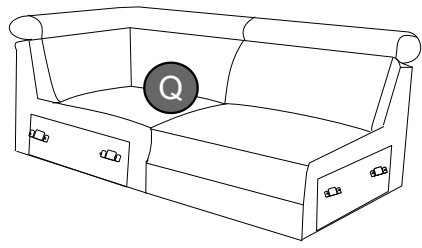
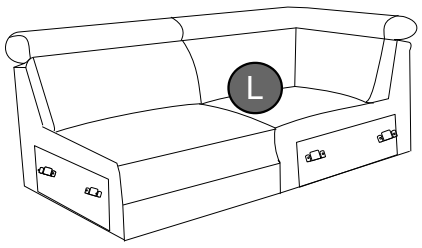
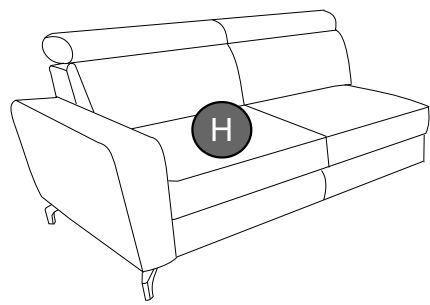
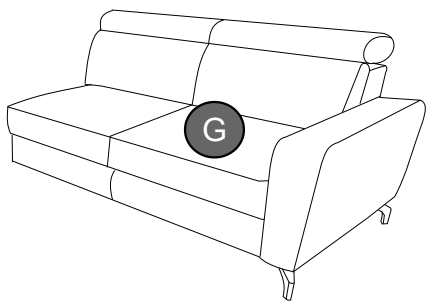

|  |   |  |
|--|---|--|
| <b>s</b> H- 120<br><br>S1<br>X2 | <b>q</b> M6*25<br><br>X8 | <b>i</b> L- 4<br><br>X1 |
|--|---|--|

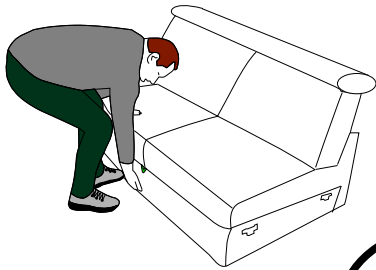

0  
10  
20  
30  
40  
50  
60  
70  
80  
90  
100  
110  
120  
130  
140  
150  
160  
170  
180  
190  
200







|  |   |  |
|--|---|--|
| <b>S</b> H- 120<br> | <b>q</b> M6*25<br> | <b>i</b> L- 4<br> |
| <b>S1</b><br>       |   |  |
| X2   | X8  | X1   |

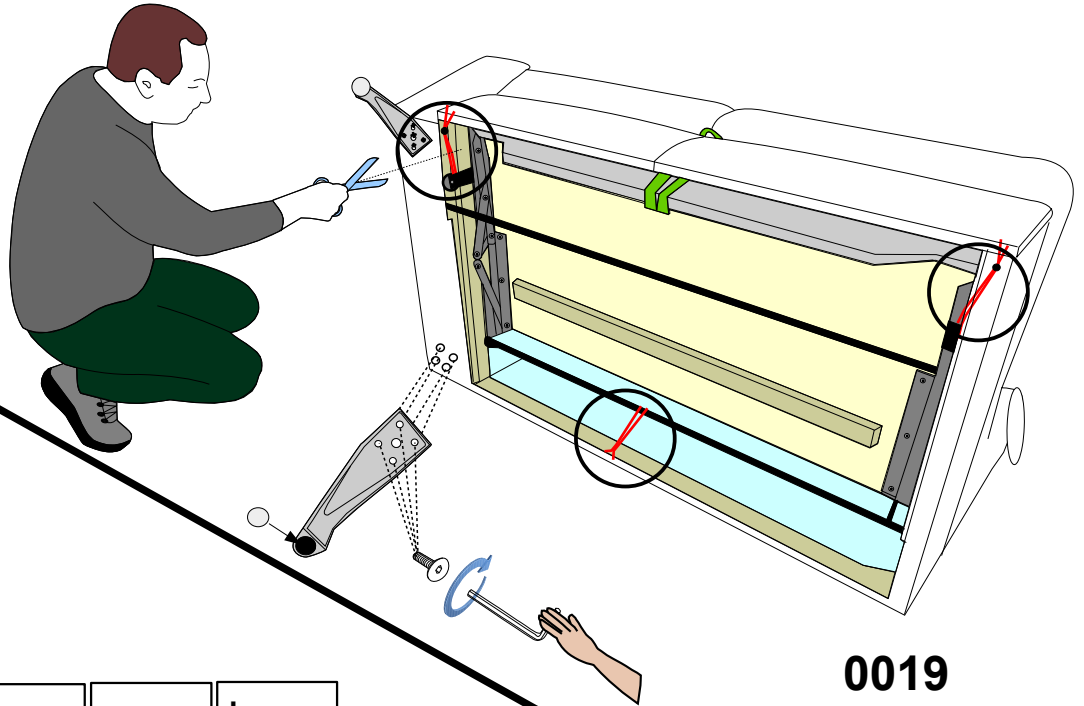







90°

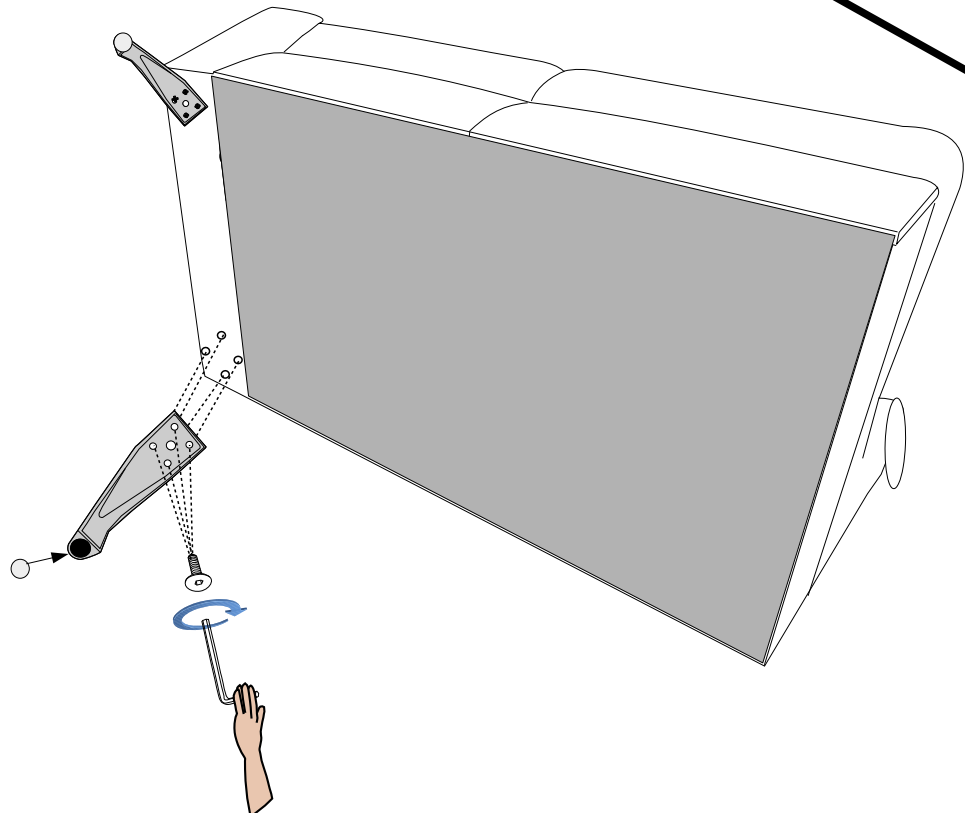





0019

|  |   |  |
|--|---|--|
| <b>S</b> H- 120<br> | <b>q</b> M6*25<br> | <b>i</b> L- 4<br> |
| <b>S1</b><br>       |   |  |
| X2   | X8  | X1   |

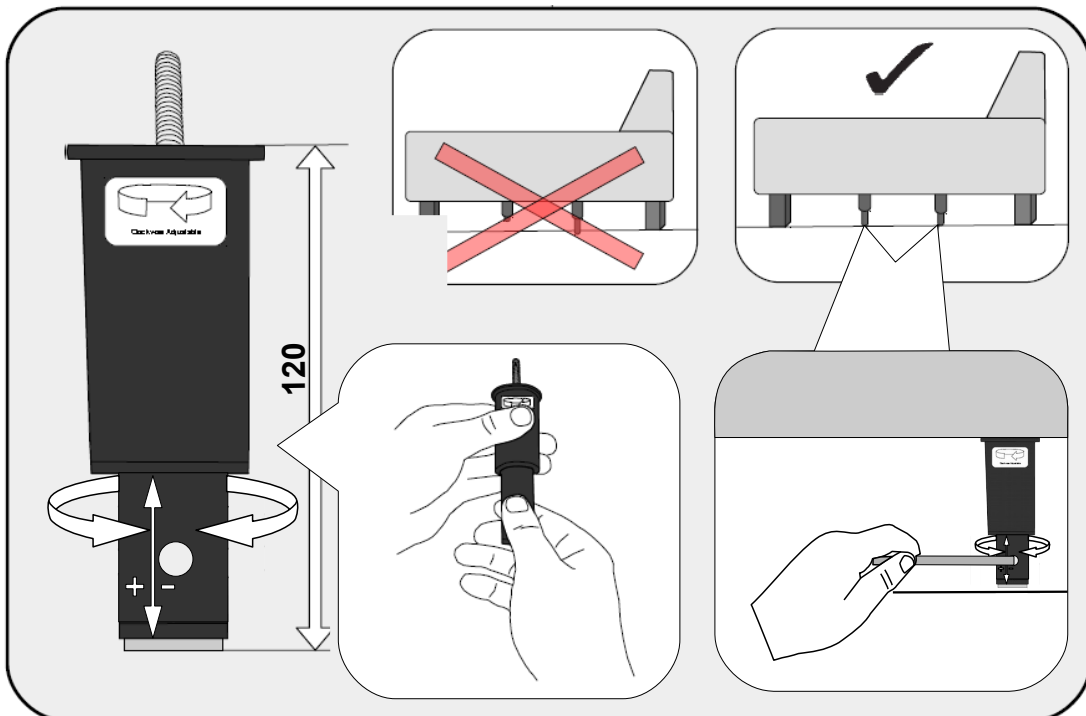
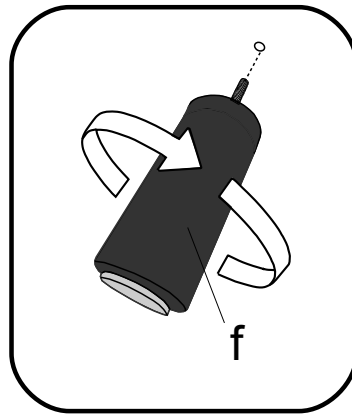
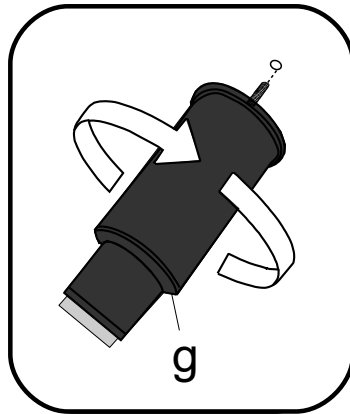
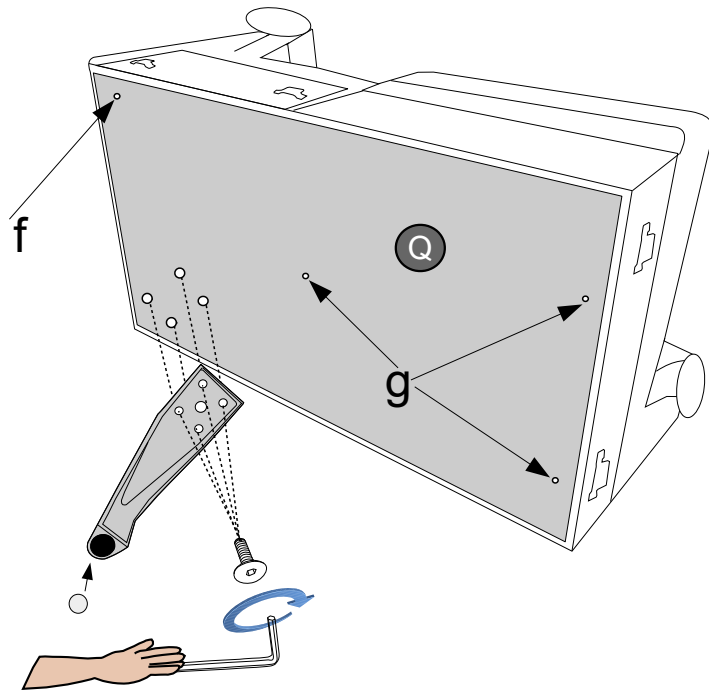
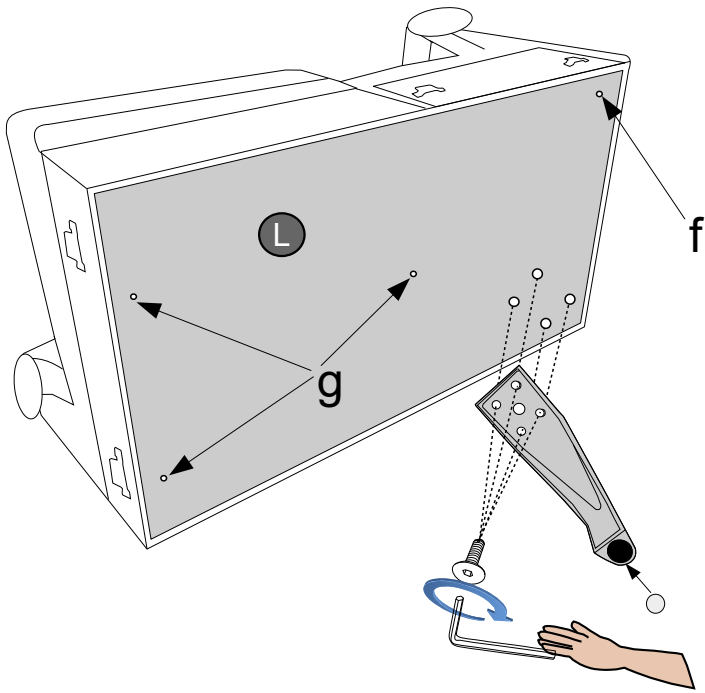

|   |  |   |   |   |
|---|--|---|---|---|
| <b>s</b> H- 120<br> | <b>q</b> M6*25<br> | <b>i</b> L- 4<br> | <b>f</b> H- 120<br> | <b>g</b> H- 120<br> |
| <b>S1</b> ○<br>    |  |   |   |   |
| X1  | X4   | X1  | X1  | X3  |



|   |  |   |
|---|--|---|
| <b>s</b> H- 120<br> | <b>q</b> M6*25<br> | <b>i</b> L- 4<br> |
| <b>s1</b>          |  |   |
| X2  | X8   | X1  |

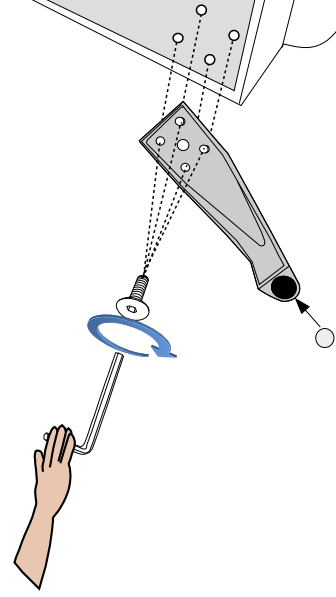
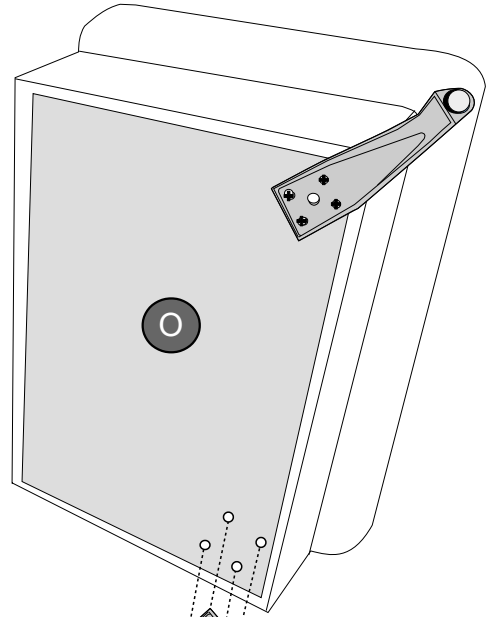
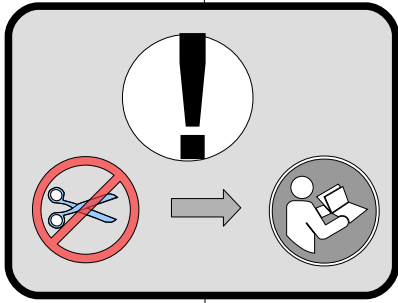
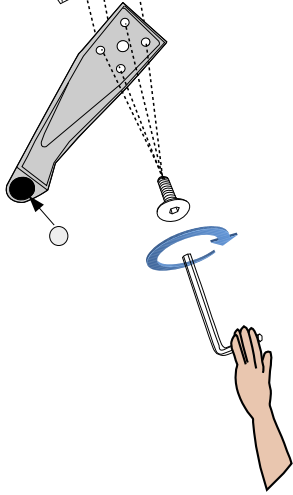
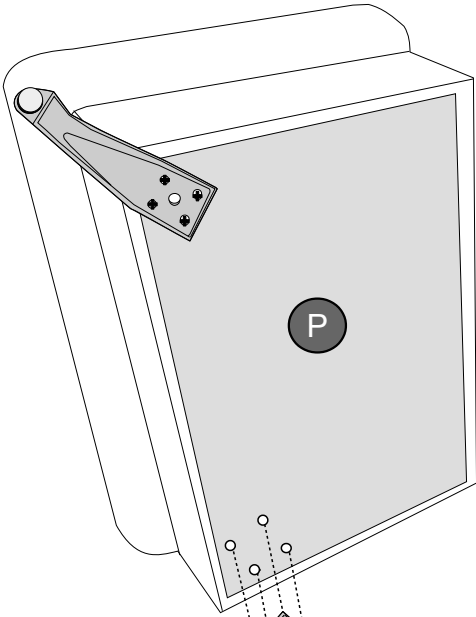

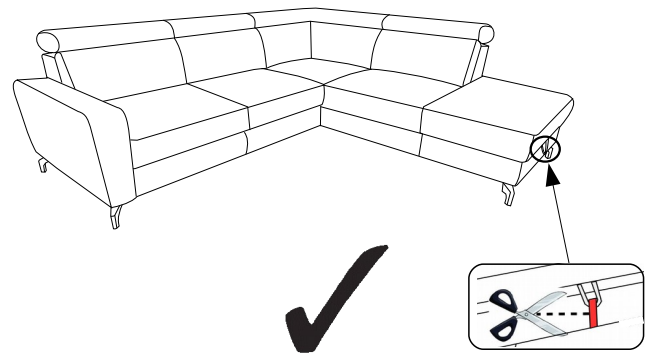
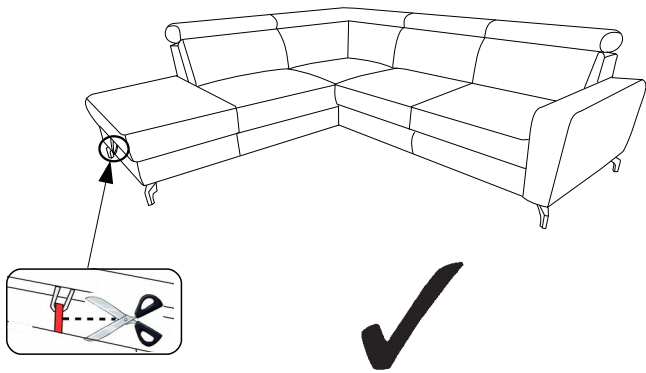
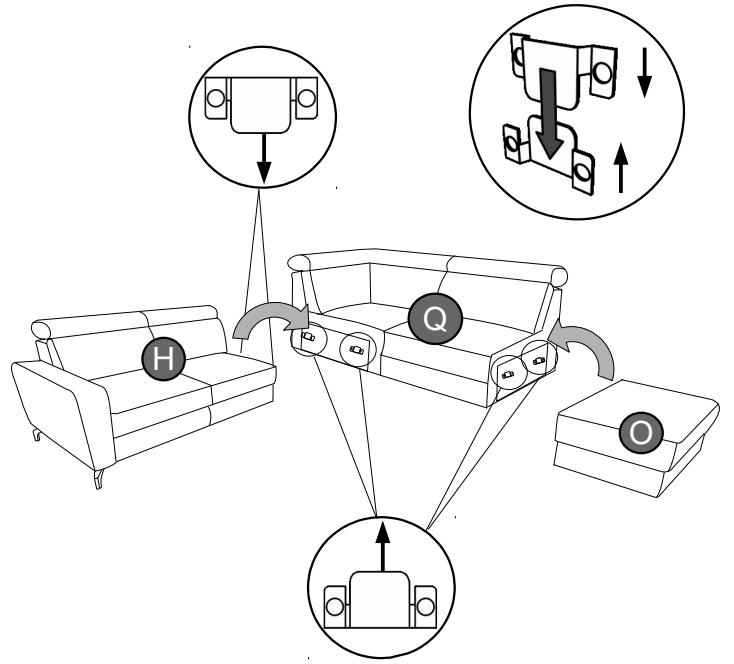
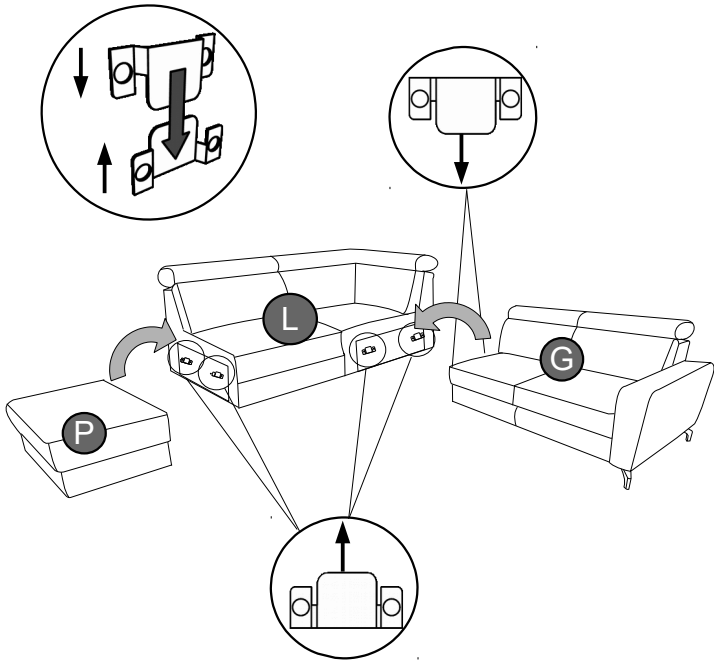
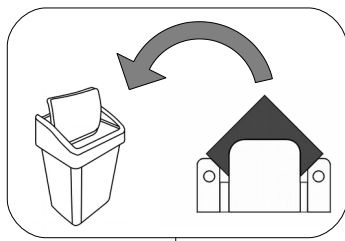

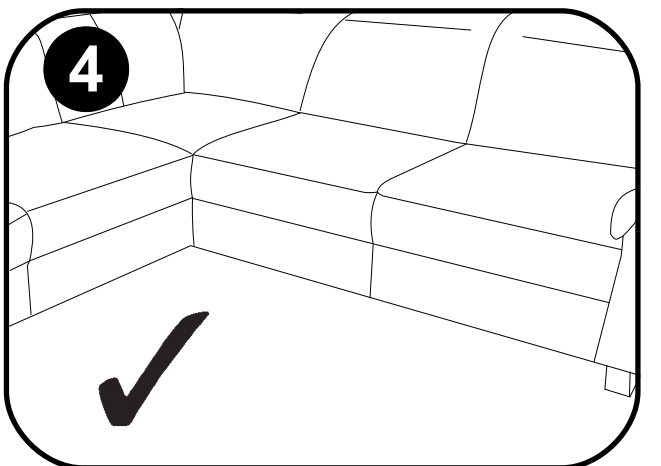
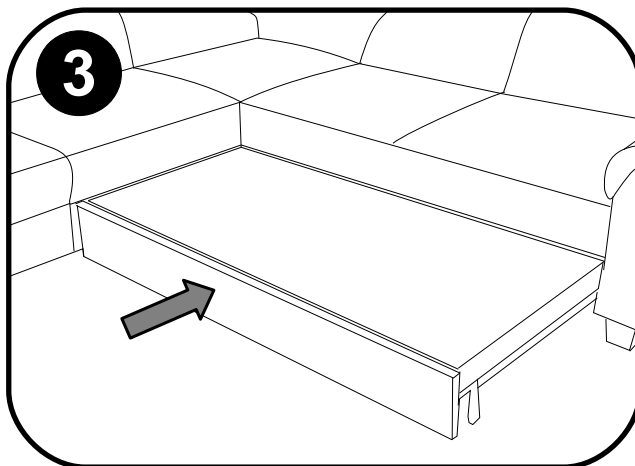
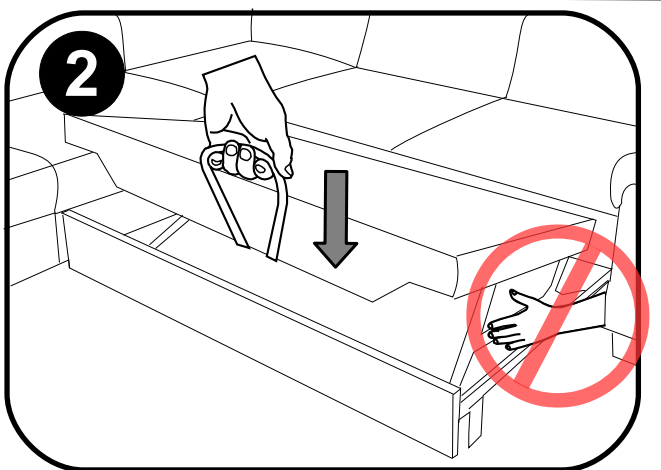
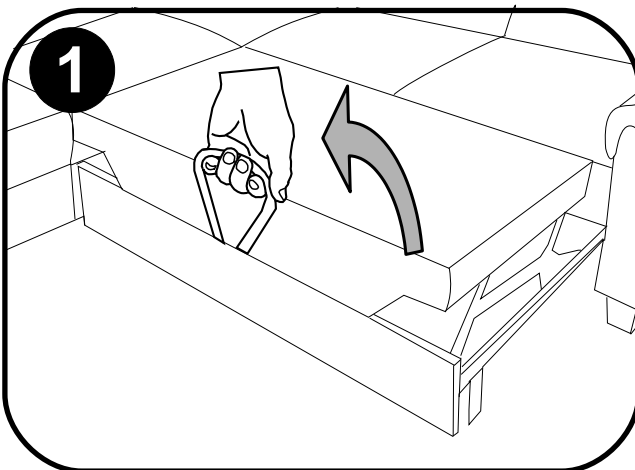
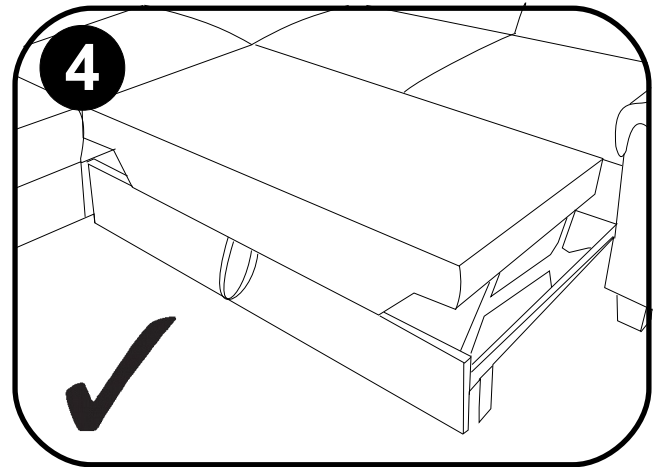
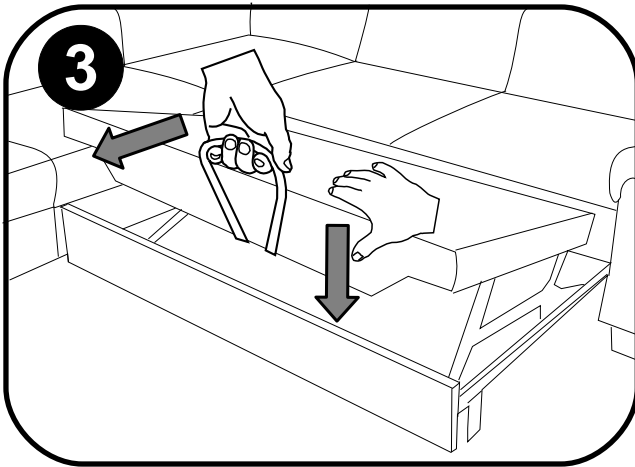
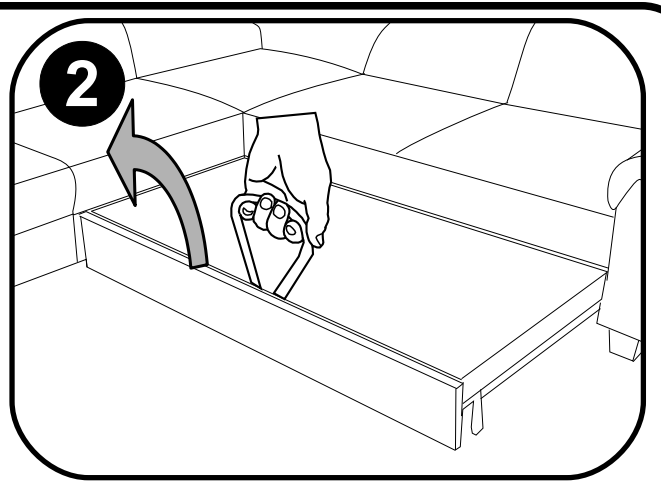
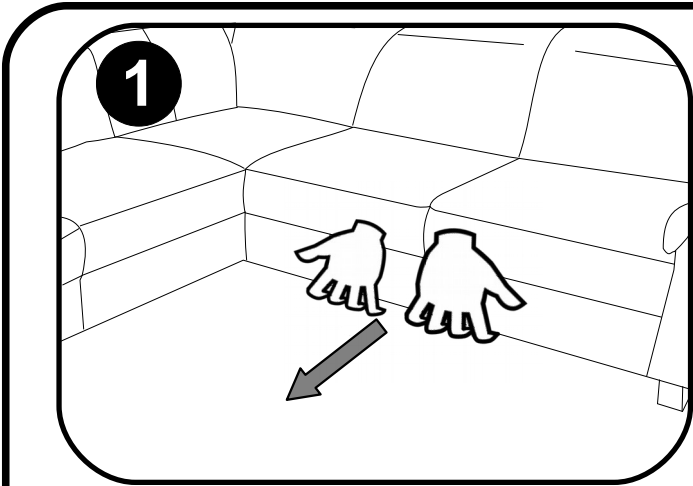
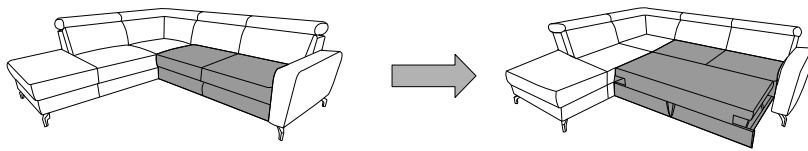



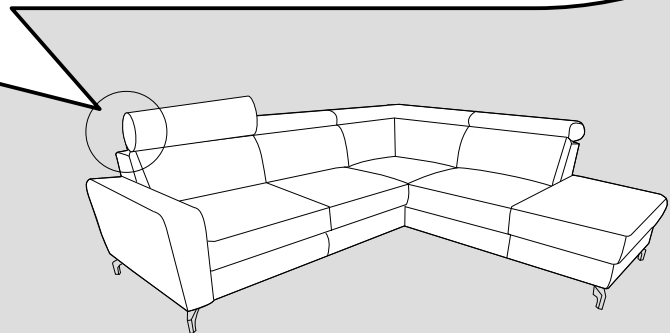
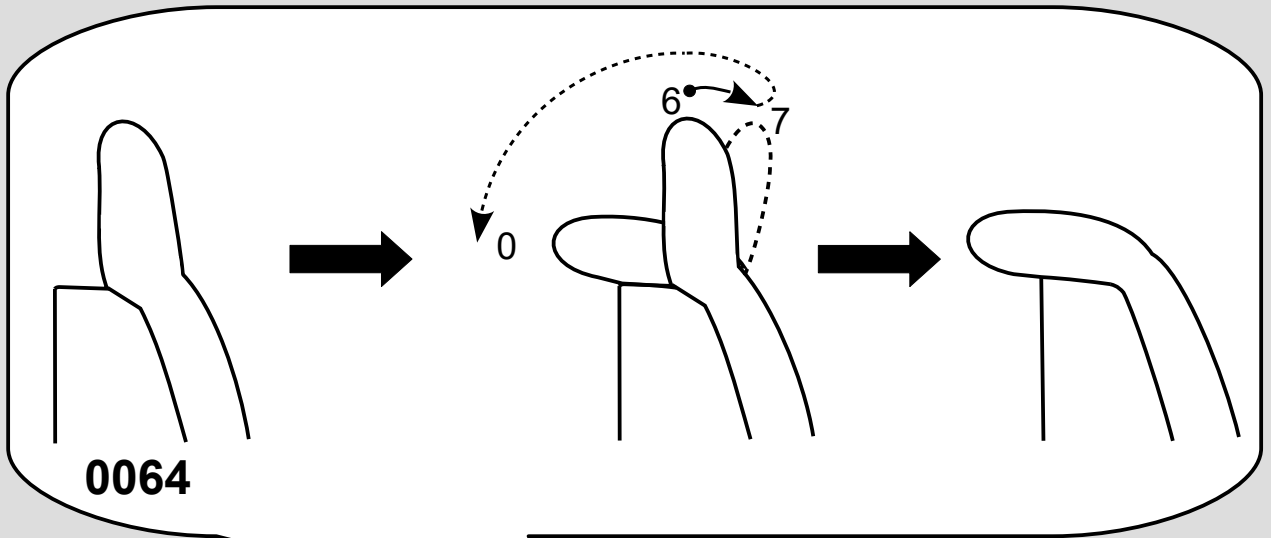
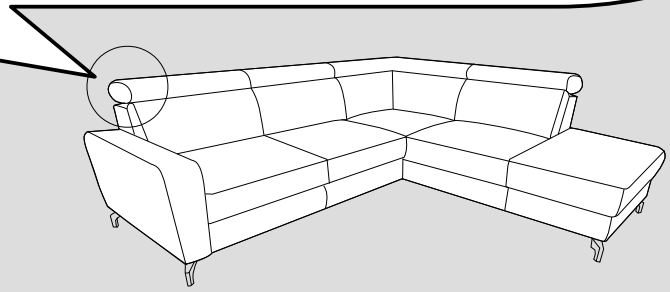
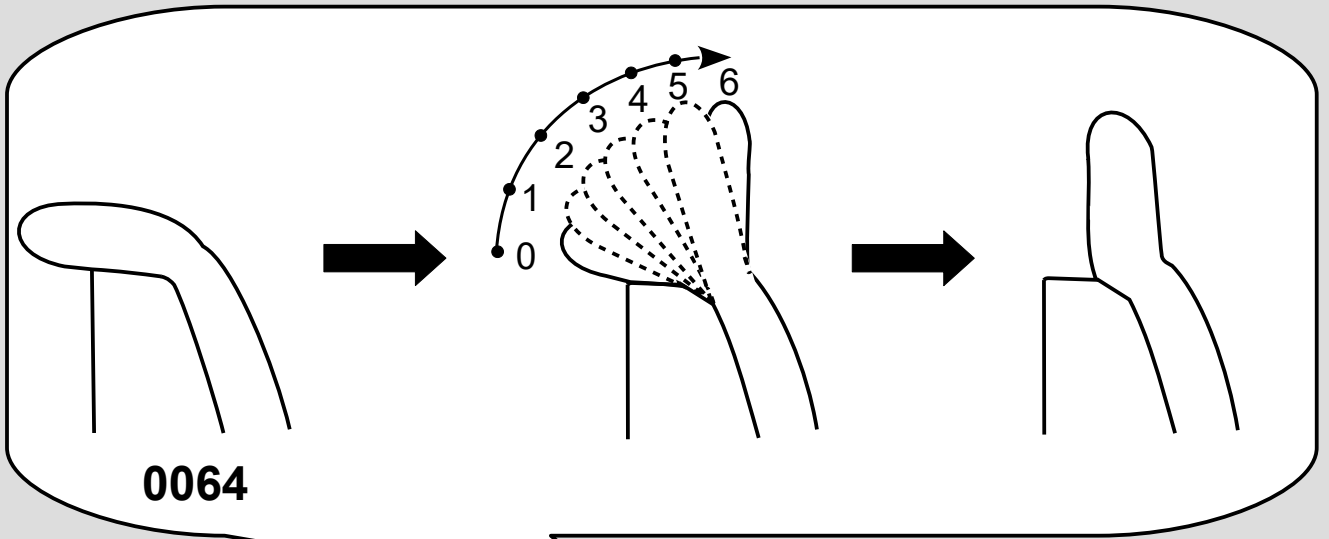

Name · Naam · Nazwa · İsim · Название · Nume · Nome · Název · Názov ·  
 Název · Neve

**SCARLETT V**



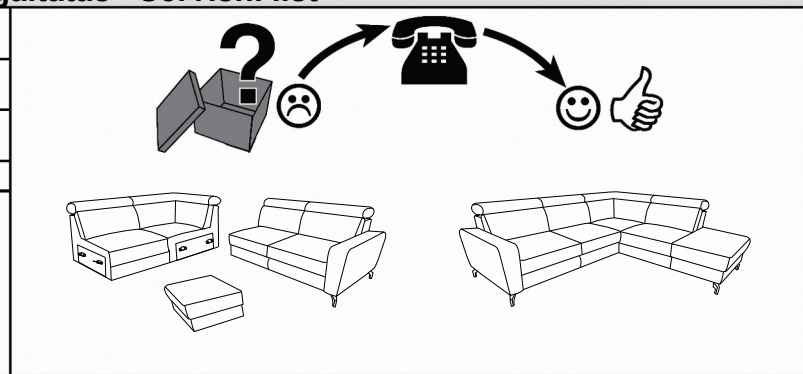
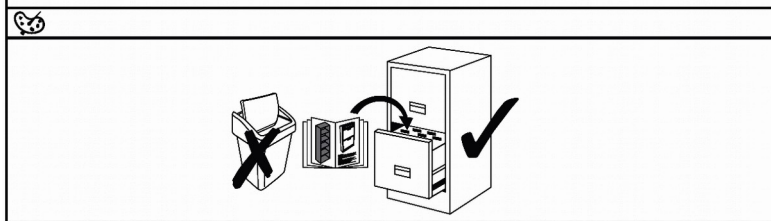





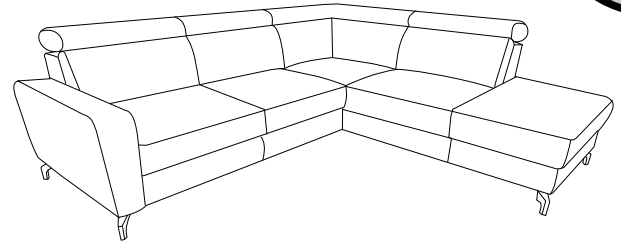
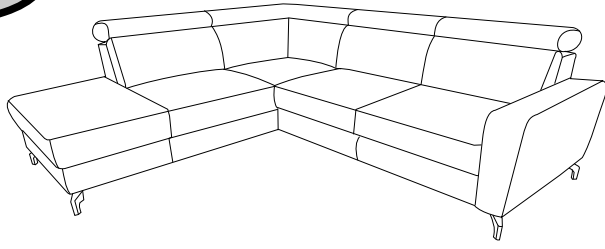

Typ · Type · Tip · Тип · Tipo · Típus



**L**

**R**



|   |   |   |  |   |
|---|---|---|--|---|
| <b>f</b> H- 120<br> | <b>g</b> H- 120<br> | <b>s</b> H- 120<br> | <b>q</b> M6*25<br> | <b>i</b> L- 4 [mm]<br> |
|                     |                     |                     |                    |                        |

