

A F36-MATCH2

58-7L2

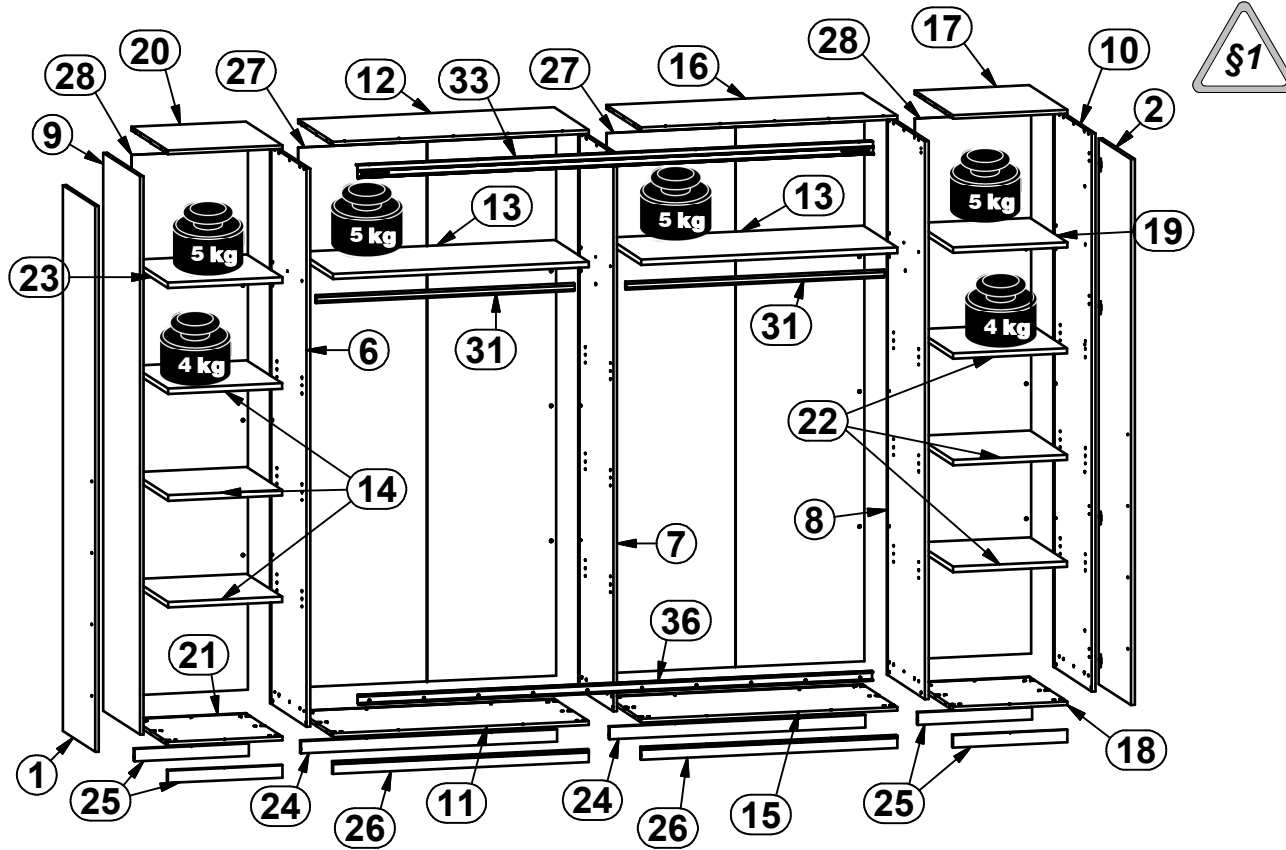

A	B	C (mm)		D
1	F36-001	2200	496	6/8
2	F36-002	2200	496	6/8
3	F36-003 A	1075	550	7/8
4	F36-004	1075	550	8/8
5	F36-005 A	1075	550	7/8
6	F36-101 B	2250	560	1/8
7	F36-102 A	2249	535	3/8
8	F36-103 B	2250	588	2/8
9	F36-104	2250	560	1/8
10	F36-105	2250	588	2/8
11	F36-301	1052	535	4/8
12	F36-302 A	1052	535	4/8
13	F36-303	1052	519	4/8
14	F36-305	469	543	3/8
15	F36-306	1052	535	4/8
16	F36-307 A	1052	535	1/8
17	F36-309	470	588	2/8
18	F36-310	470	588	2/8
19	F36-311	470	572	3/8
20	F36-321	470	560	1/8
21	F36-322	470	560	1/8
22	F36-323	469	571	3/8
23	F36-324	470	544	3/8
24	F36-401	1052	50	2/8
25	F36-402	470	50	2/8
26	F36-403 A	1052	50	2/8
27	F36-901	2177	1059	2/8
28	F36-902	2178	478	1/8
30	c410/2	900	10	2/8
31	dr-1046	1046	22	2/8
32	EG-sp 2200	2200	4	5/8
33	w249/6	2118	51	5/8
34	w136/3	2200	37	5/8
35	w136/2	2200	17	5/8
36	w250/5	2114	32	5/8

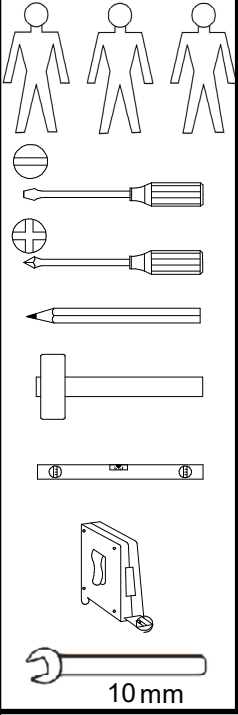
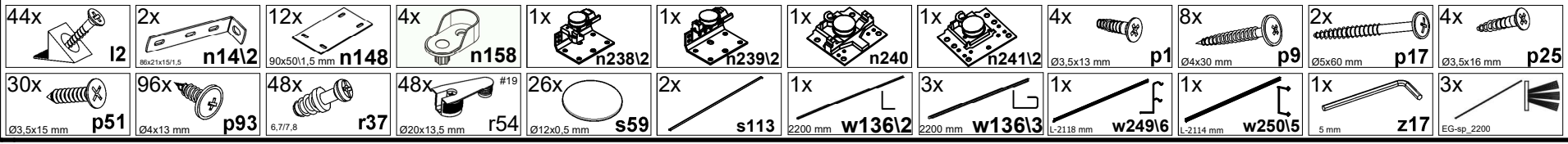
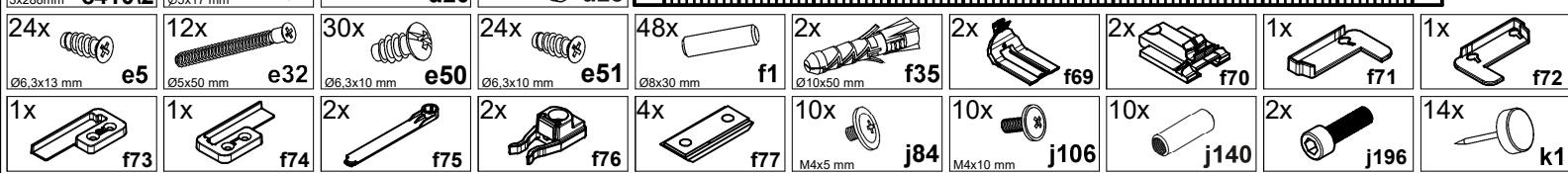
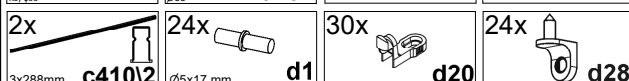
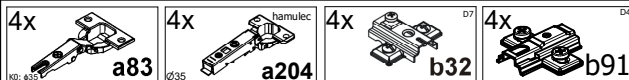

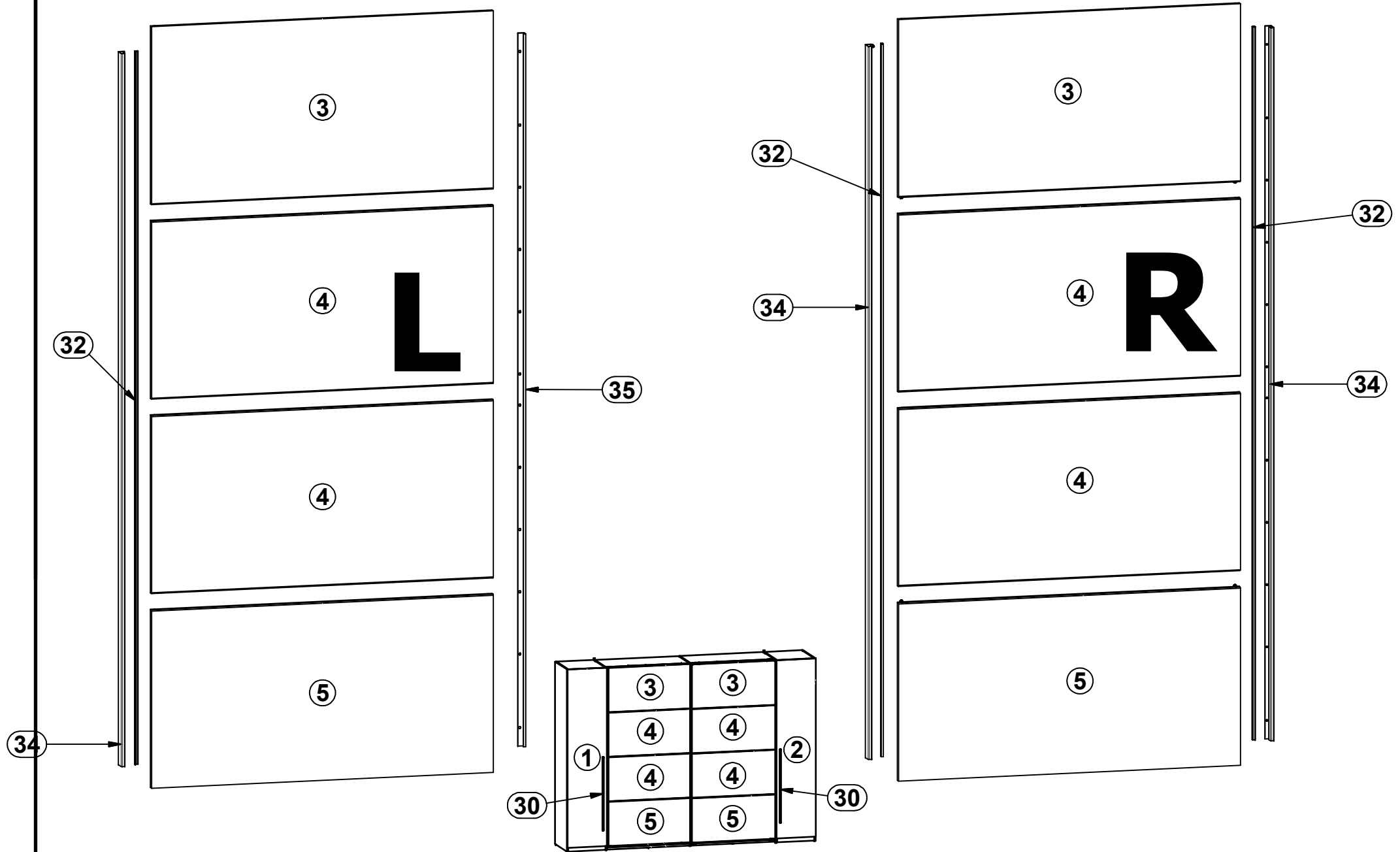



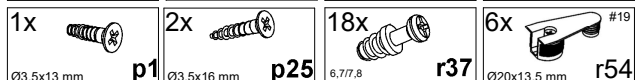
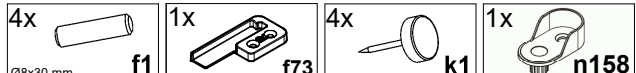
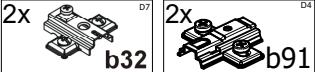
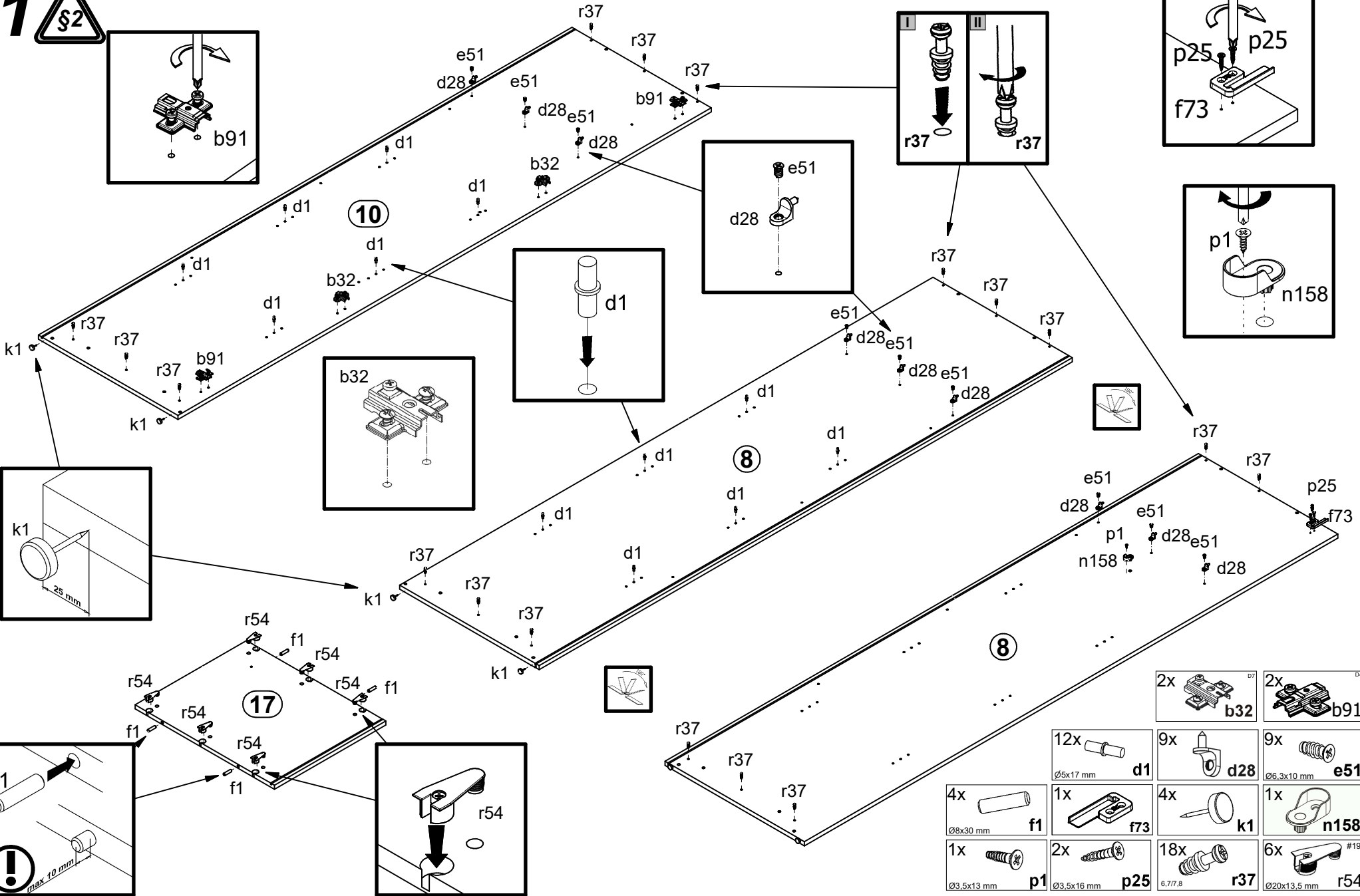
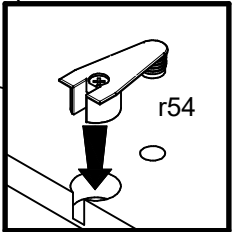
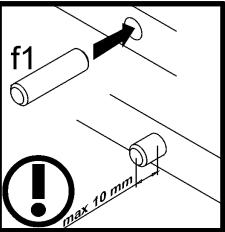
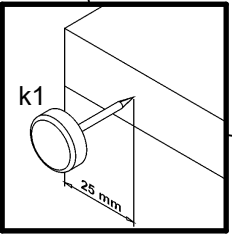
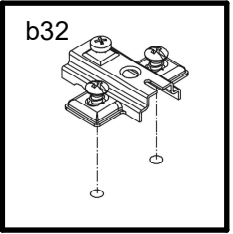
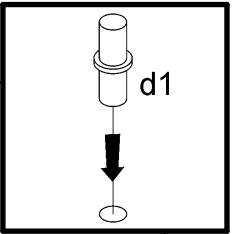
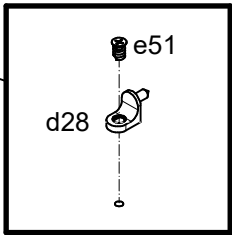
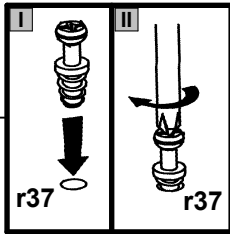
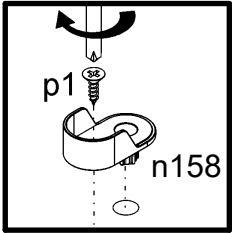
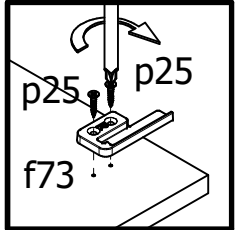
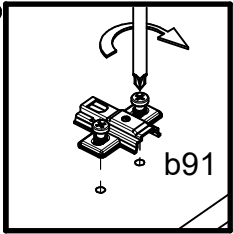



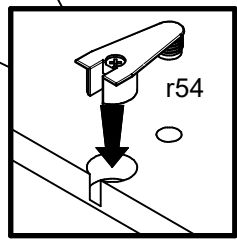
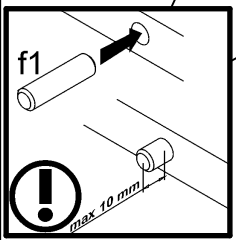
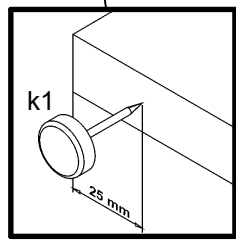
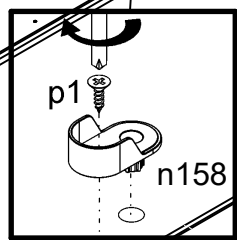
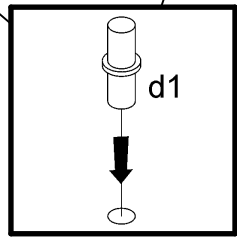
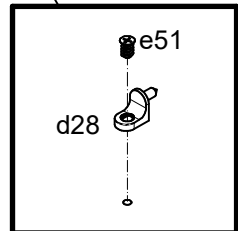
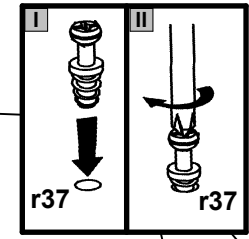
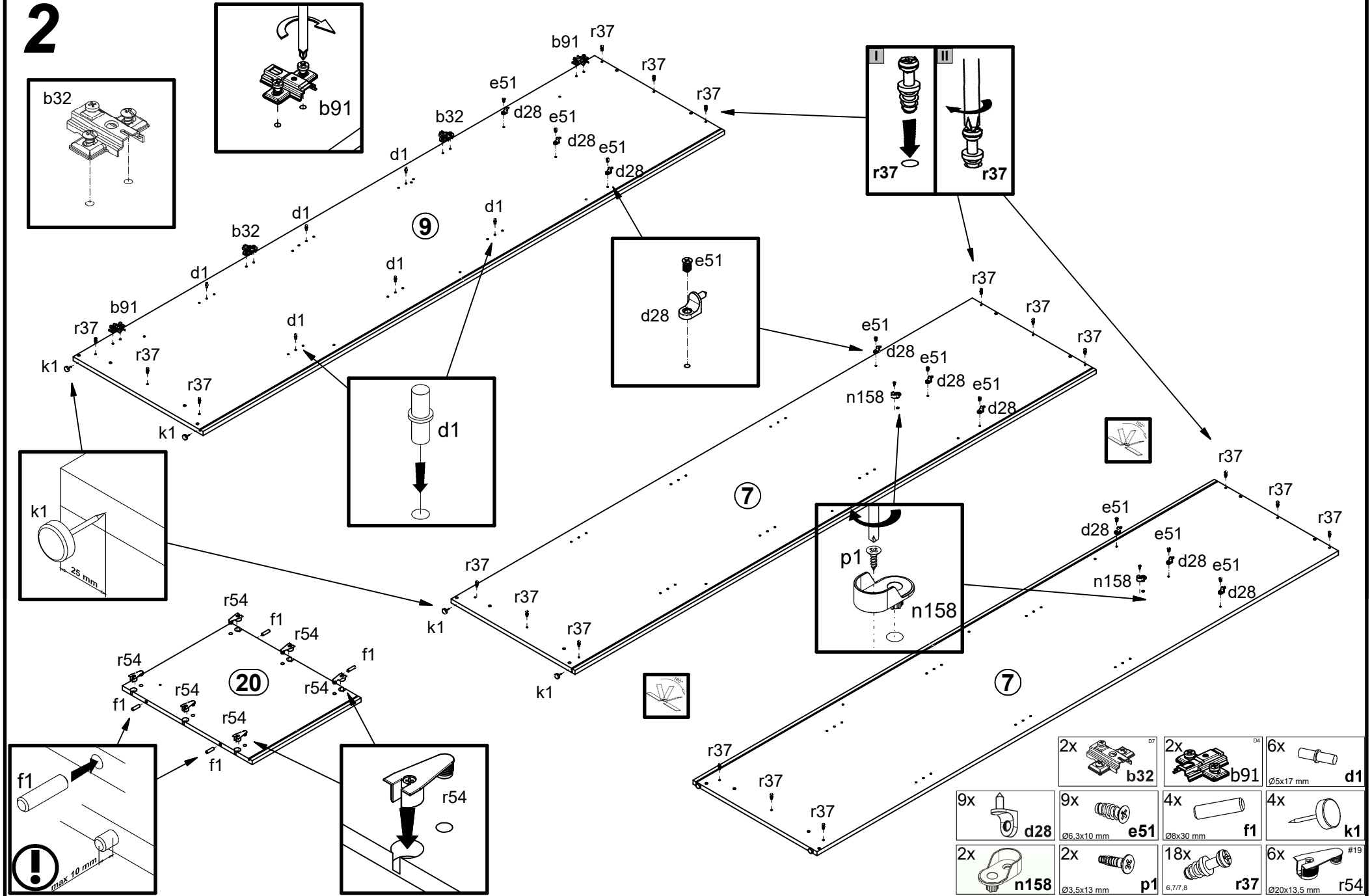

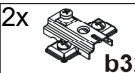
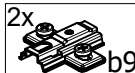

1



2



2x  b32	2x  b91	6x  d1 Ø5x17 mm
9x  d28	9x  e51 Ø6.3x10 mm	4x  f1 Ø8x30 mm
2x  n158	2x  p1 Ø3.5x13 mm	18x  r37 6.7/7.8
		4x  k1
		6x  r54 #19 Ø20x13.5 mm

3

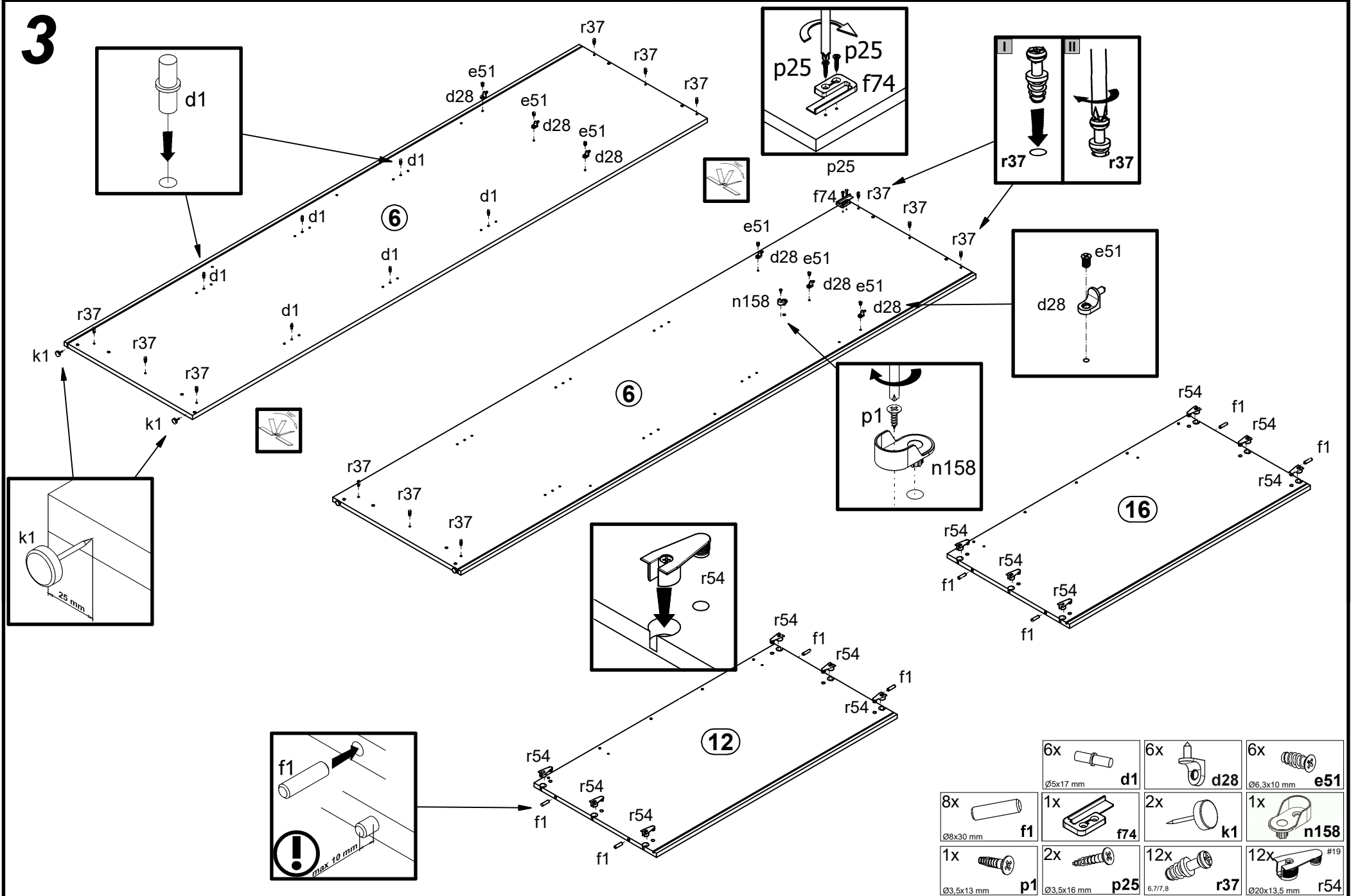



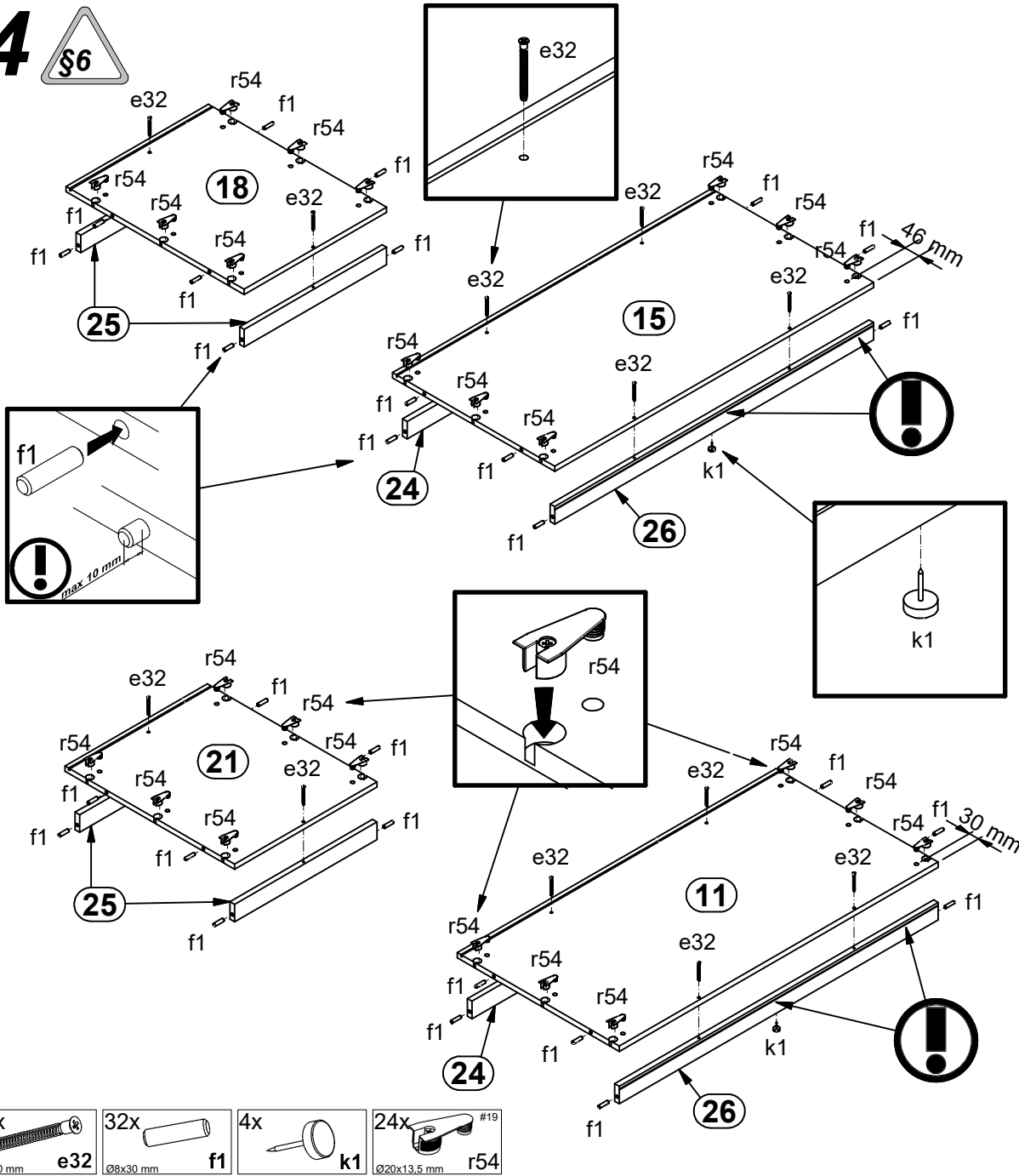

6x Ø5x17 mm d1	6x d28	6x Ø6.3x10 mm e51
8x Ø8x30 mm f1	1x f74	2x k1
1x Ø3.5x13 mm p1	2x Ø3.5x16 mm p25	12x 6.7/7.8 r37
		12x Ø20x13.5 mm #19 r54

4 

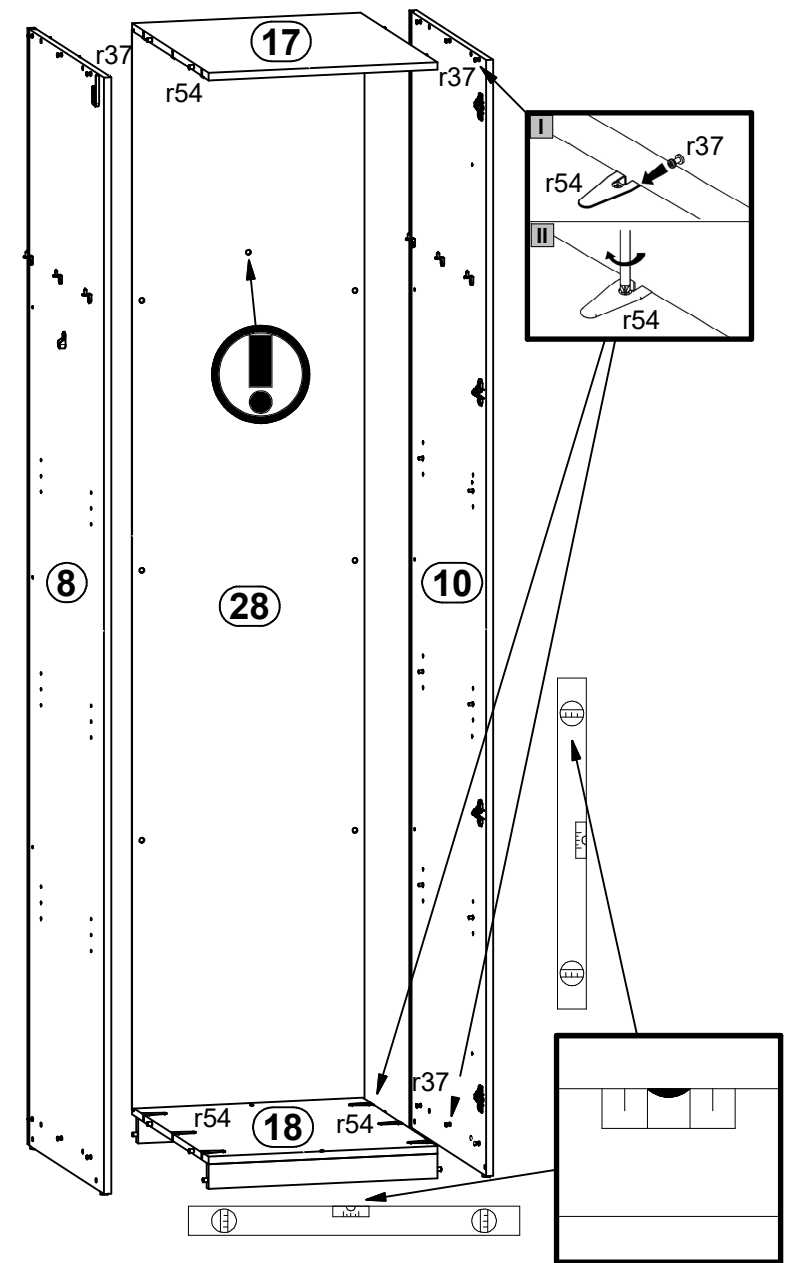

5

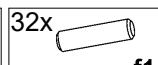

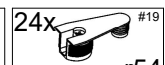
-  12x **e32** Ø5x50 mm
-  32x **f1** Ø8x30 mm
-  4x **k1**
-  24x **r54** #19 Ø20x13,5 mm

6

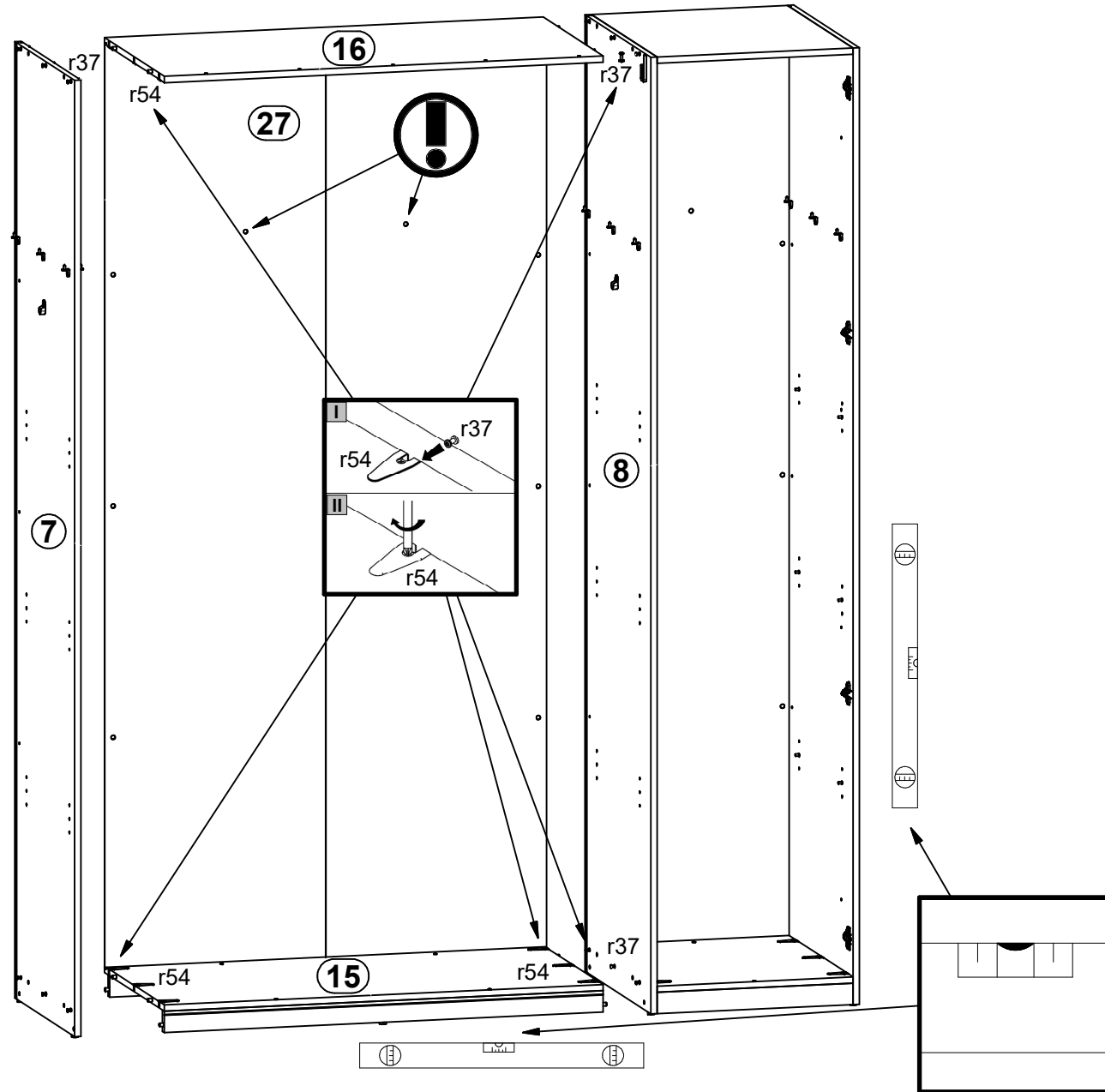

7

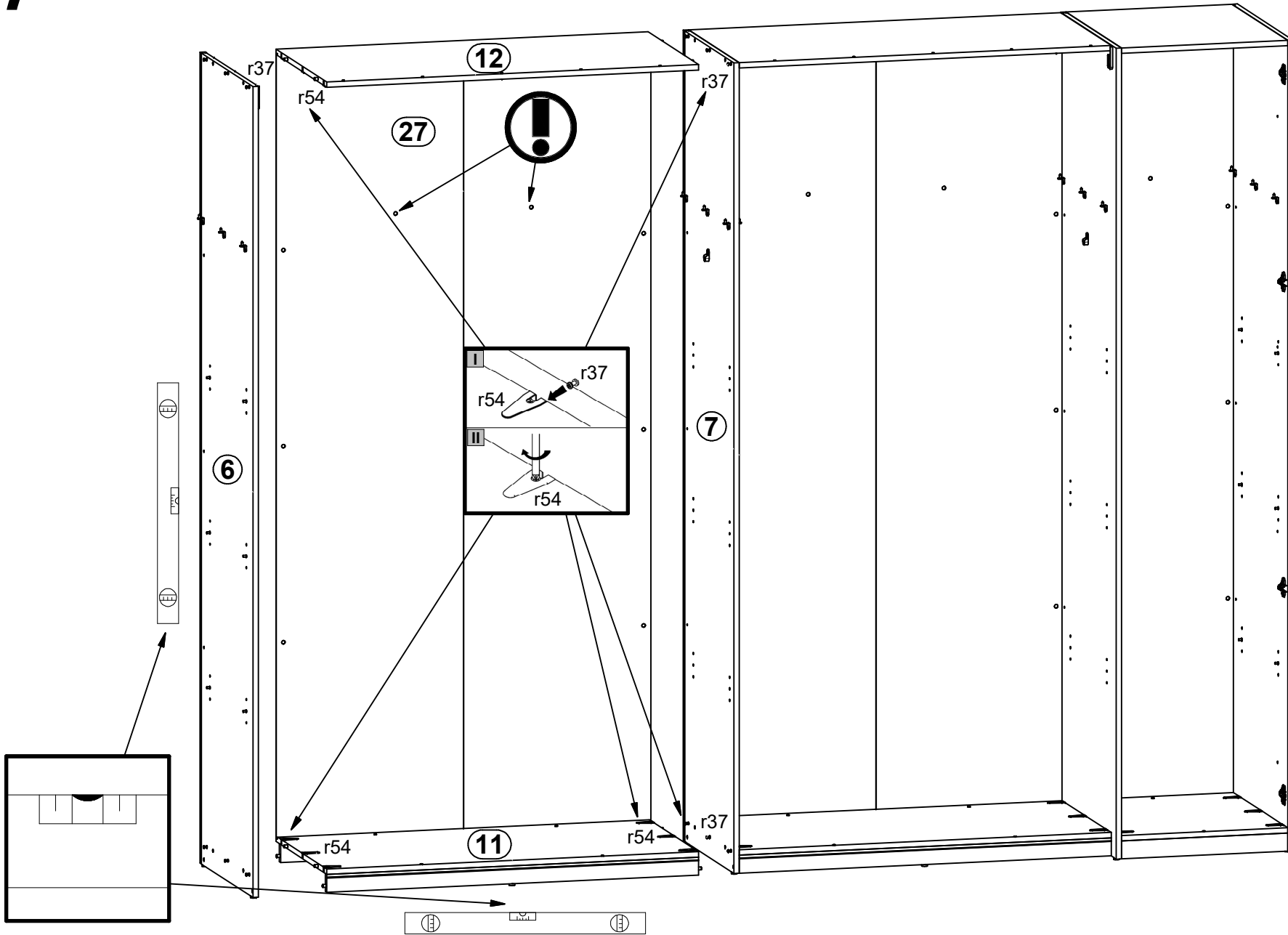

8

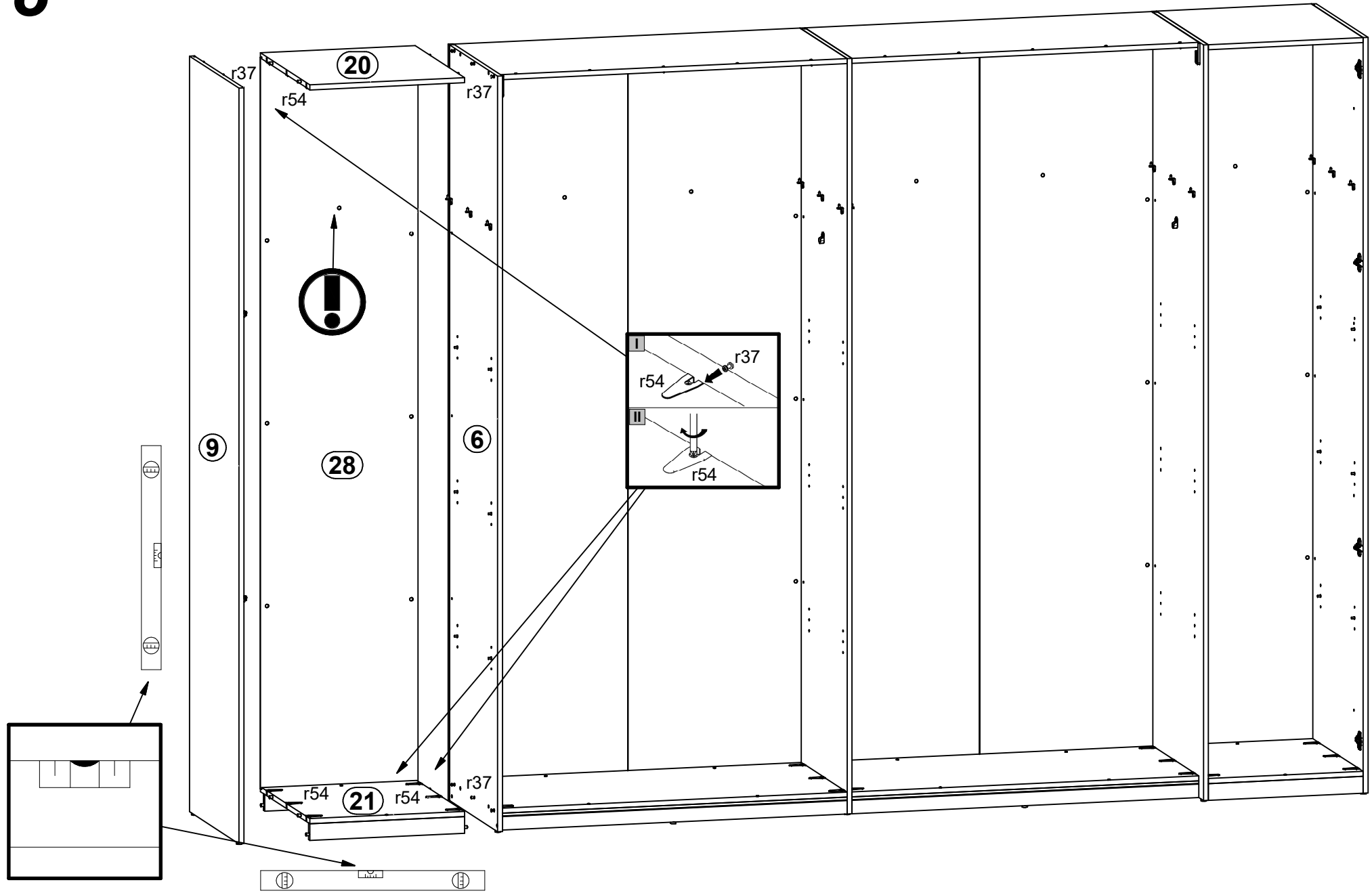

9

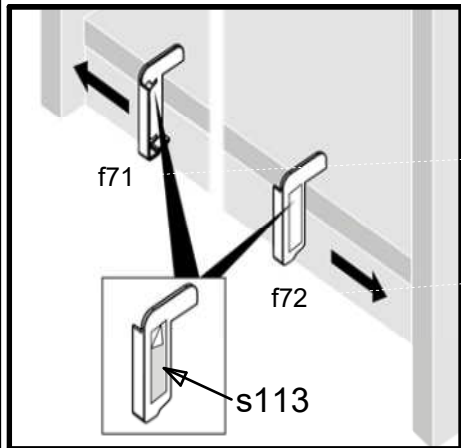
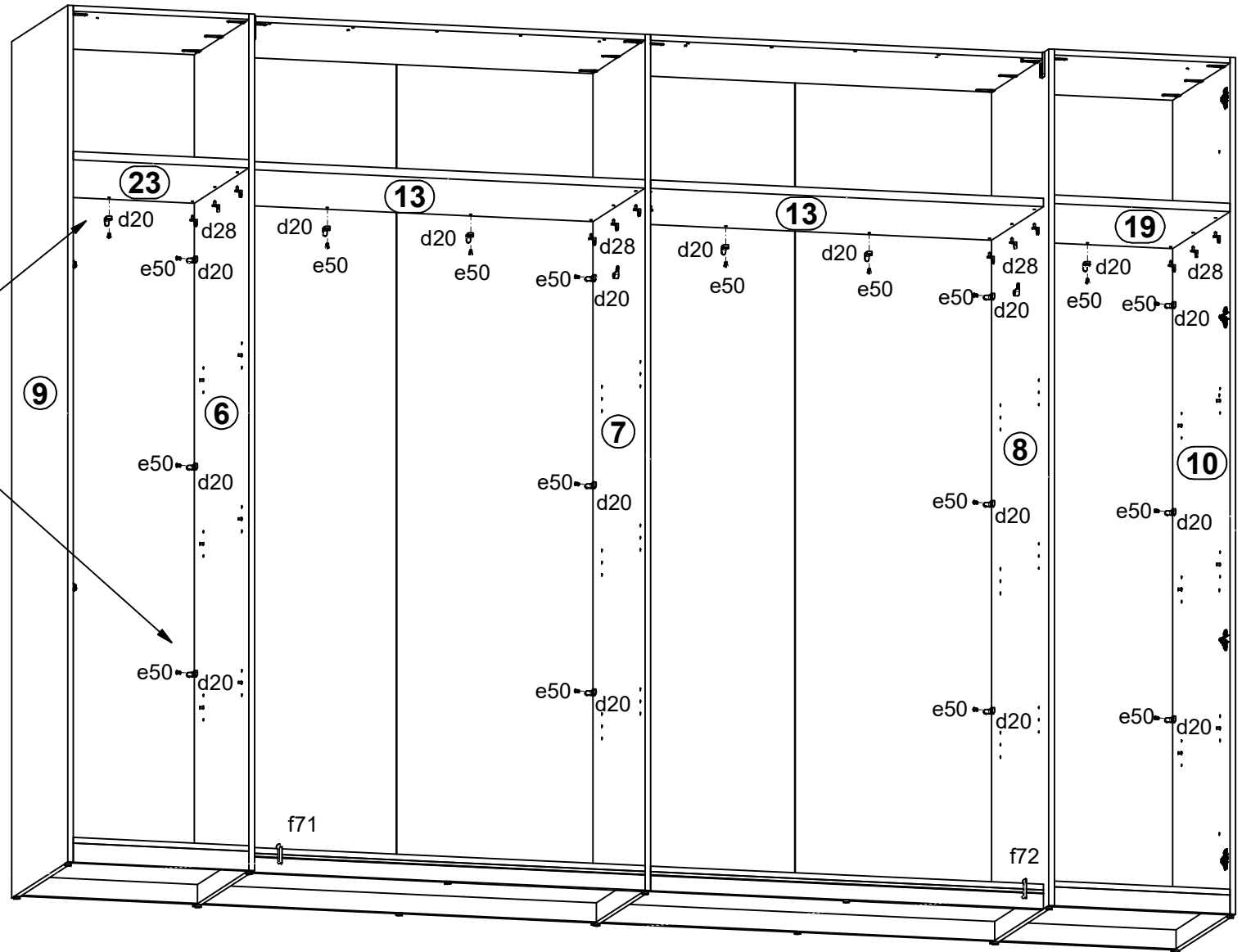
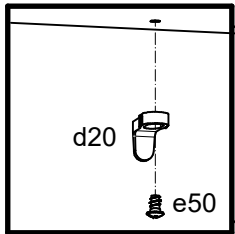
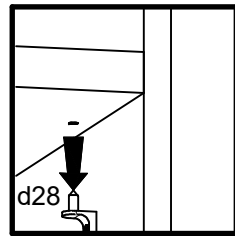

2x s113	1x f71	1x f72	30x Ø6,3x10 mm e50	30x d20
------------	-----------	-----------	--------------------------	------------

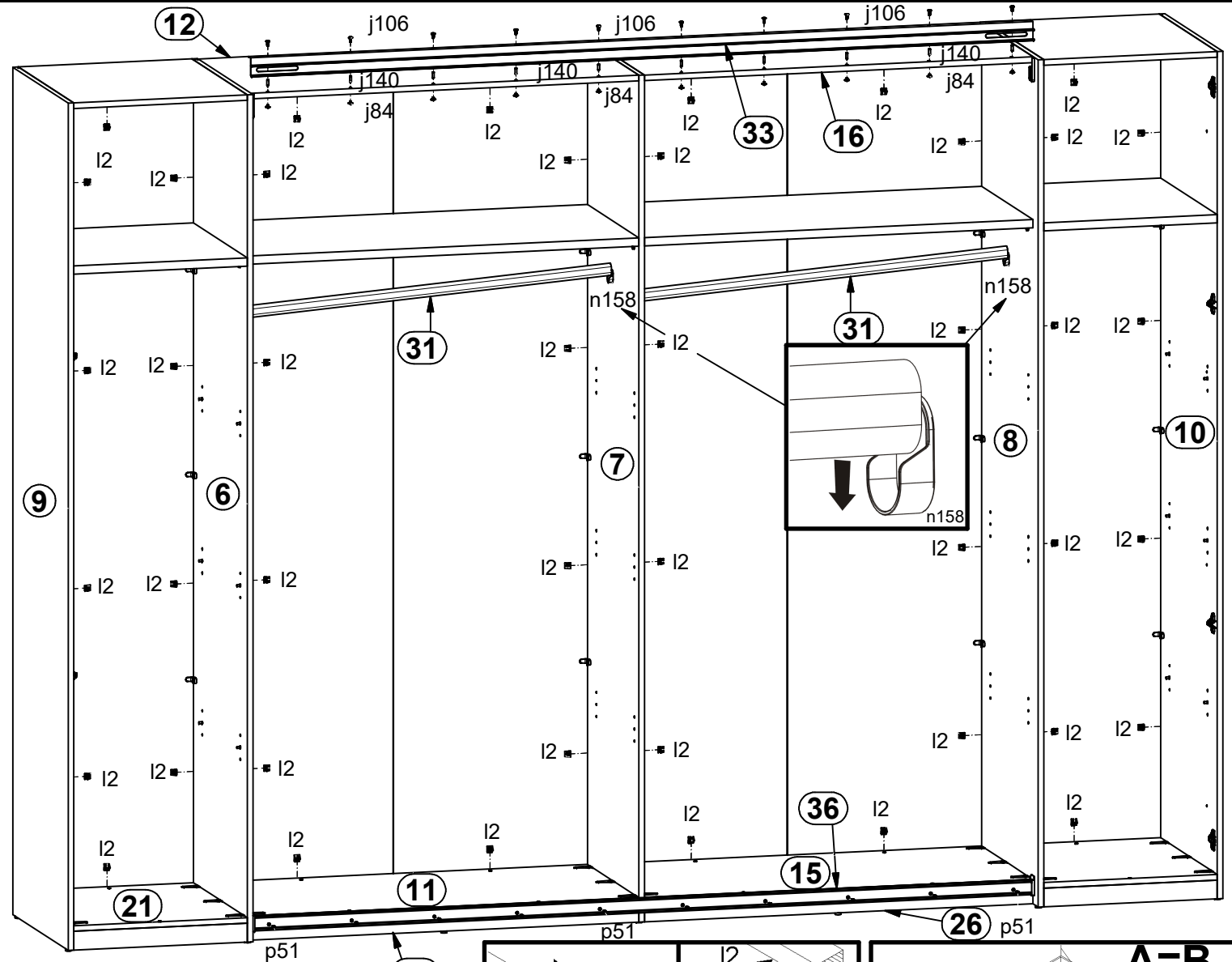
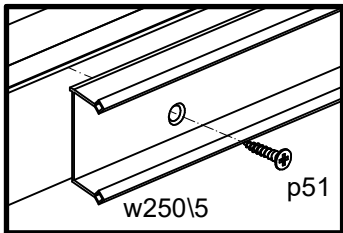
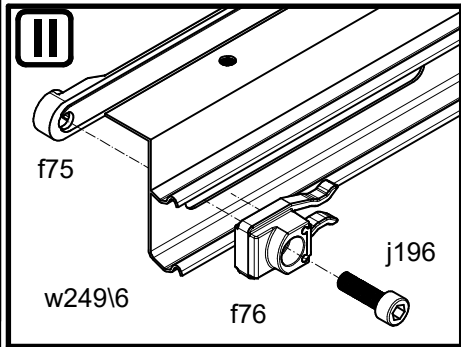
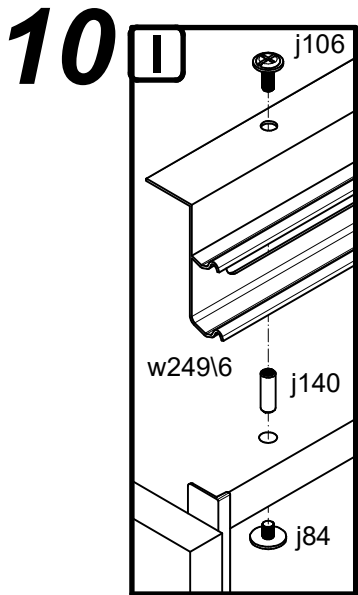

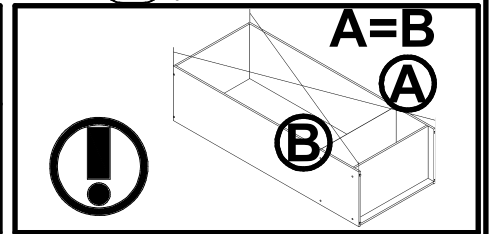
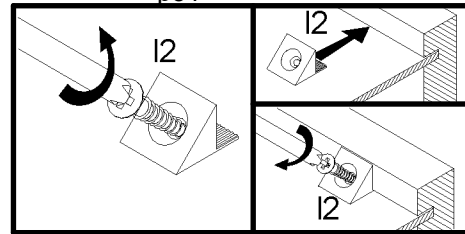

- | | | | | |
|------------|-----------------|-------------|---------------------------|--------------------------|
| 2x
f76 | 12x
M4x10 mm | 12x
j106 | 1x
j140
L=2114 mm | 1x
w250\5 |
| 2x
j196 | 12x
M4x5 mm | 44x
j84 | 1x
w249\6
L=2118 mm | 10x
p51
Ø3.5x15 mm |



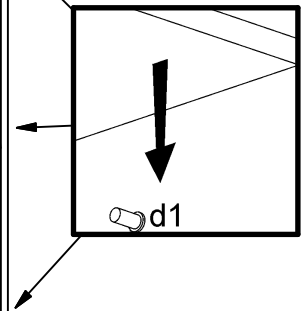
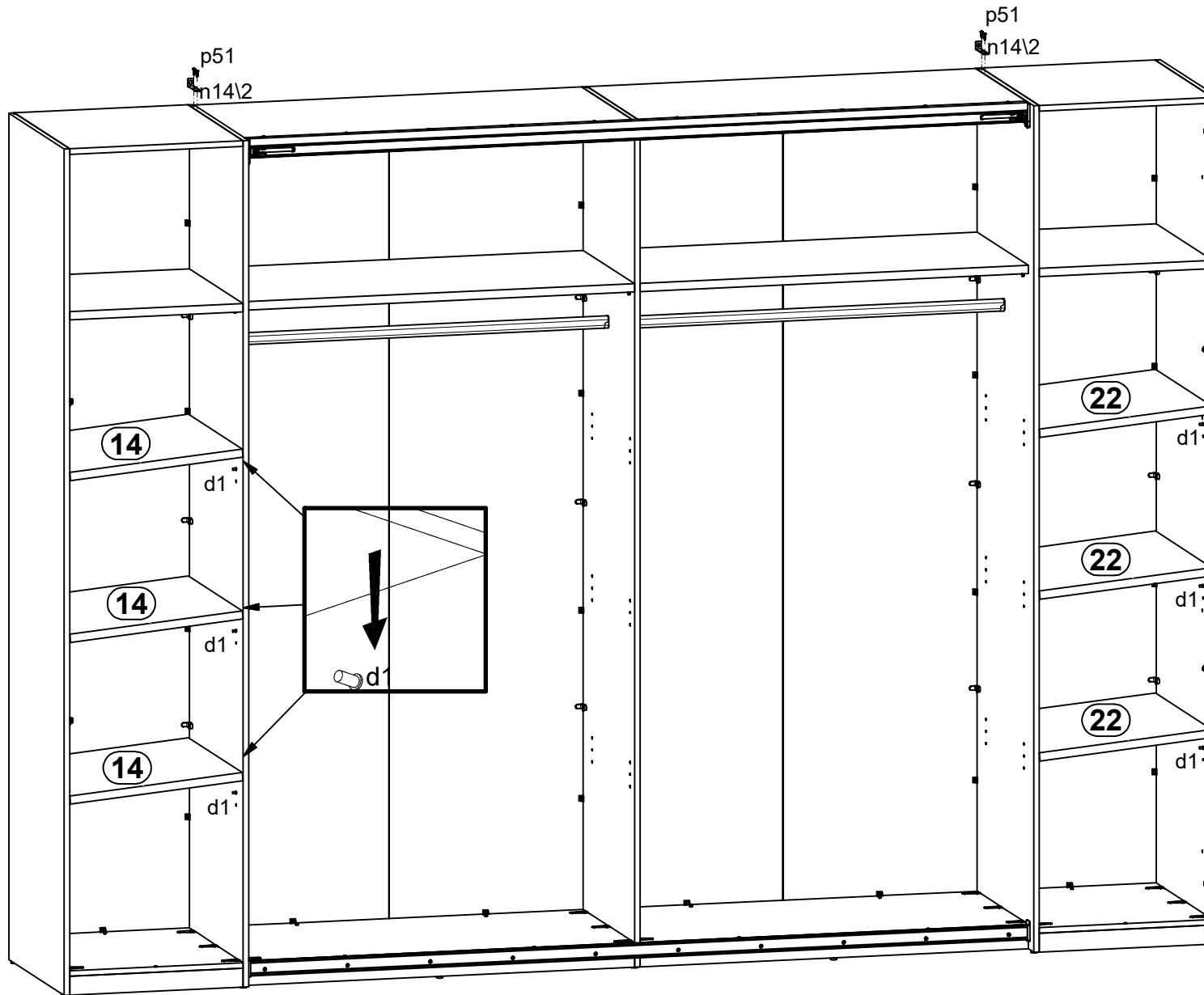
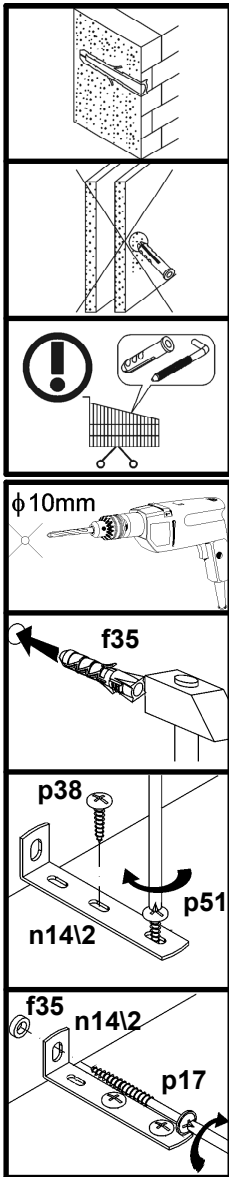

11

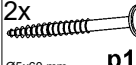
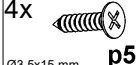

- 2x  **f35**
Ø10x50 mm
- 2x  **n14\2**
86x21x15/1.5
- 2x  **p17**
Ø5x60 mm
- 4x  **p51**
Ø3.5x15 mm

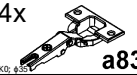
12

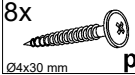
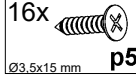
- 4x  a83
- 4x  a204
- 2x  c410/2
- 8x  p9
- 16x  p51

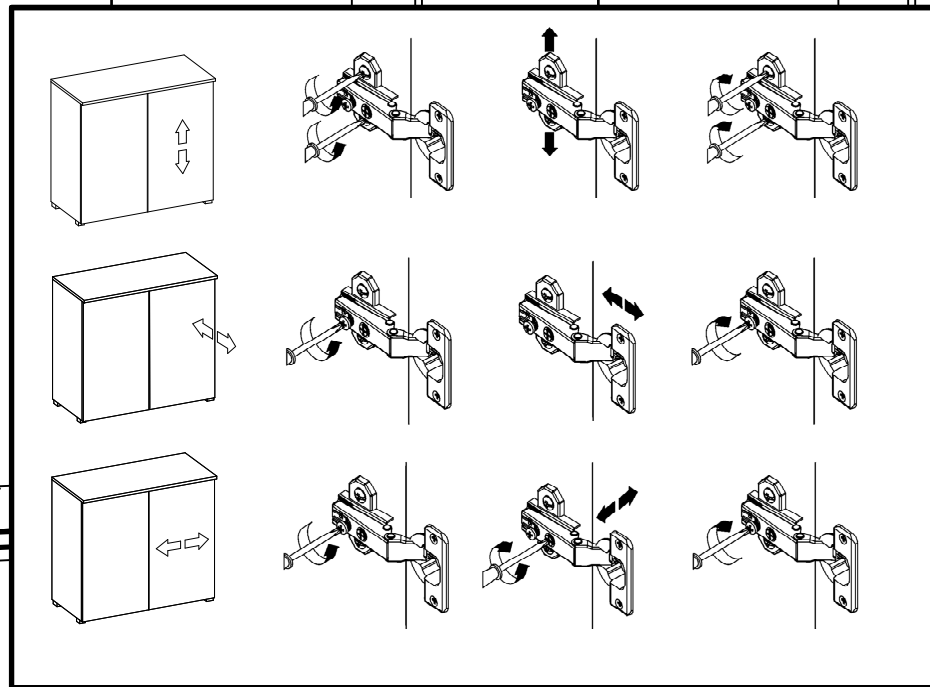
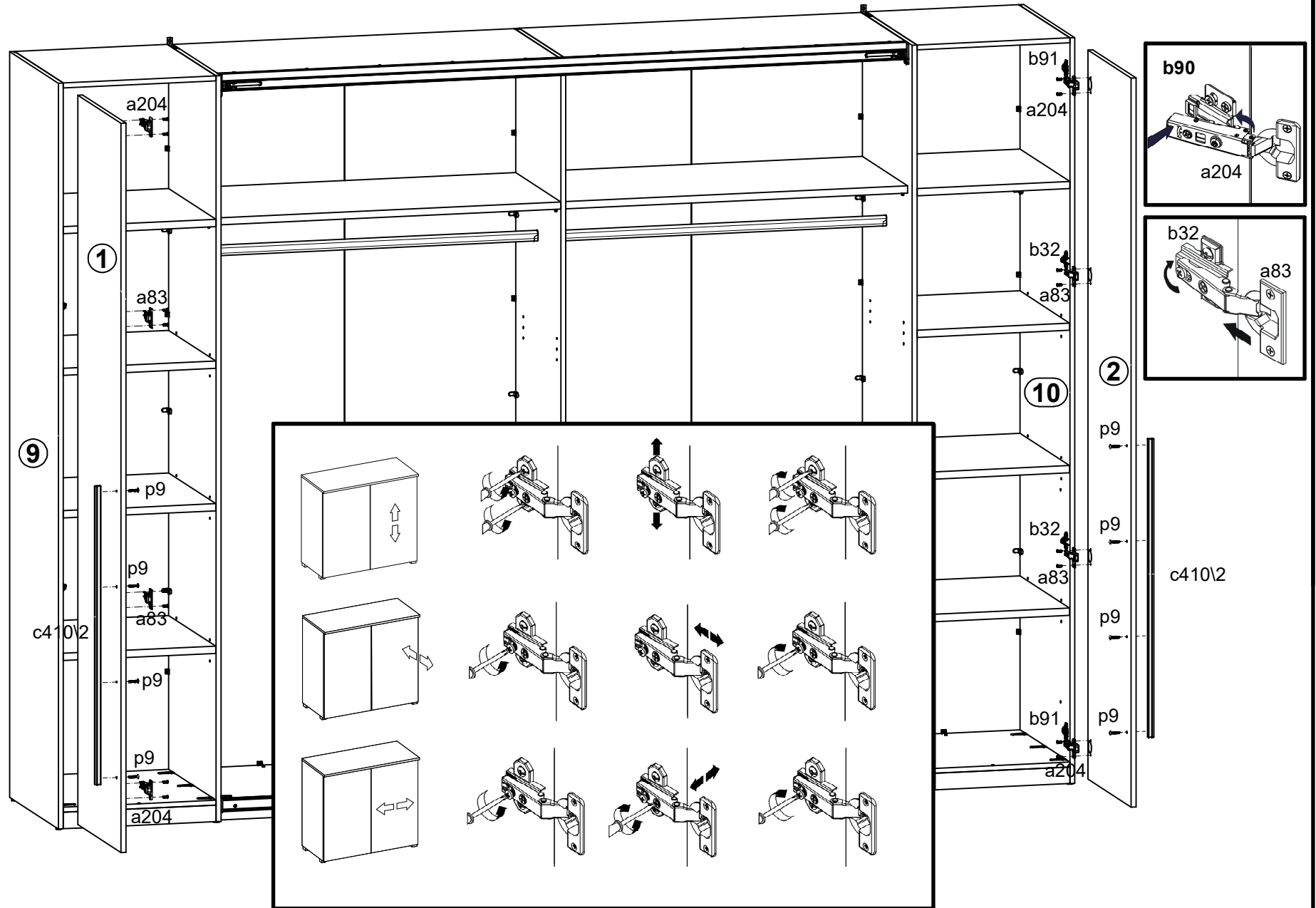
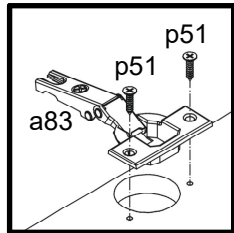
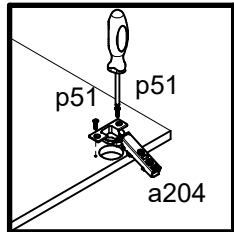

13

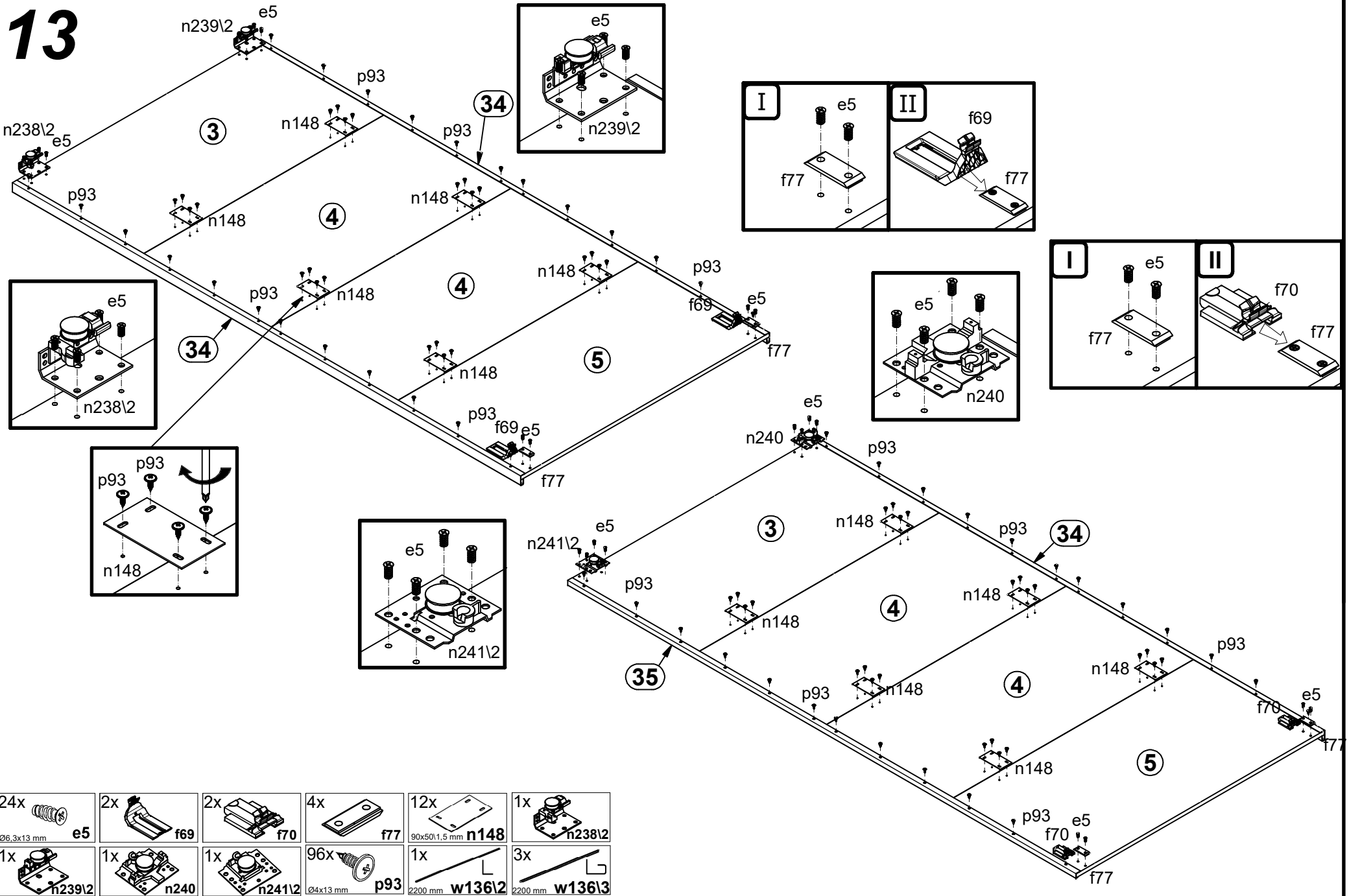

24x Ø6,3x13 mm e5	2x f69	2x f70	4x f77	12x 90x50x1,5 mm n148	1x n238\2
1x n239\2	1x n240	1x n241\2	96x Ø4x13 mm p93	1x 2200 mm w136\2	3x 2200 mm w136\3

14

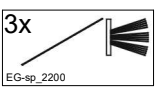
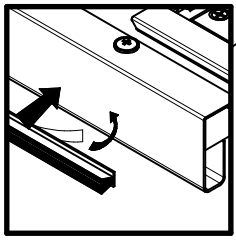
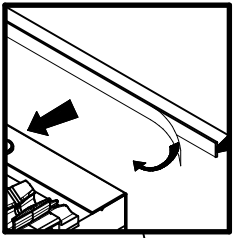
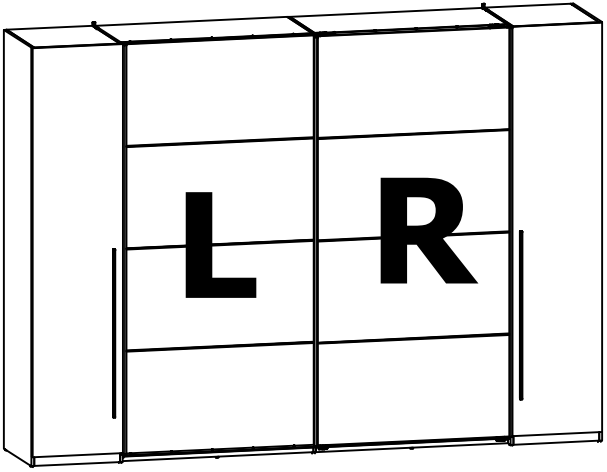
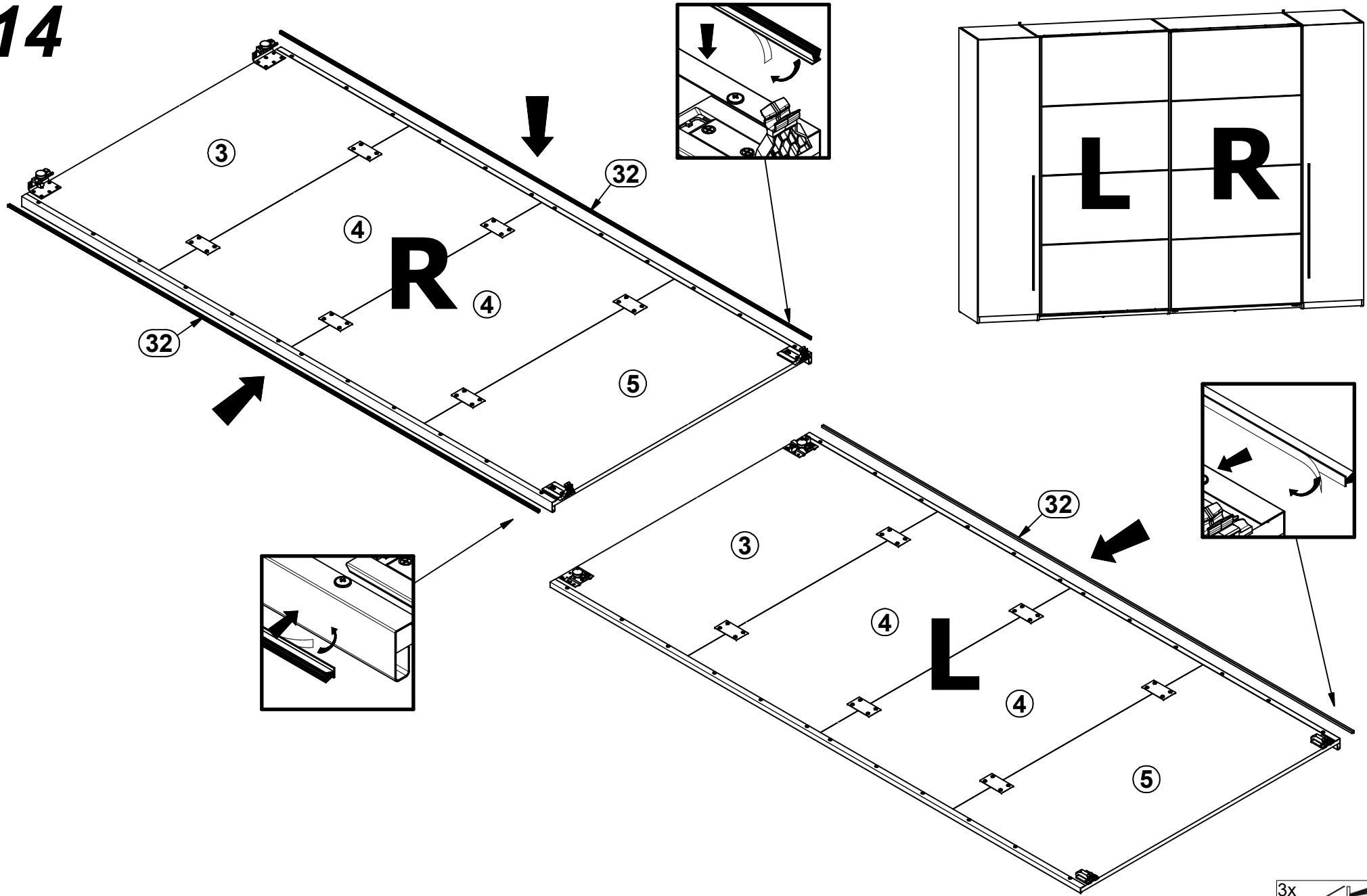

15

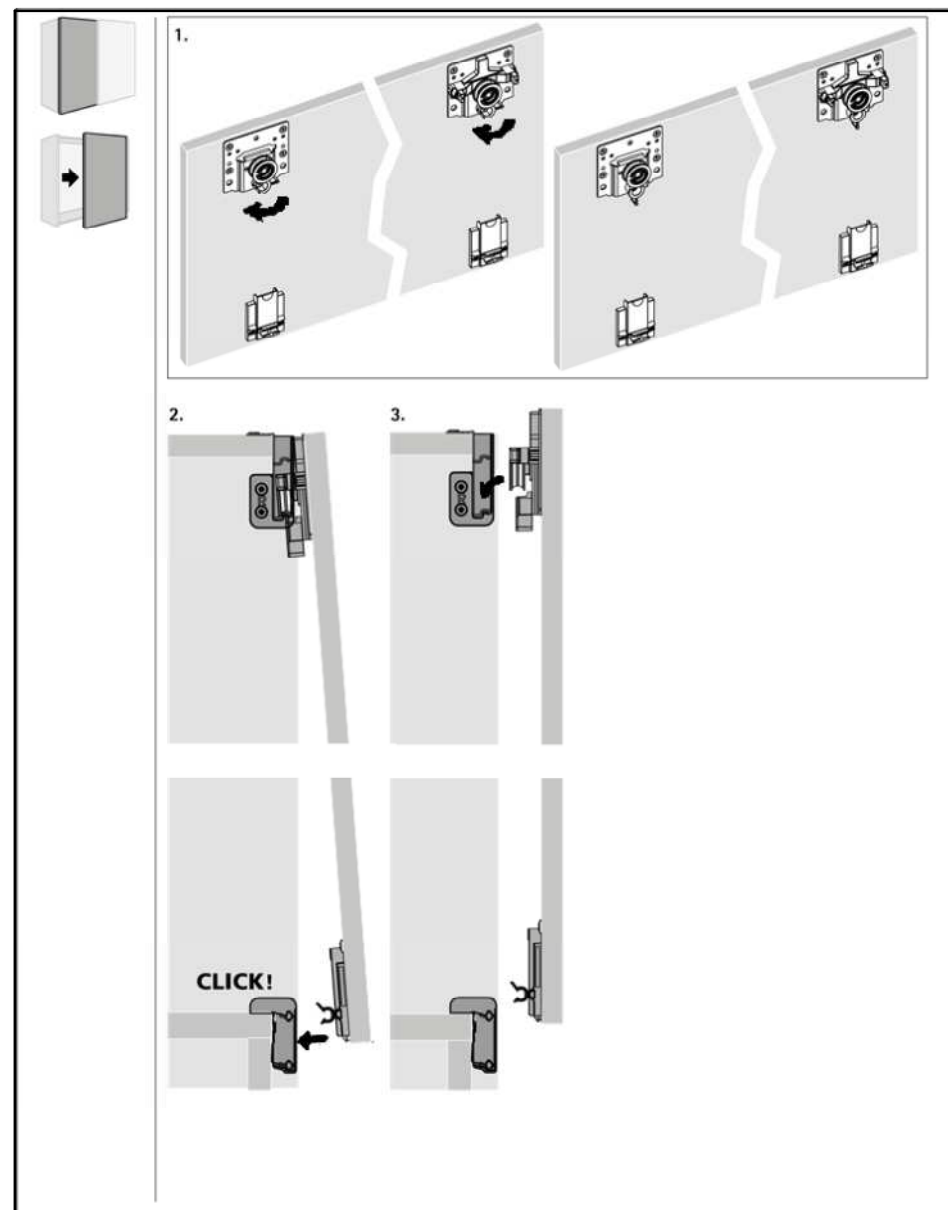
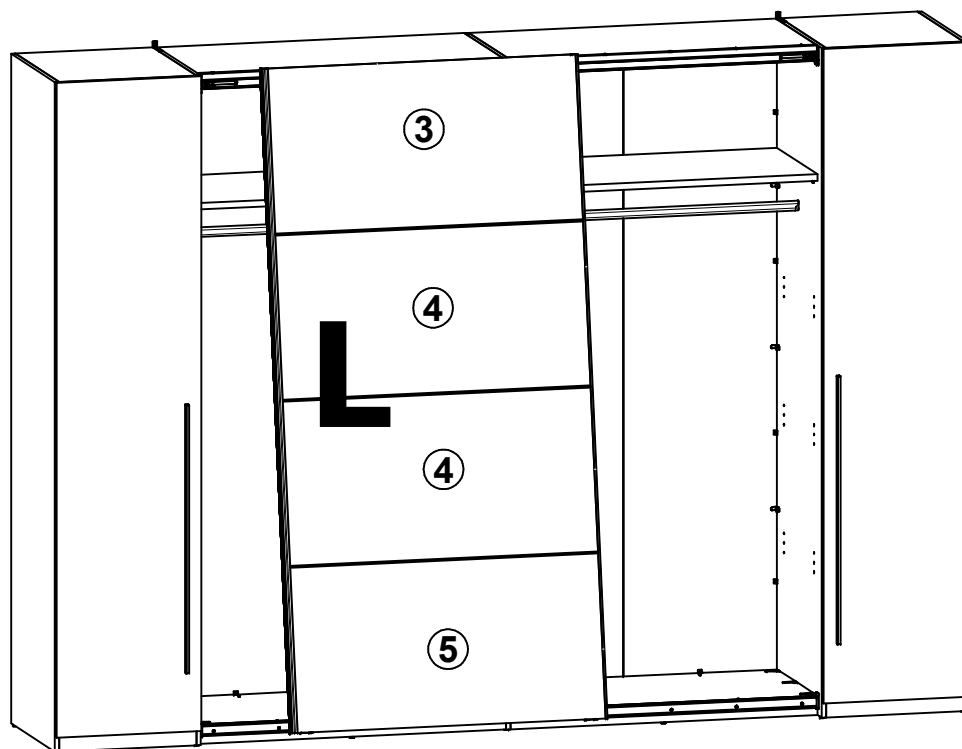

16

