

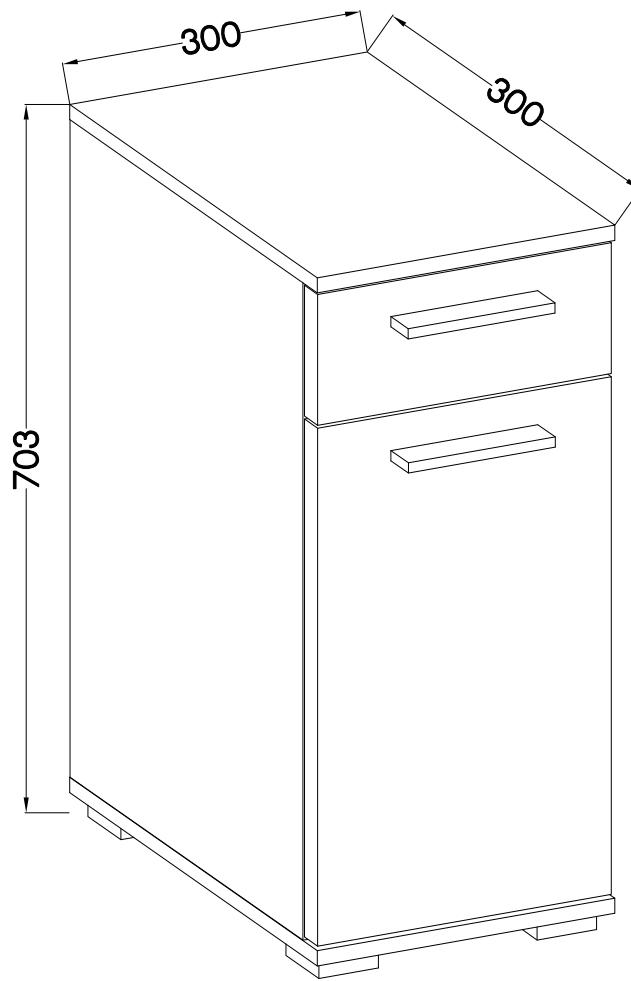

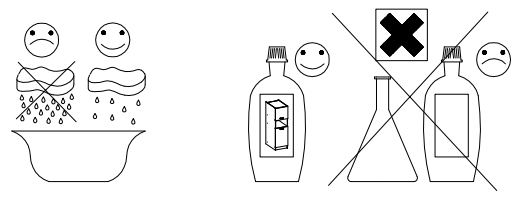

















36-314-..



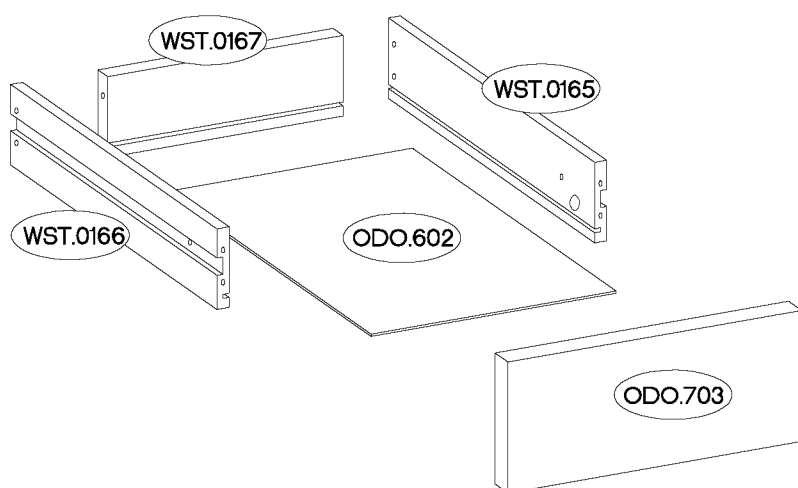
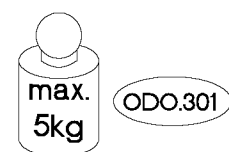
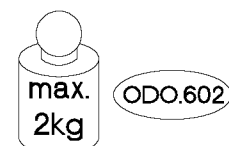
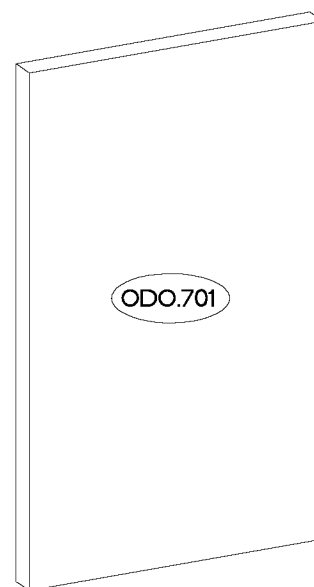
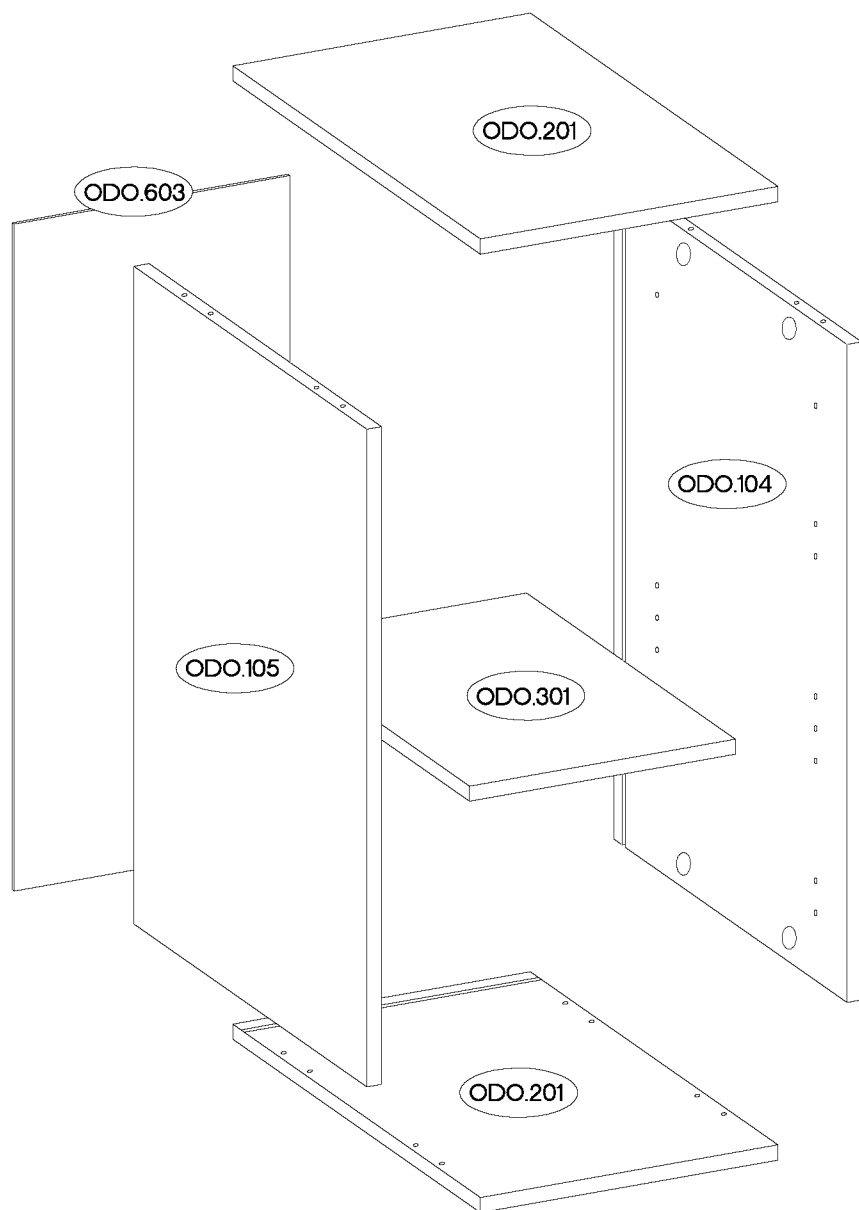

 A 12		 B2 2		 C 8		 C5 2		 D2 10		 E 2		 F1 4		 HG 2							
 I 1		 J3 4		 L 4		 L9 1		 M 4		 O7 1		 P2 8		 P5 5		 R1 4		 S 2		 U1 2	

ISM-ODO-03



Colli	Ersatzteil Nummer	Dimension
Colli 1/1	ODO.104	653x282x15
	ODO.105	653x282x15
	ODO.201 x2	300x300x15
	ODO.301	268x253x15
	ODO.602	247x247x2.5
	ODO.603	662x278x2.5
	ODO.701	514x296x16
	ODO.703	130x296x16
	WST.0165	250x80x12
	WST.0166	250x80x12
	WST.0167	237x80x12

1

±12/10mm  C5 2	±8x30mm  A 4
---	---

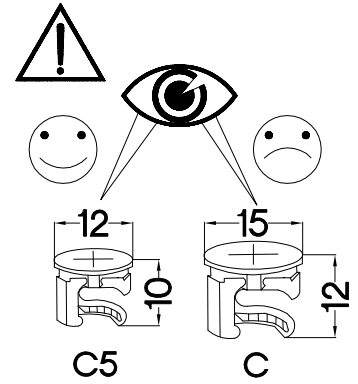
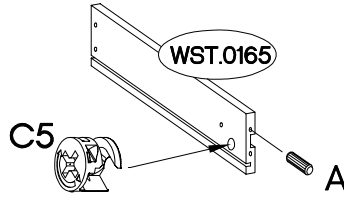
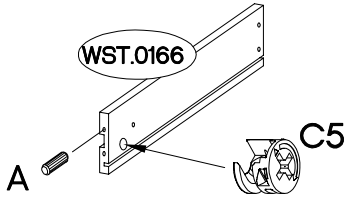
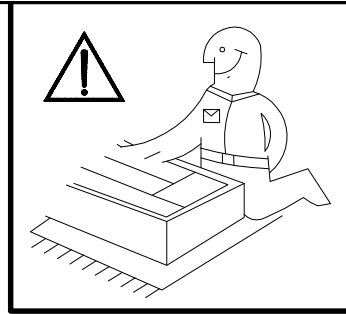

2

±6x42mm  B2 2

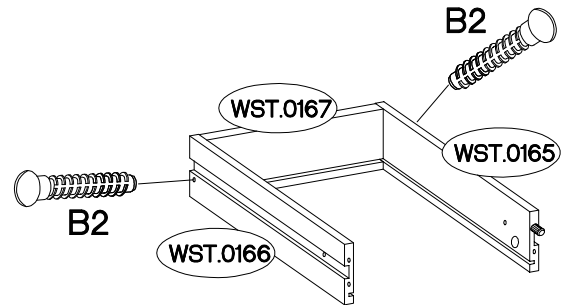
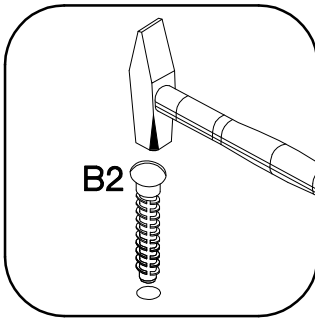
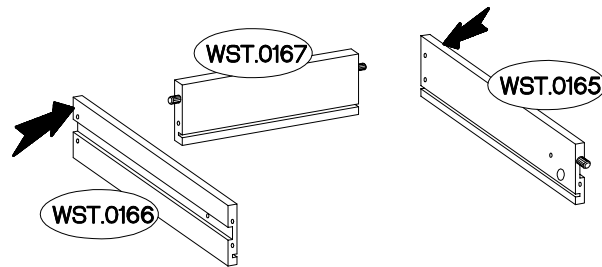



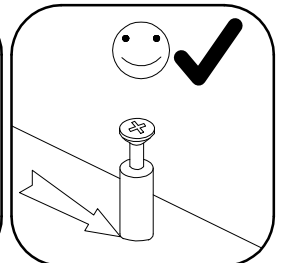
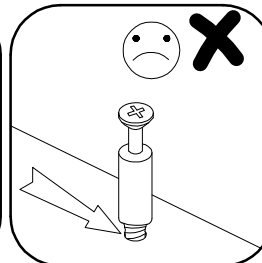
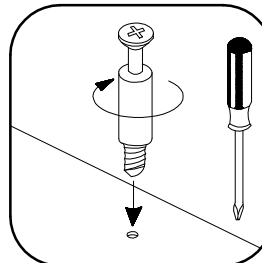
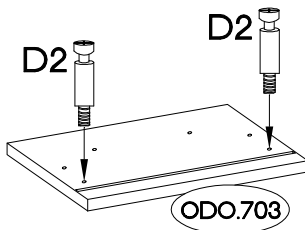
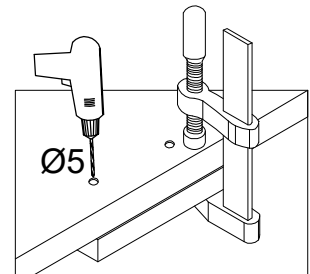
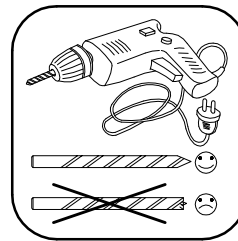
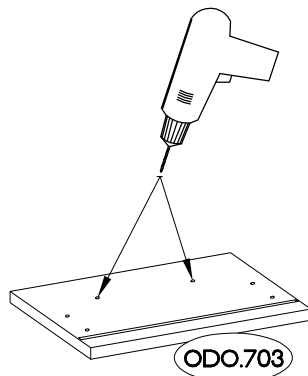

3

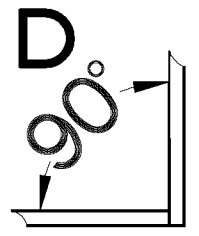
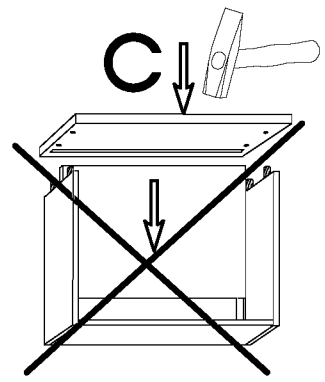
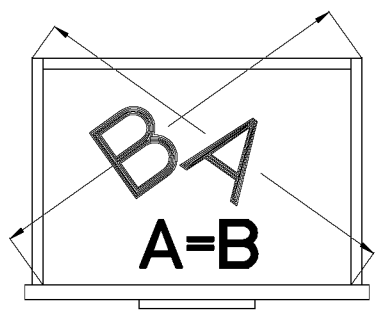
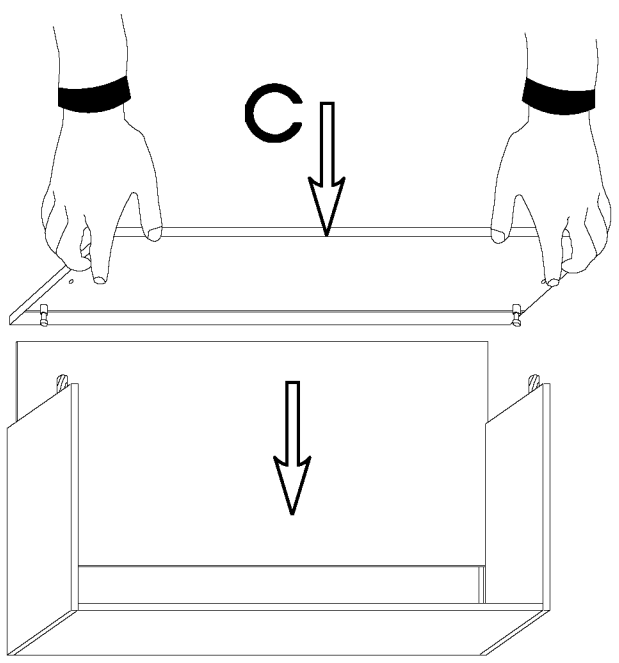
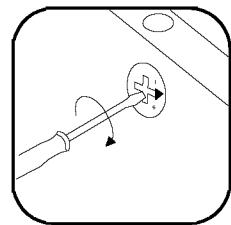
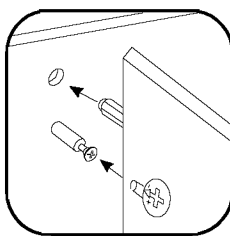
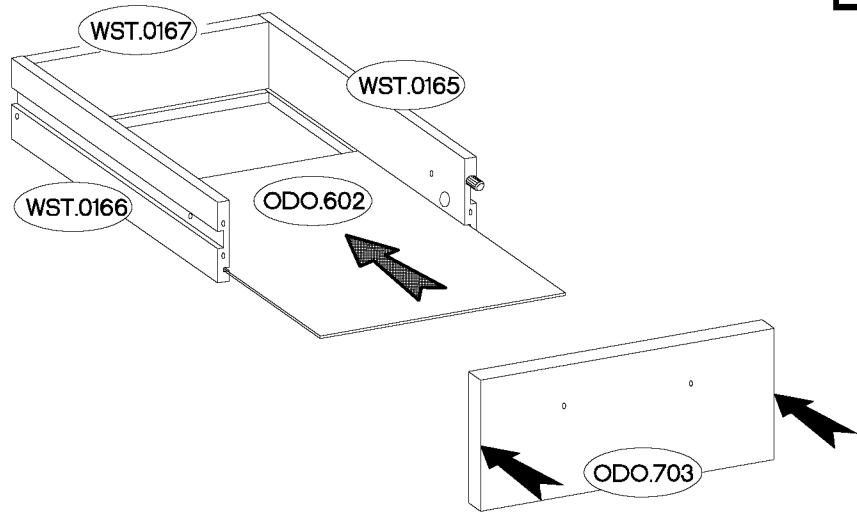
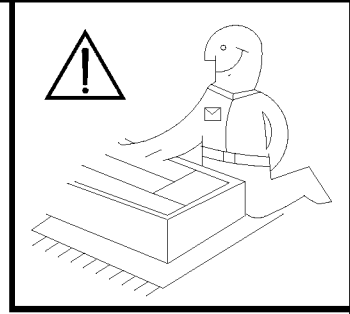

L=20mm  D2 2
--

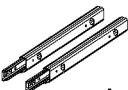

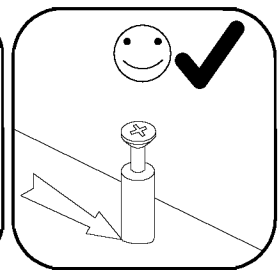
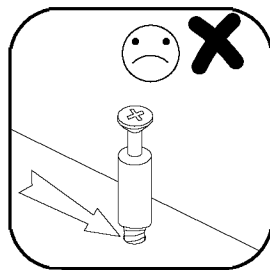
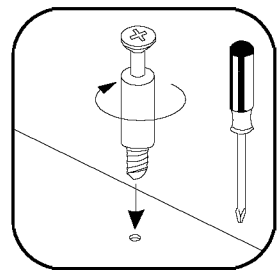
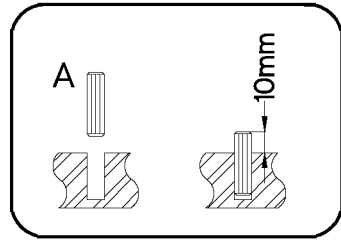
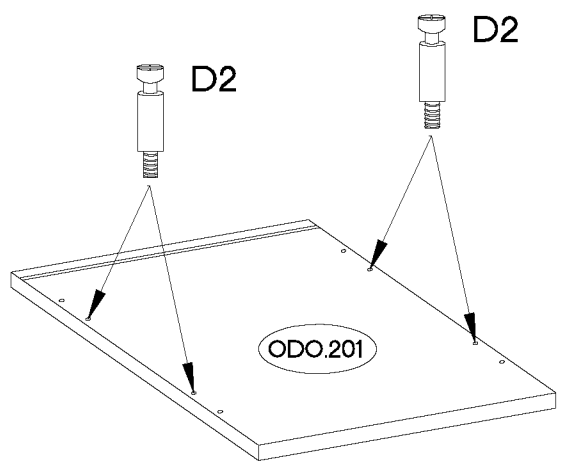
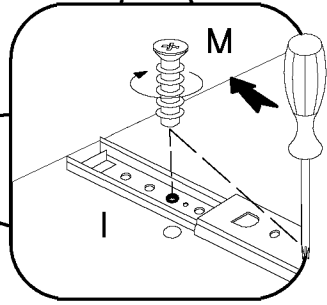
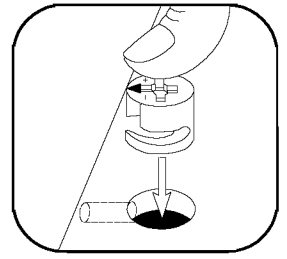
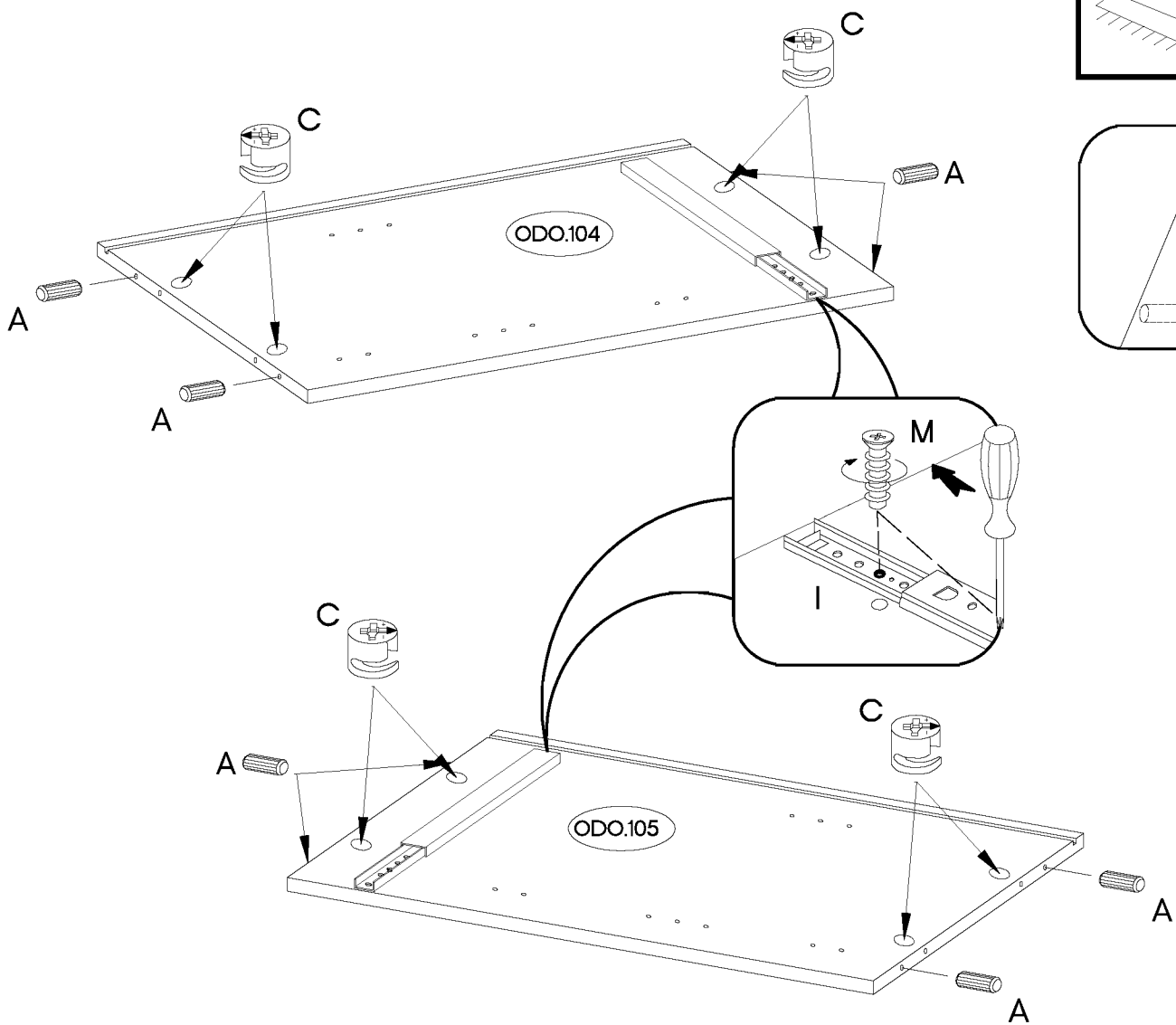
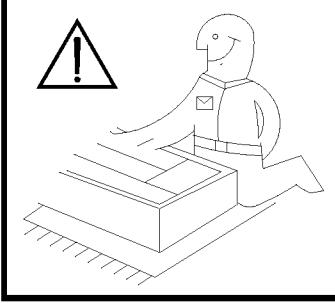

$\varnothing 8 \times 30 \text{mm}$  A 8	$\varnothing 15/12 \text{mm}$  C 8	$L=20 \text{mm}$  D2 4	$17/246 \text{mm}$  I 1	$\varnothing 5.0 \times 13 \text{mm}$  M 4
--	--	--	---	--



L=20mm  D2 4	60x40x20  F1 4	4.0x20mm  P2 8
---	---	---

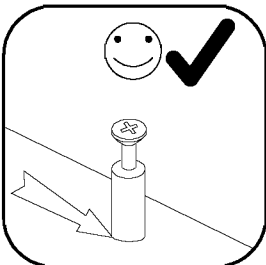
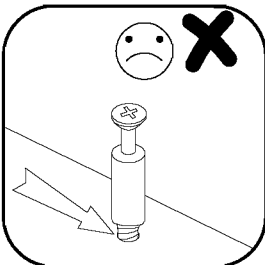
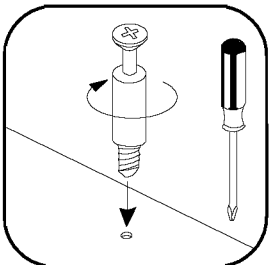
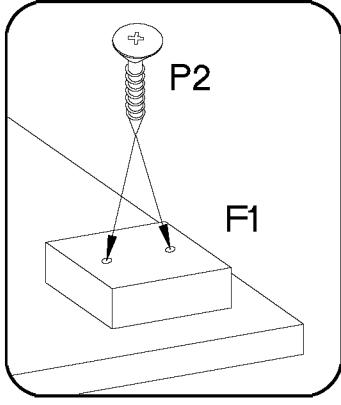
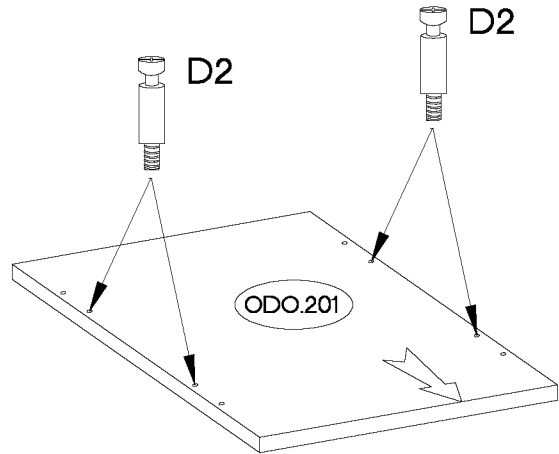
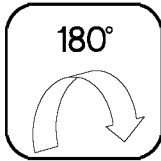
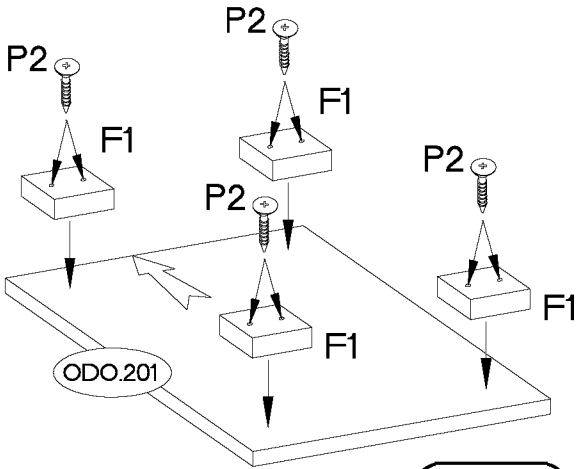
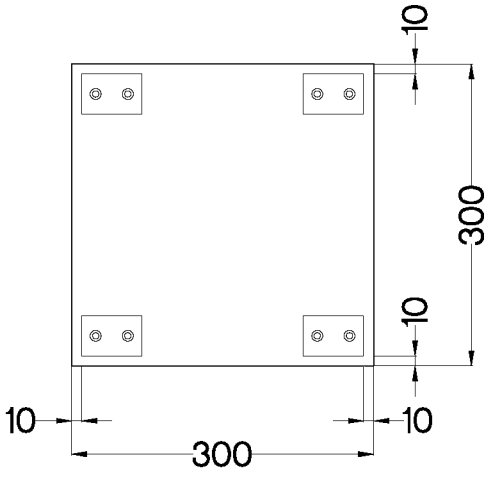
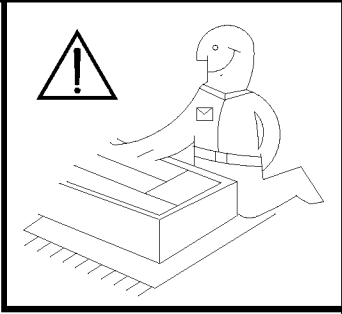

7

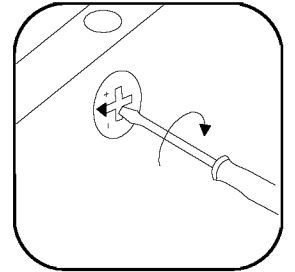
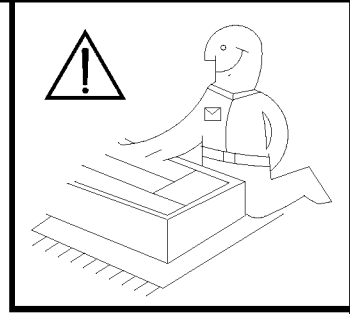
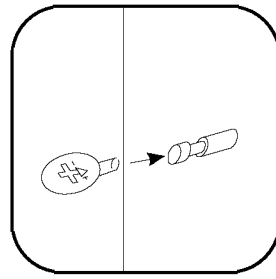
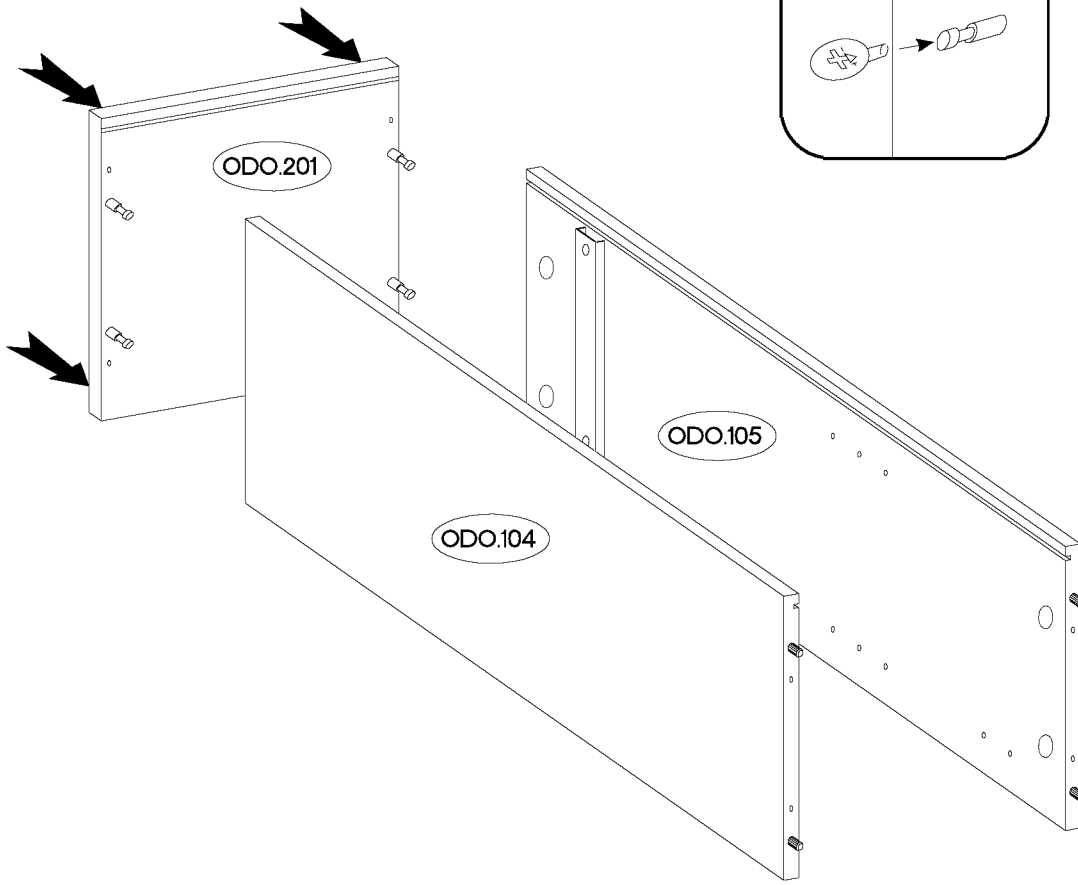



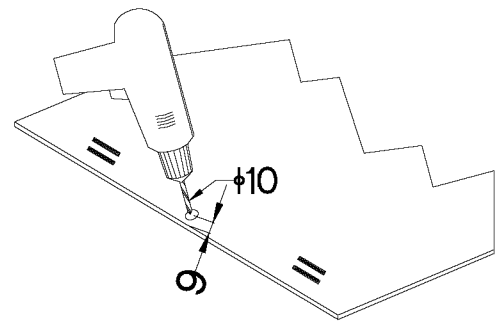
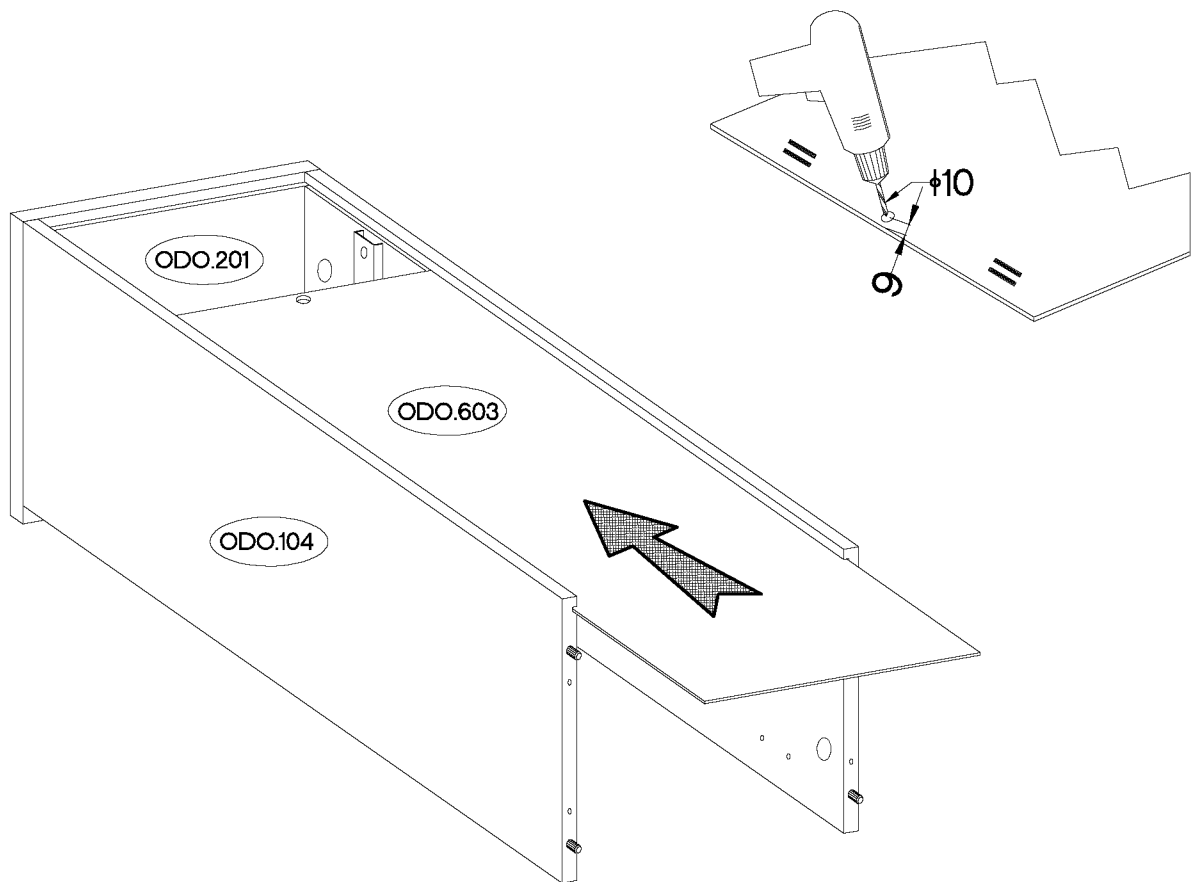

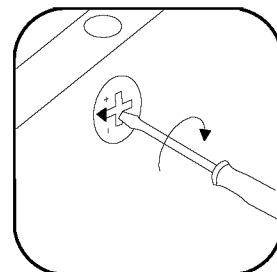
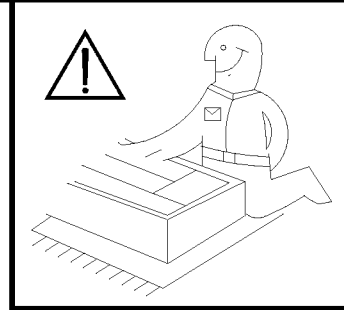
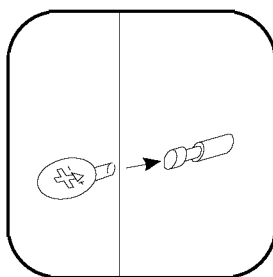
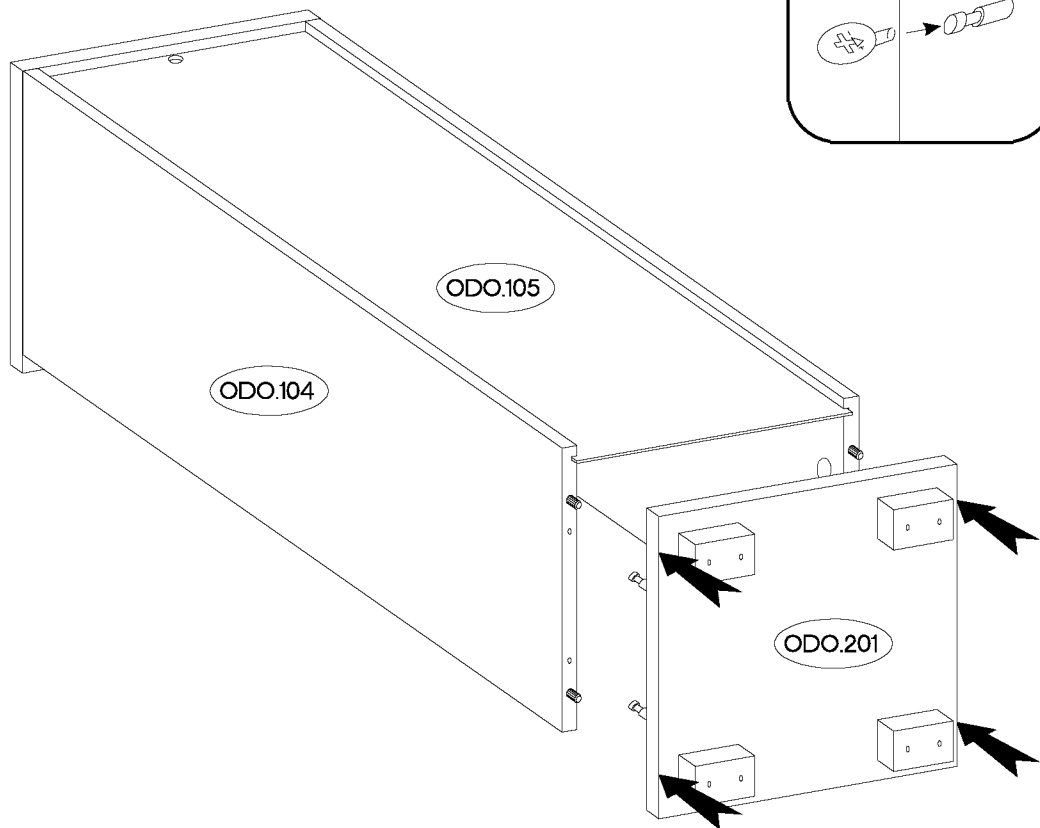
8



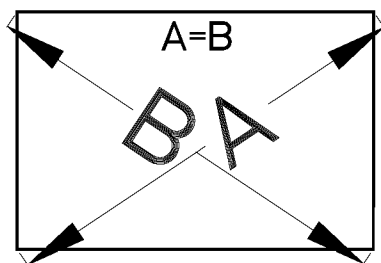
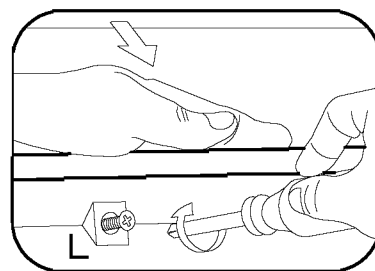
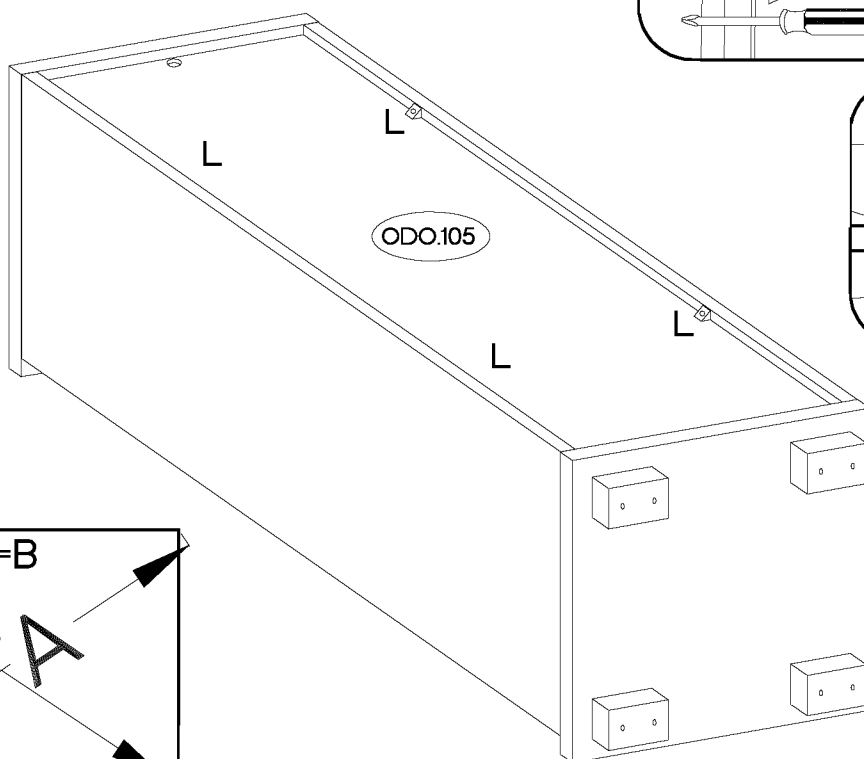
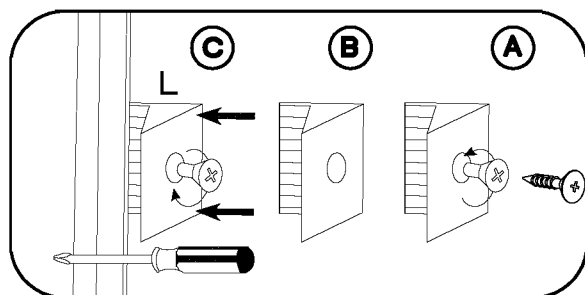
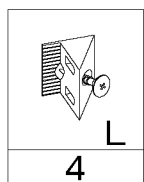





9

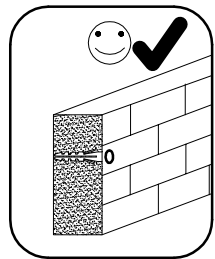
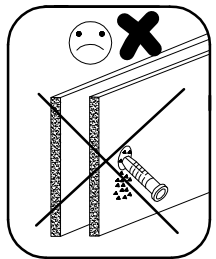
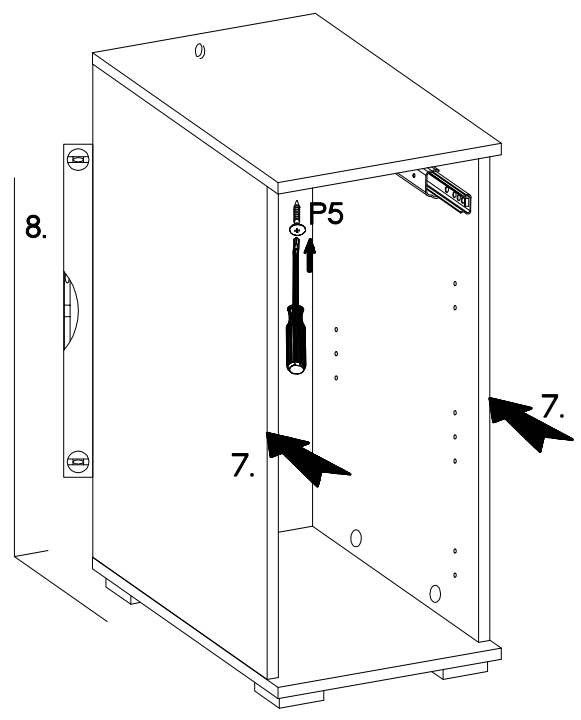
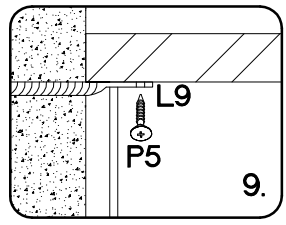
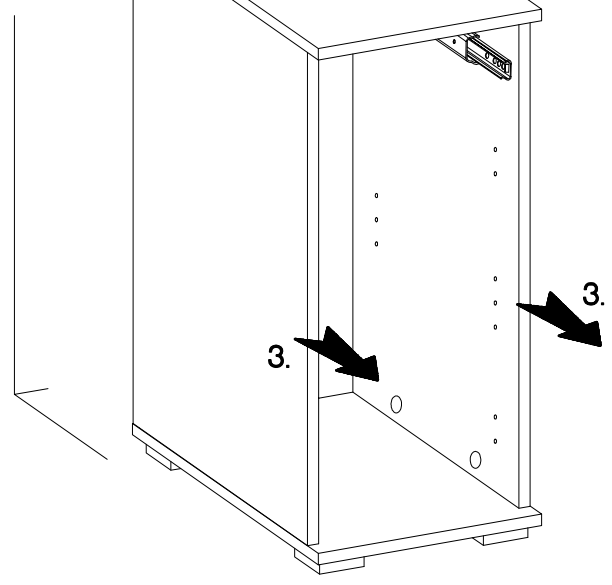
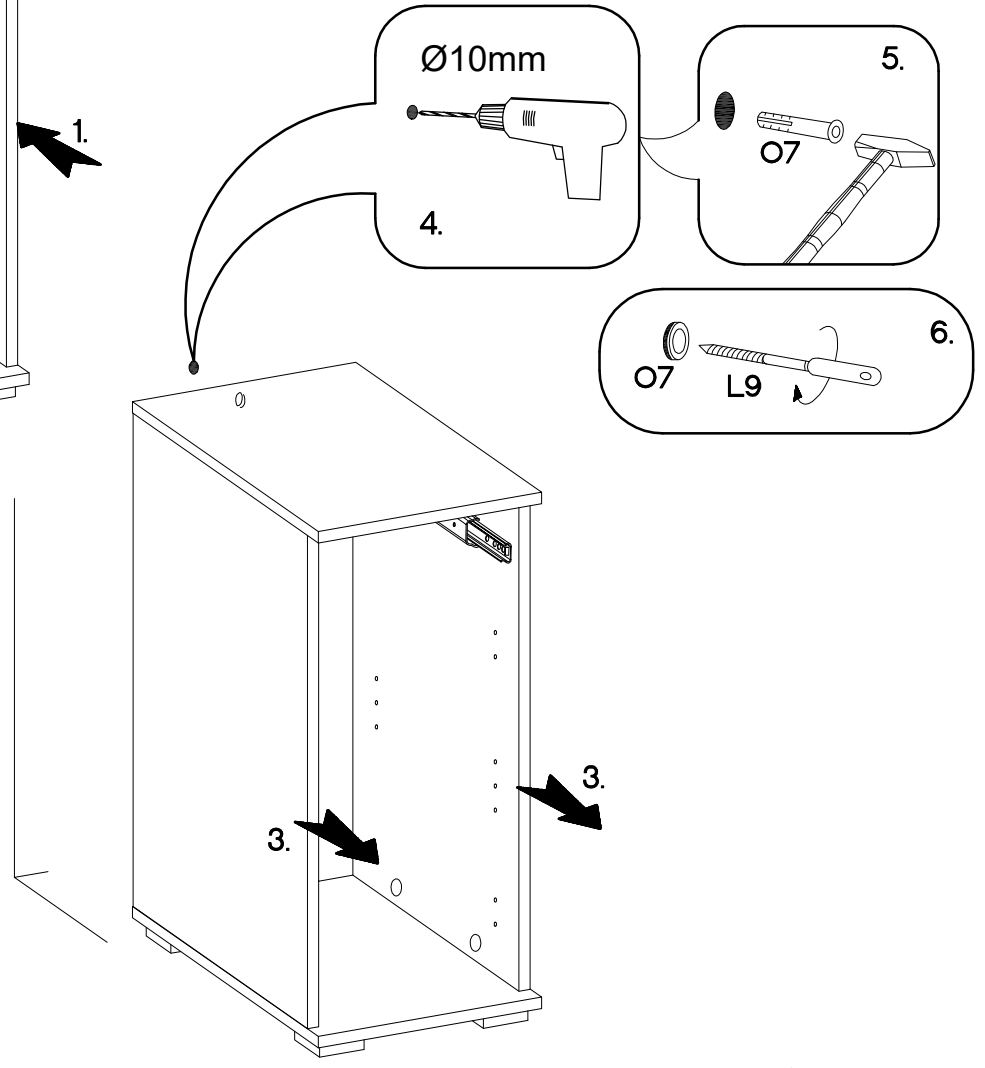
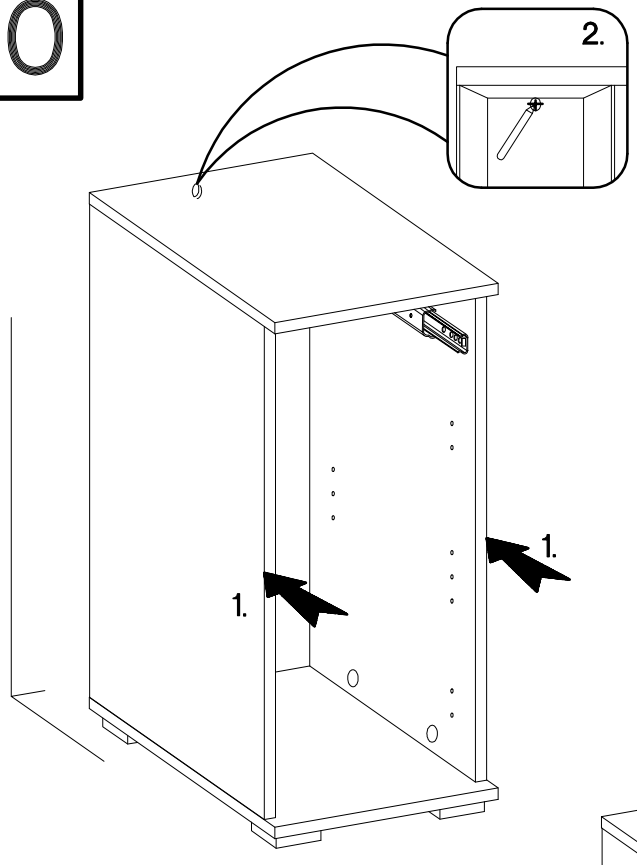

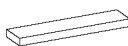

†10x50mm 		†3.5x13mm 
O7	L9	P5
1	1	1



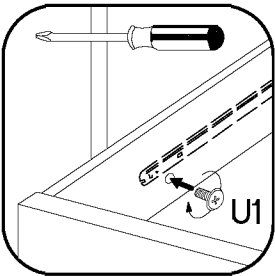
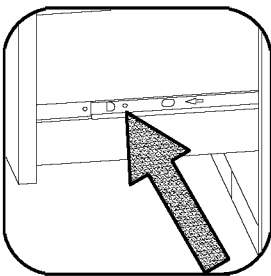
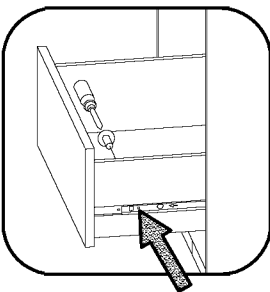
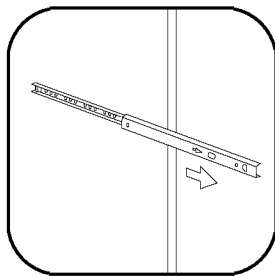
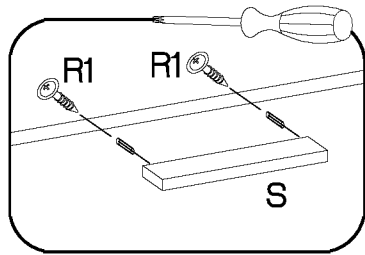
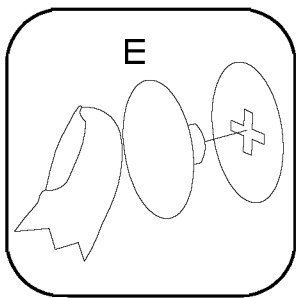
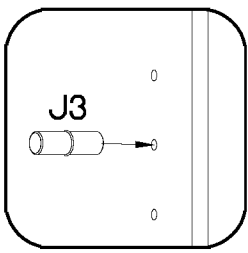
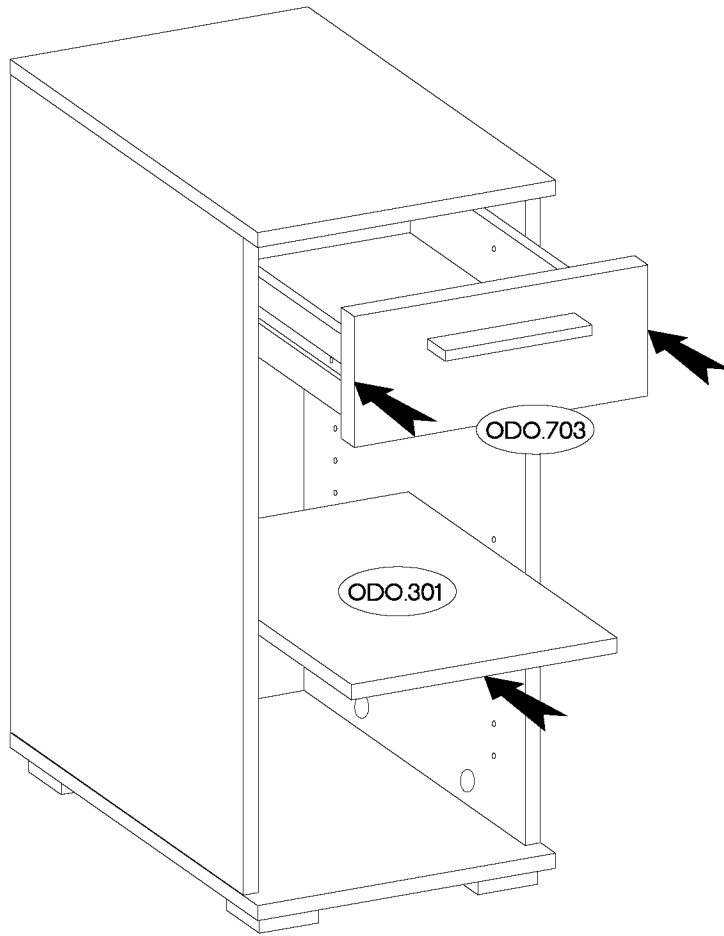

 J3 4	 E 2	 S 1	 R1 2	 U1 2
--	---	---	--	--

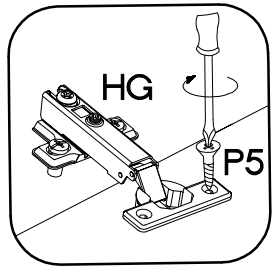
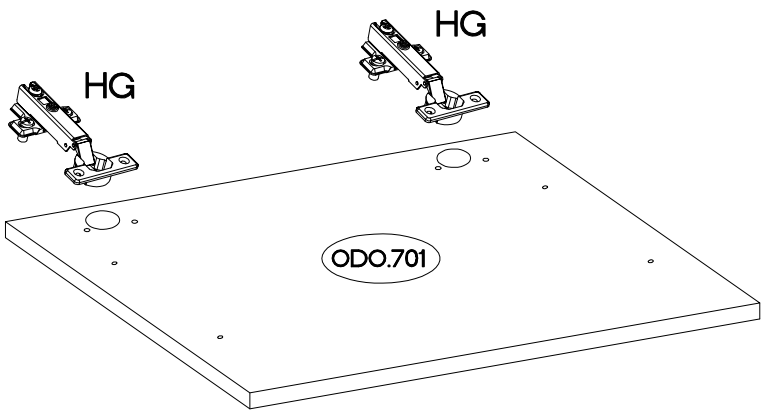
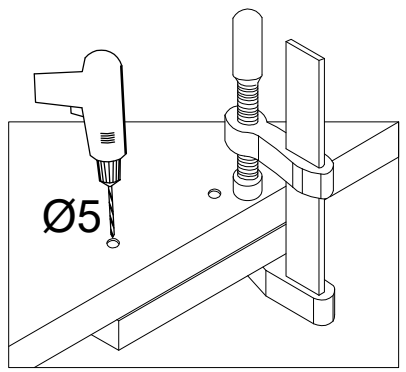
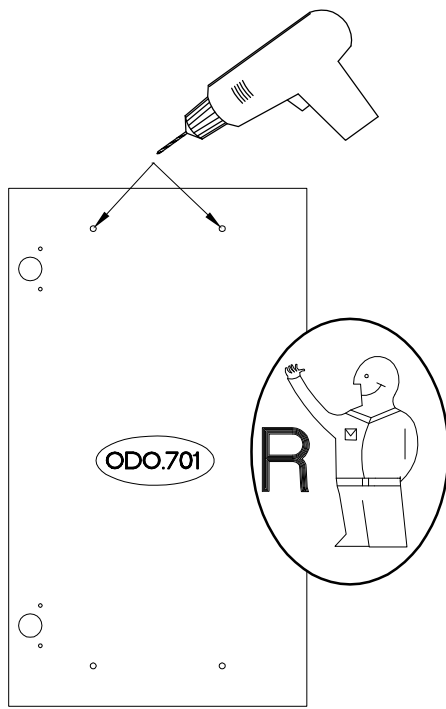
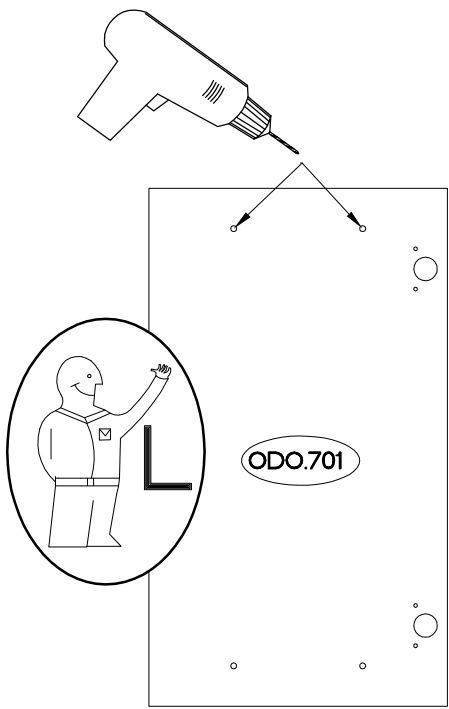
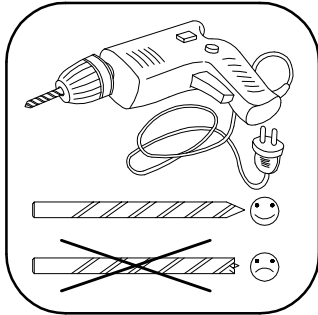

$\pm 35/0\text{mm}$  HG 2	$\pm 3.5 \times 13\text{mm}$  P5 4
--	---

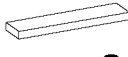

L=128mm	±4.0x27mm
	
S	R1
1	2

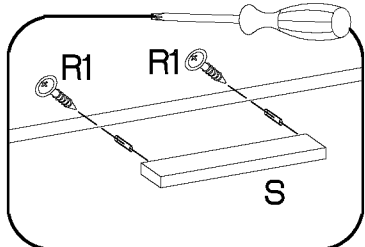
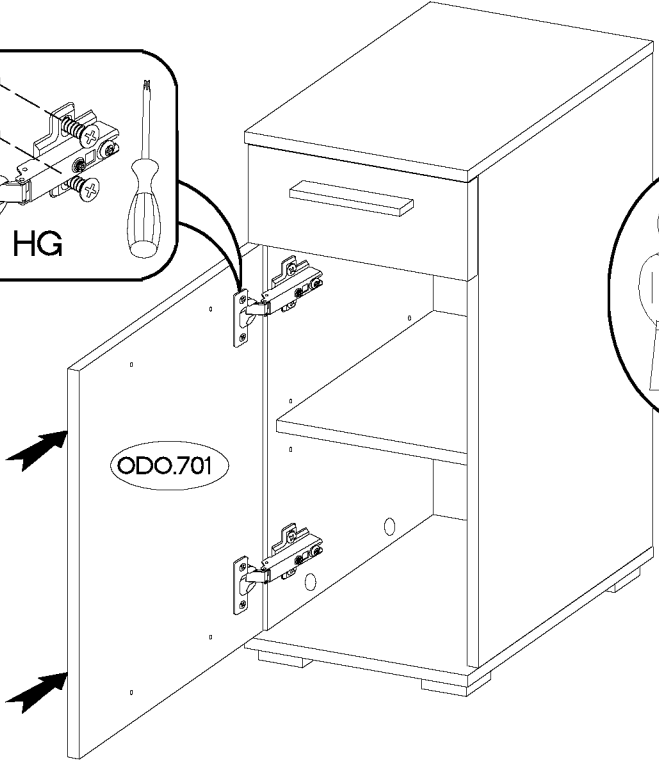
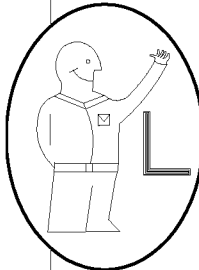
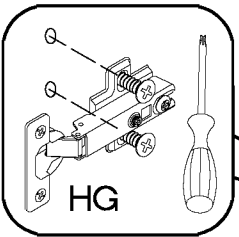
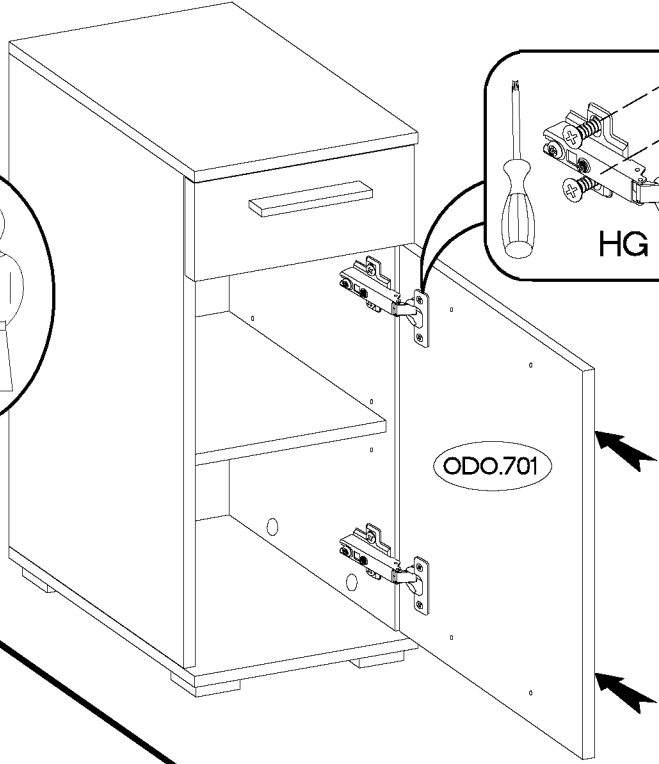
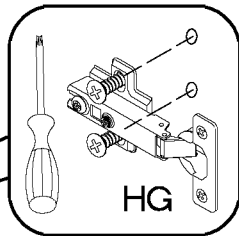
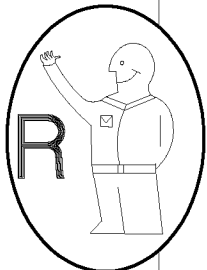

VARIANT HIGH GLOSS

