

3WSEHU24/3WSYHU24

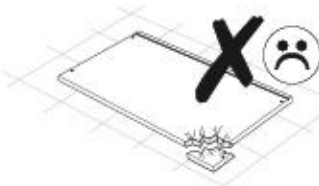
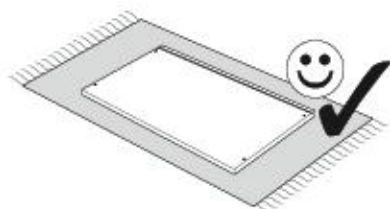
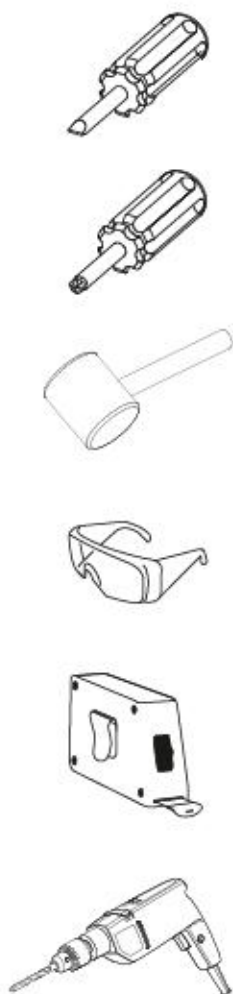
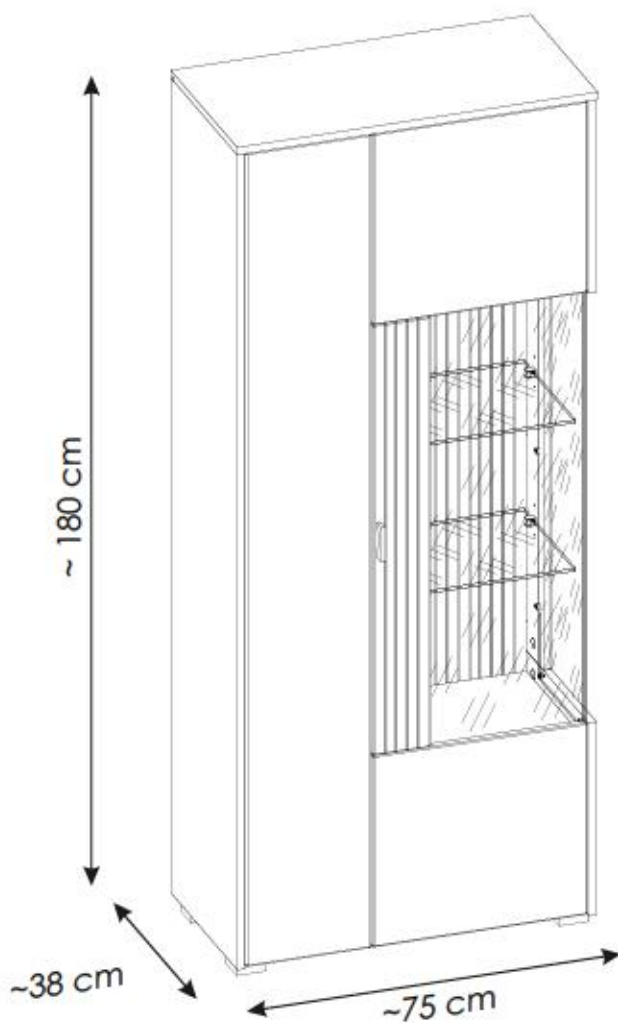

ملاحظة!

يجب تثبيت الأثاث بإحكام إلى الحائط أو الجدار لتجنب خطر إنقلابه. لا تحتوي العلبه على مسامير التثبيت، إذ إنه ينبغي إستعمال المسامير المخصصة لنوعية الحائط أو الجدار. اختر المسامير التي تناسب جدارك.

E.

¡ATENCIÓN! El mueble debe ser fijado permanentemente a la pared para evitar el riesgo relacionado con el vuelco del mueble. En el paquete no hay tornillos de fijación, ya que se debe elegir el tipo de fijación adecuado para el tipo de pared. Elija el apropiado para su tipo de pared.

CN.

注意！本家具需要固定在墙上以免倒塌。箱子里没有安装螺钉。因为安装方式需要根据墙的类型调整。请按照您的墙类型选择合适的安装方式。

SLO.

POZOR! Pohišivo trajno pritrđite na steno, da preprečite tveganje, da se prevrne. V paketu ni pritrđilnih vijakov, saj je treba način pritrđitve ustrezno izbrati glede na vrsto stene. Izberite način, ki je ustrezen za vašo steno.

HU.

FIGYELEM! Rögzítse a bútorokat a falhoz, hogy elkerülje a bútor felborulásának kockázatát. A készletben nem találhatóak rögzítőcsavarok, mivel a rögzítés típusa a fal típusától függ. Válassza ki a fal típusának megfelelő kötőelemeket.

NL.

OPMERKING! De meubelen moeten permanent aan de muur worden bevestigd om te voorkomen dat de meubelen kantelen. Er zitten geen bevestigingsschroeven in het pakket, omdat het type bevestiging moet worden gekozen op basis van het type muur. Kies de juiste voor uw type muur.

EN.

WARNING! To prevent this furniture from tripping over, fix it to the wall permanently. Fixing devices are not included since different wall materials require different types of fixing devices. Please make sure you chose the correct ones for your type of wall.

SK.

POZORI Nábytok musí byť trvalo pripevnený k stene tak, aby sa zamedzilo riziku prevrátenia. Balík neobsahuje upevňovacie skrutky, pretože typ upevnenia je treba vybrať podľa typu steny. Vyberte typ vhodný pre Vašu stenu.

CZ.

POZOR! Nábytek je nutné pevně připevnit ke zdi, abychom se vyhnuli riziku spojenému s jeho převrnutím. Součástí balení nejsou připevňovací šrouby, protože způsoby připevnění je nutné zvolit podle druhu stěny. Vyberte správný pro Váš typ stěny.

RU.

ПРИМЕЧАНИЕ! Эту мебель необходимо всегда прикреплять к стене, чтобы избежать рисков, связанных с переворотом мебели. В пакете нет крепежных винтов, потому что тип крепления должен быть выбран в соответствии с типом стены. Выберите, пожалуйста, правильные винты к вашей стене.

RO.

ATENȚIE! Mobila trebuie ancorată permanent în perete pentru a evita riscul de răsturnare a mobilei. În pachet nu sunt incluse șuruburile de fixare, deoarece tipul de ancoraj trebuie ales în funcție de tipul de perete. Alegeți șuruburile potrivite pentru tipul Dvs. de perete.

TR.

DIKKAT! Devrimle riskini önlemek için mobilya duvara sabitlenmelidir. Sabitleme civataları pakete dahil değildir, çünkü sabitleme tertibatının tipi, duvara tipine uygun olarak seçilmelidir. Onu duvannızın tipine göre seçiniz.

PL.

UWAGA! Mebel należy trwale zamocować do ściany, aby uniknąć ryzyka związanego z przewróceniem się mebla. W paczce nie ma śrub mocujących, ponieważ rodzaj mocowania należy odpowiednio dobrać do rodzaju ściany. Dobierz właściwe do Twojego rodzaju ściany.

D.

ACHTUNG! Um alle mit dem Umkippen des Möbels verbundenen Risiken auszuschließen, muss das Möbel fest an der Wand verankert werden. Beschläge für die Wandbefestigung sind nicht beige packt, da diese von der jeweiligen Wandbeschaffenheit abhängig sind. Bitte solche Befestigungsschläge wählen, die für die heimischen Wände geeignet sind.

FR.

ATTENTION! Ce meuble doit être fixé en permanence au mur pour éviter les risques de chute. Les vis de fixation ne sont pas livrées car le type de fixation doit être choisi en fonction du type de mur. Sélectionnez les fixations adaptées au mur.

I.

ATTENZIONE! Il mobile deve essere permanentemente fissato alla parete per evitare i rischi derivanti da un ribaltamento del mobile. La confezione non include le viti di fissaggio, in quanto il tipo di fissaggio deve essere scelto in base al tipo di parete. Utilizzare viti appropriate in base al materiale della parete.

HR.

NAPOMENA! Namještaj mora biti trajno pričvršćen za zid, kako bi se izbjegao rizik od njegovog prevrtanja. U paketu nema vijaka za pričvršćivanje, jer se vrsta montaže mora prilagoditi vrsti zida. Odaberite pravu vrstu prema Vašoj vrsti zida.

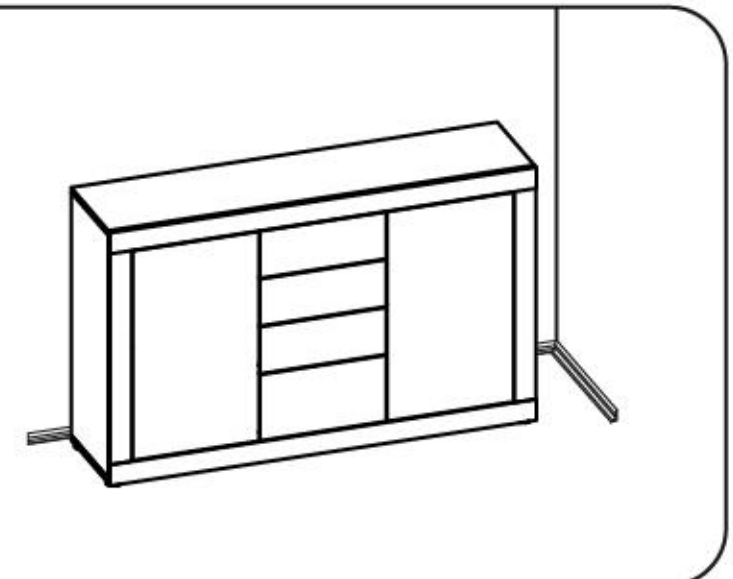
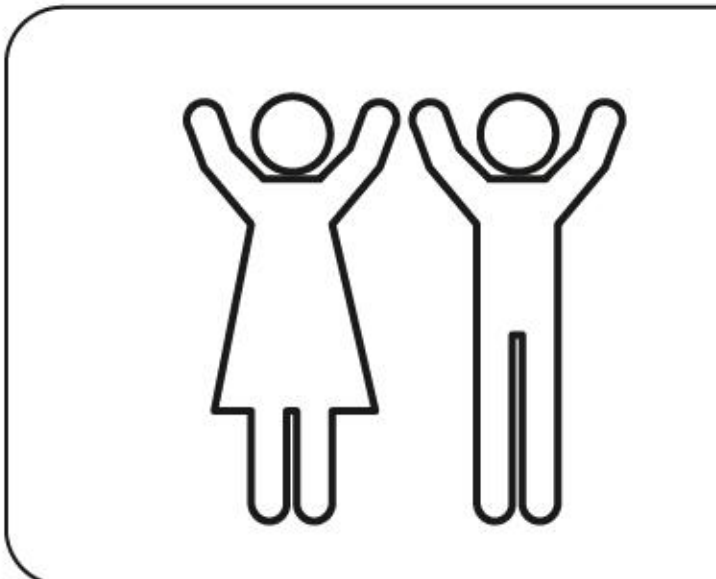
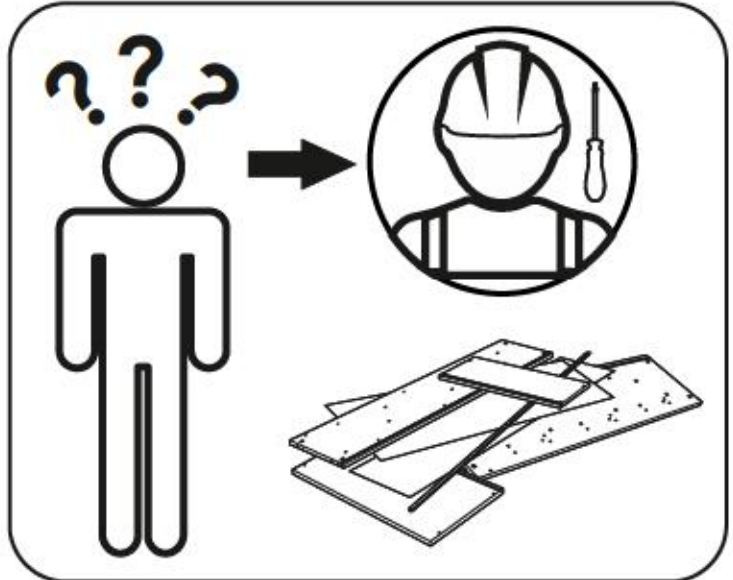
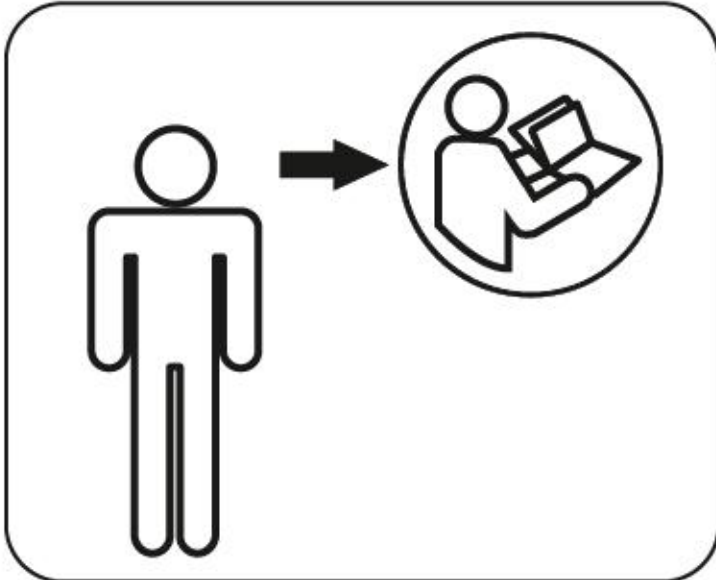
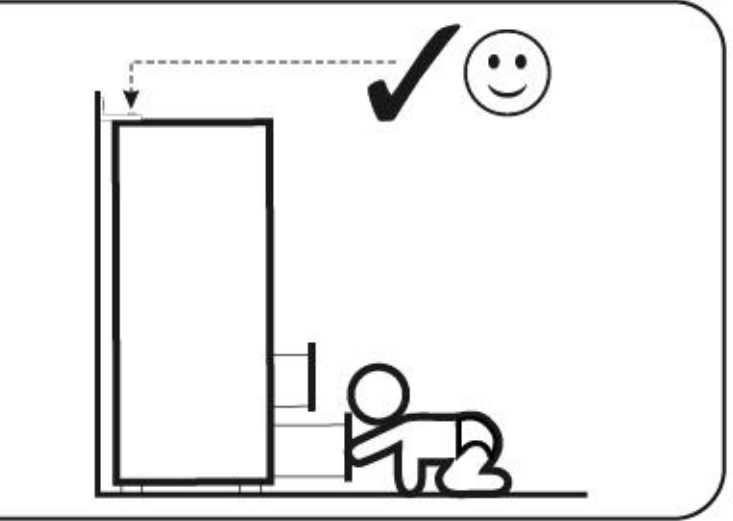
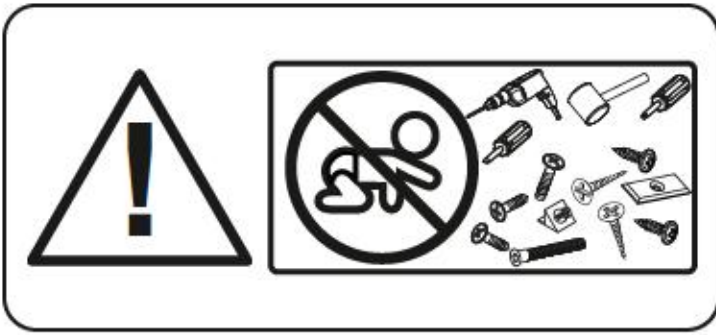



version A

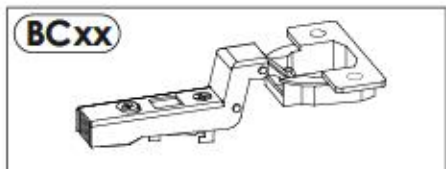



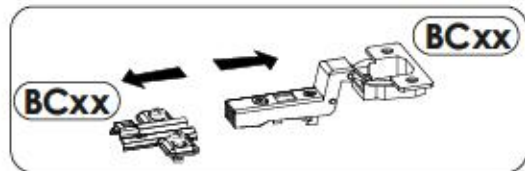
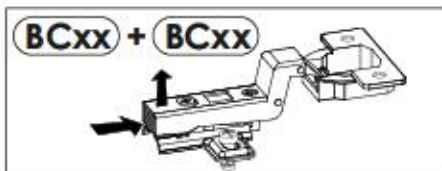



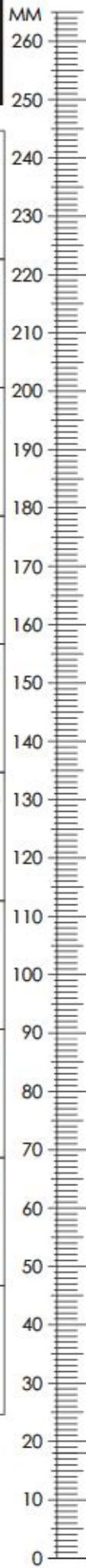









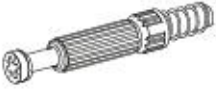



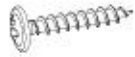

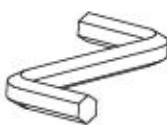
version B

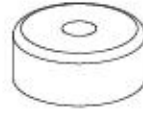
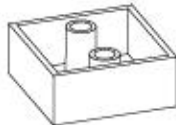

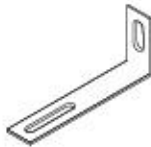
3WSEHU24/3WSYHU24

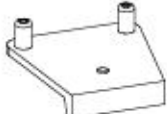
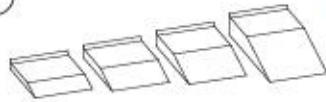

A1 8 x 35 mm x24 	A8 6 x 45 mm x8 	BC15 + BC16 x7 
C2 5 x 13 mm x20 	D2 x12 	D5 x6 
E0 Ø16 x18 	E1 15 x 12 mm x22 	E4 12 x 10 mm x8 
F1 6 x 34 mm x22 	F3 7 x 64 mm x4 	G1 7 x 50 mm x2 
H1 L - 75 mm x1 	I2 4 x 16 mm x10 	I3 3.5 x 22 mm x1 
I13 4 x 30 mm x8 	K7 4 x 22 mm x2 	M x1 
N0 3 x 13 mm x1 	N1 3 x 16 mm x35 	O1 x1 
O6 x4 	P17 x8 ø20 	Q9 x2 
R1 x19 	R2 x6 	R3 x8 
R4 x12 	R5 x1 	Z x1 

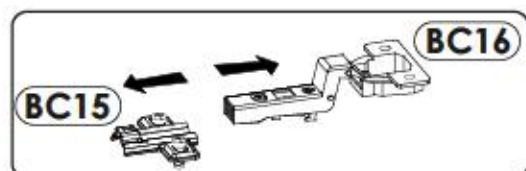

3WSEHU24/3WSYHU24

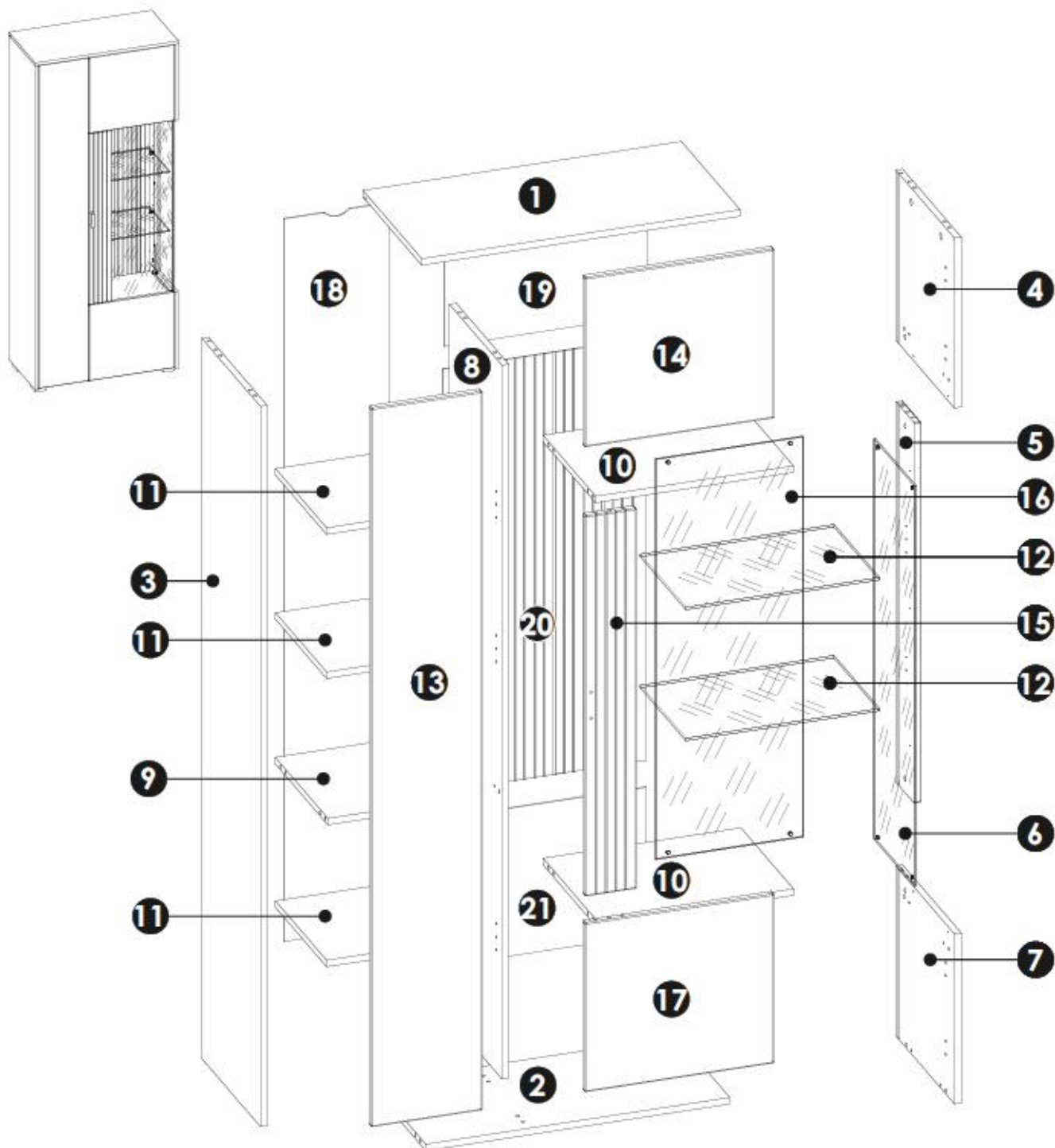

1	750	380	16 x1	1/2
2	716	340	16 x1	2/2
3	1759	379	16 x1	1/2
4	415	379	16 x1	1/2
5	929	120	16 x1	1/2
6	977	262	4 x1	2/2
7	415	379	16 x1	1/2

8	1743	340	16 x1	2/2
9	234	340	16 x1	1/2
10	466	340	16 x2	2/2
11	233	330	16 x3	1/2
12	456	305	6 x2	2/2
13	1755	261	16 x1	2/2
14	413	446	16 x1	1/2

15	929	120	16 x1	1/2
16	977	347	4 x1	2/2
17	413	446	16 x1	1/2
18	1765	248	3 x1	2/2
19	369	480	3 x1	1/2
20	1031	480	3 x1	1/2
21	361	480	3 x1	1/2

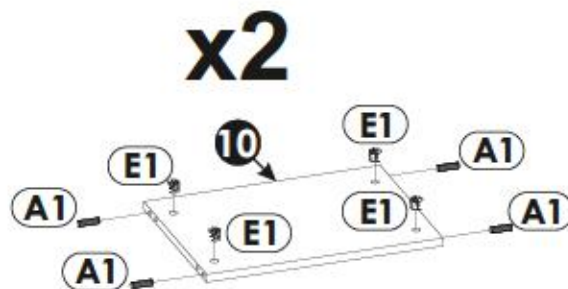
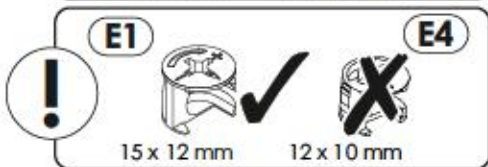
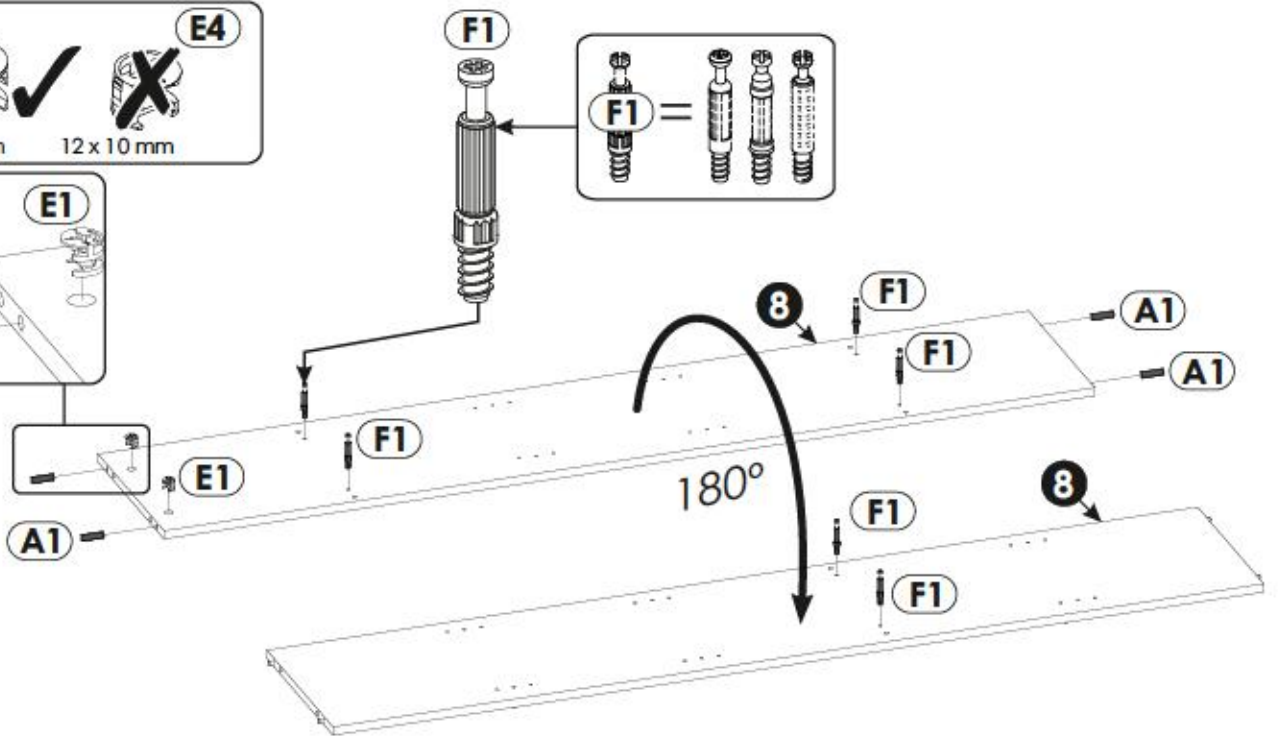
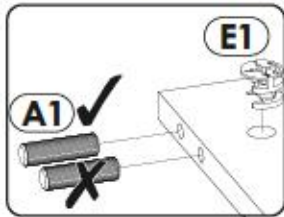
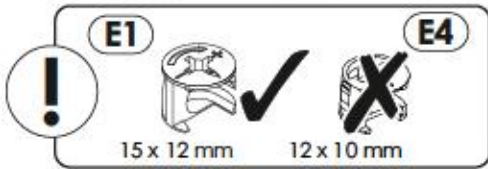
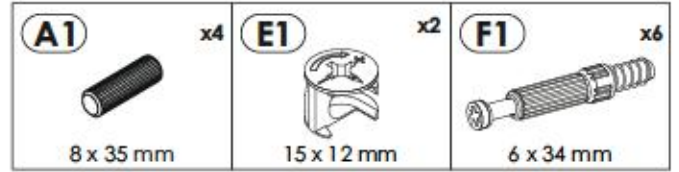
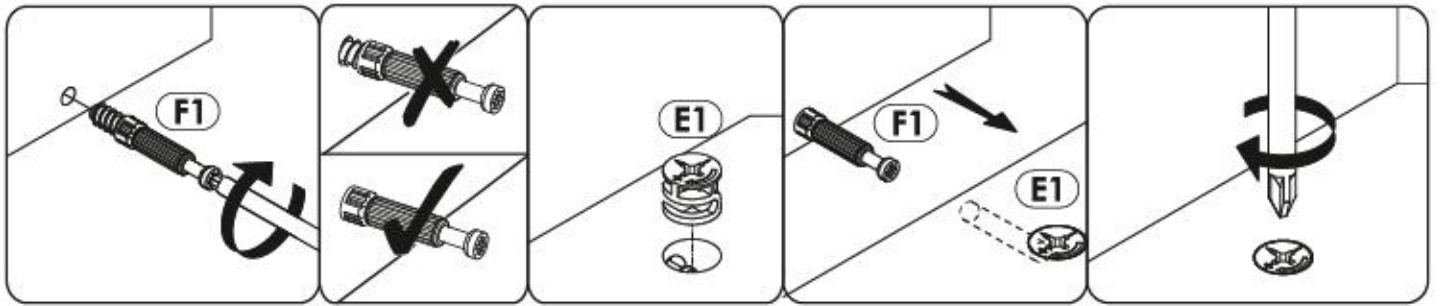

3 ▶

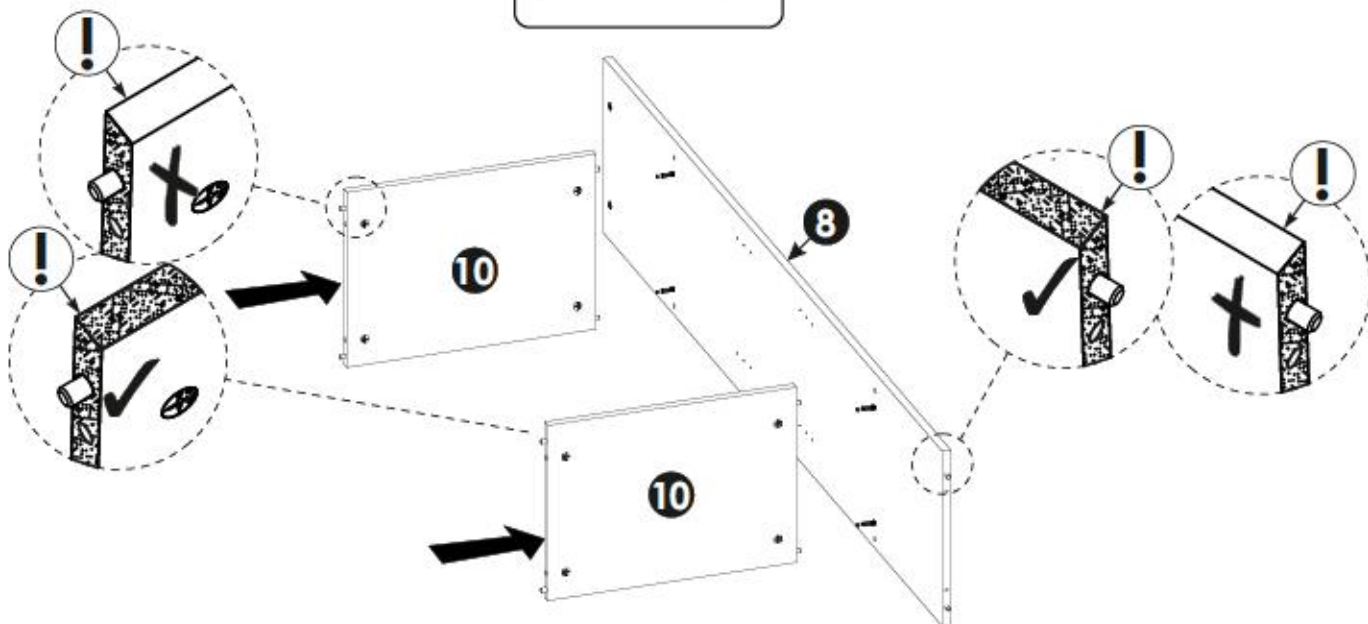
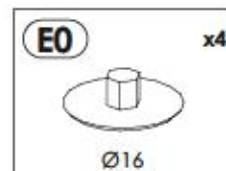
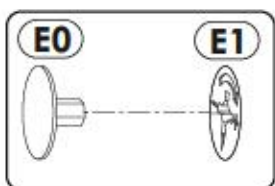
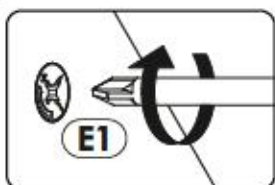
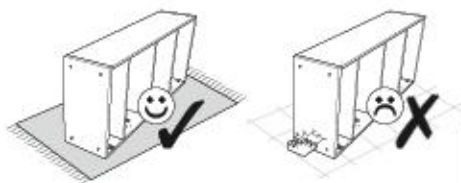

4 ▶

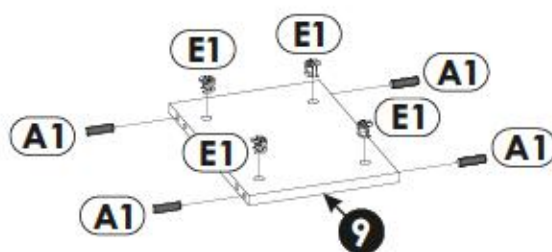

5 ▶

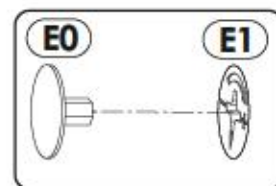
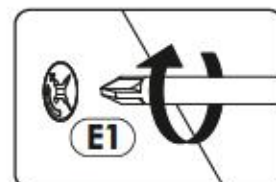
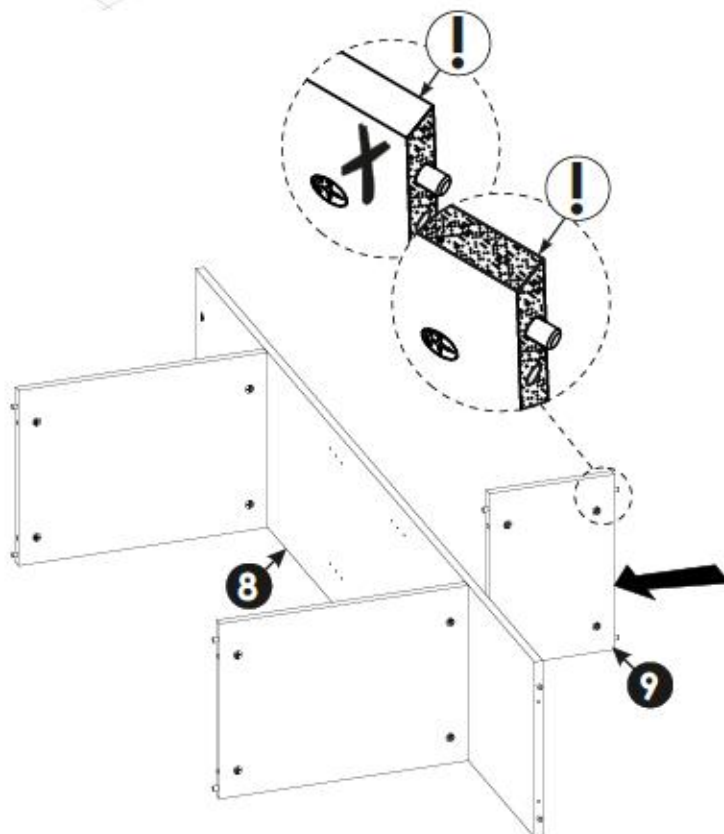
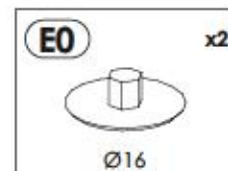
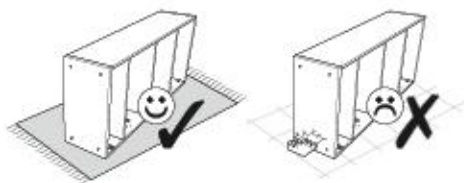

6 ▶

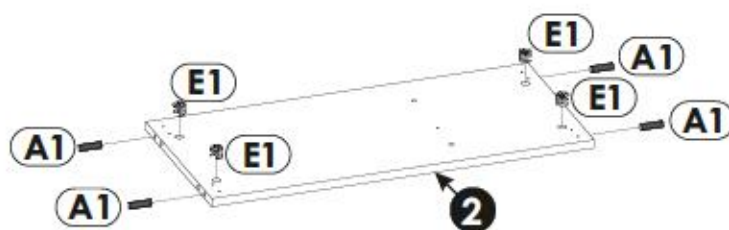

7 ▶

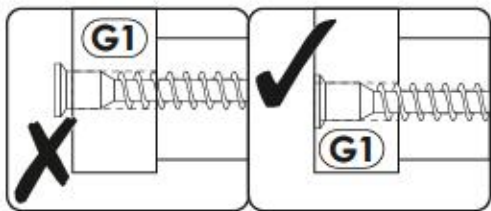
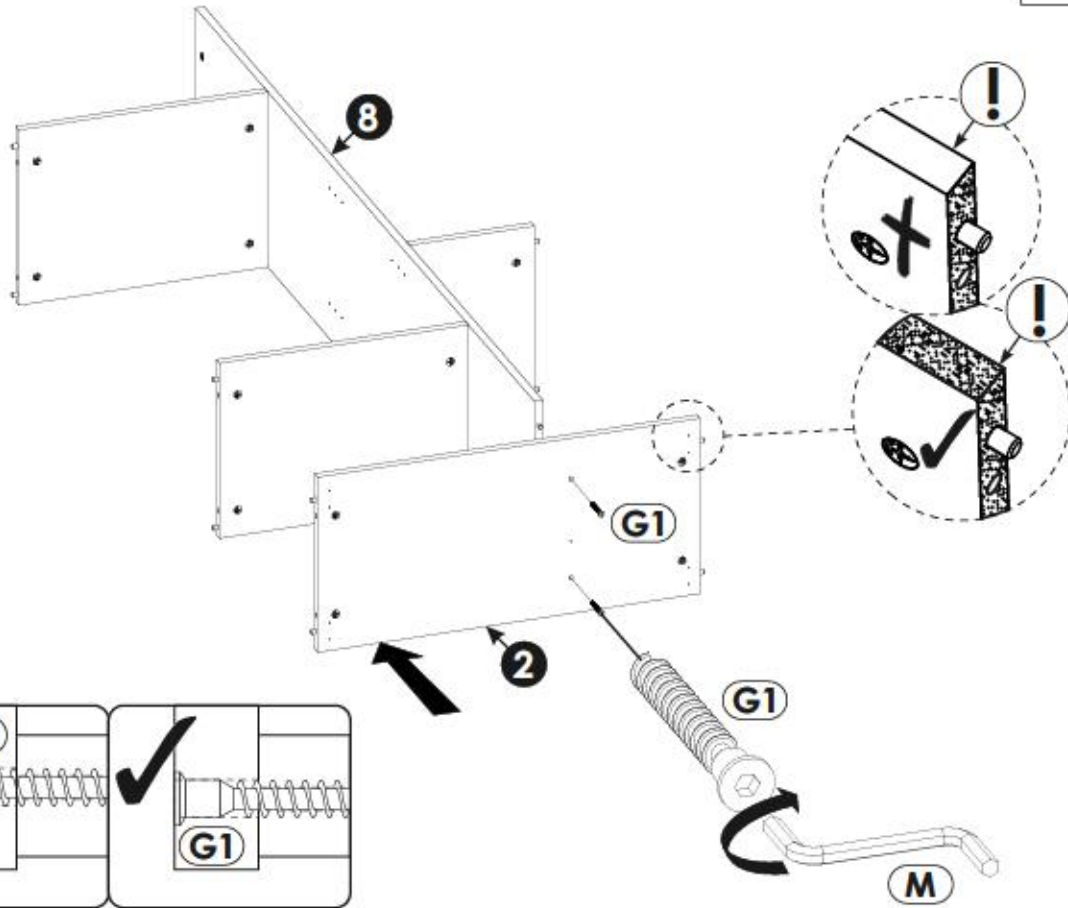
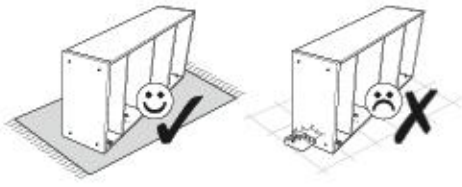

8 ▶

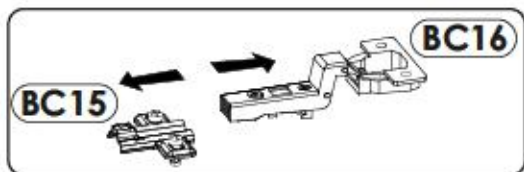
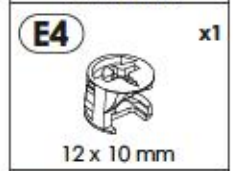
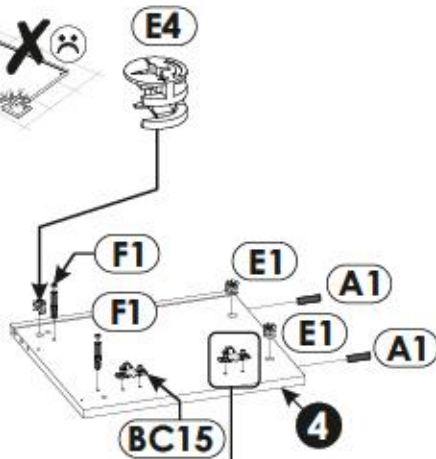
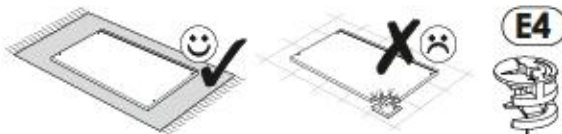

9 ▶

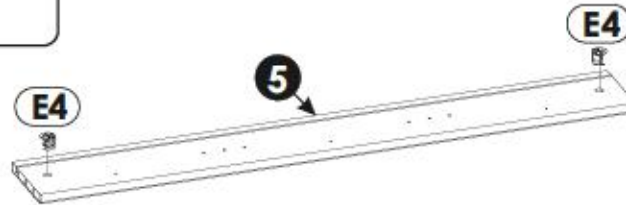
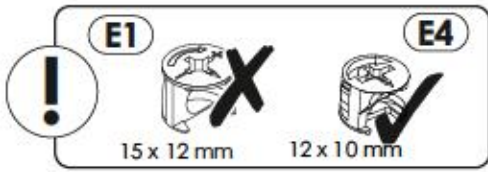
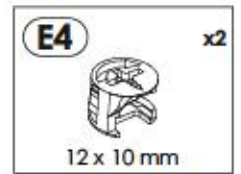

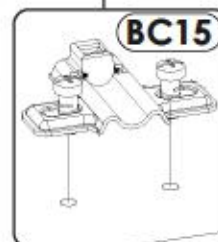
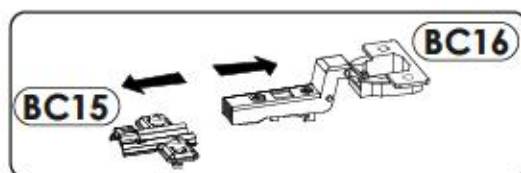
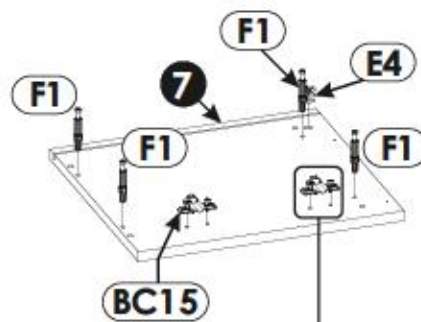
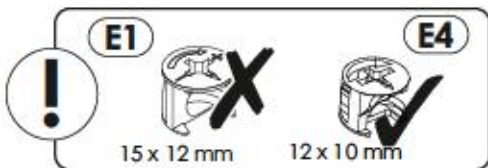

10 ▶

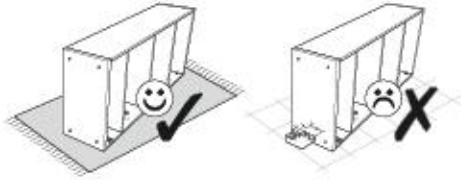

11 ▶



A8  6 x 45 mm	x4	F3  7 x 64 mm	x2	P17  ø20	x4
---	----	---	----	--	----

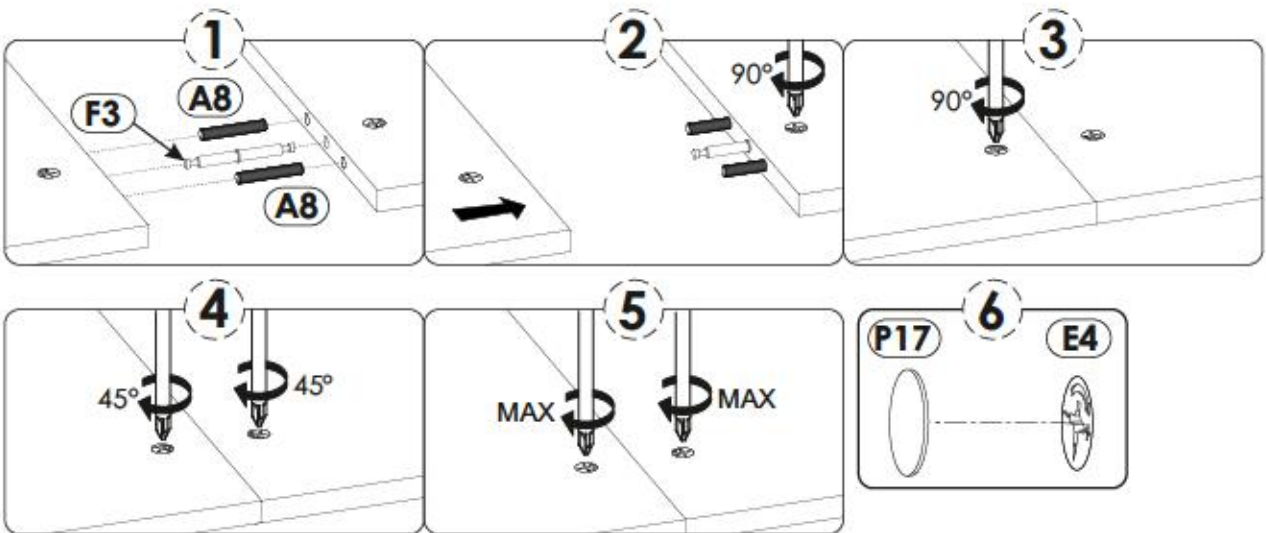
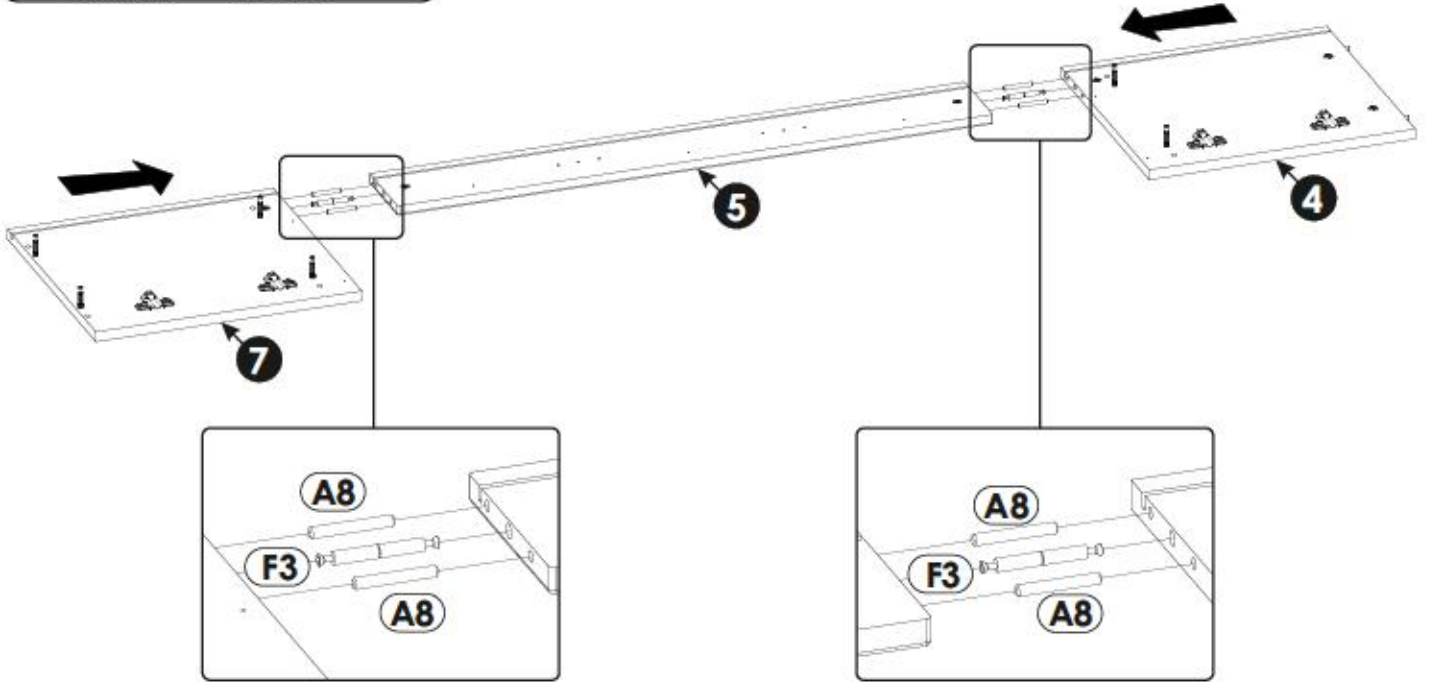
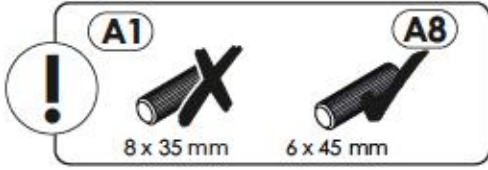

12 ▶

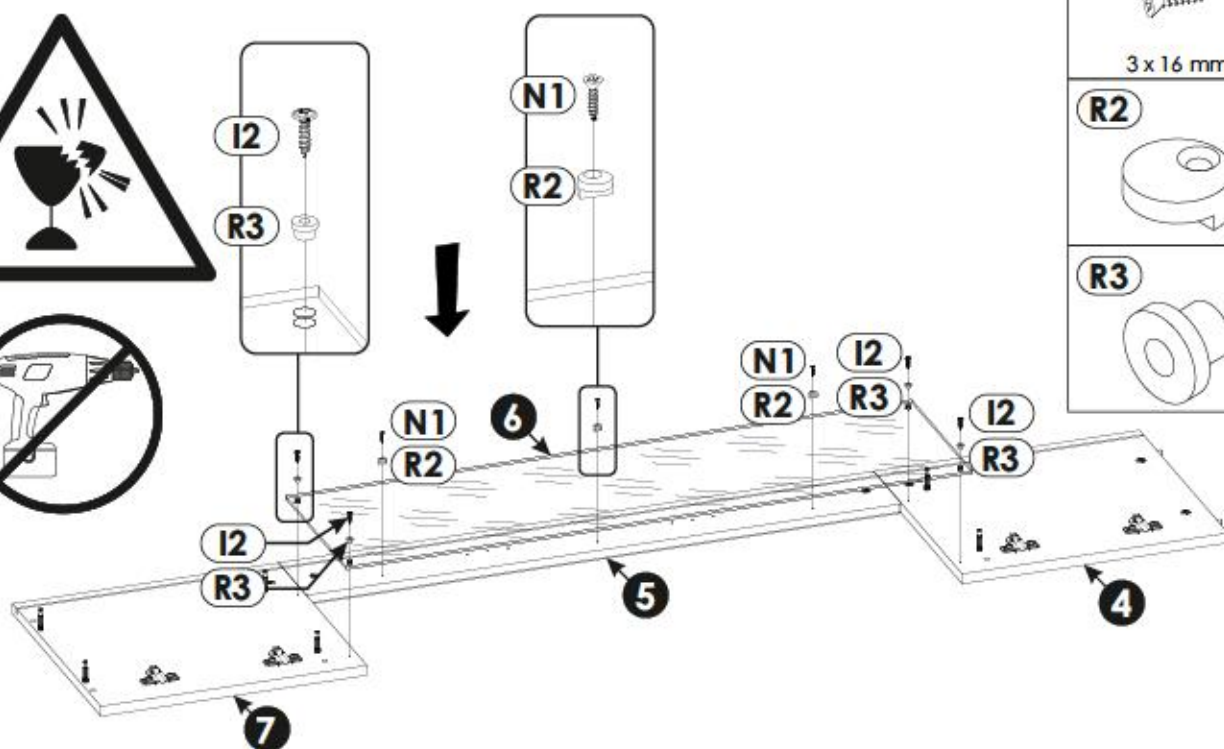
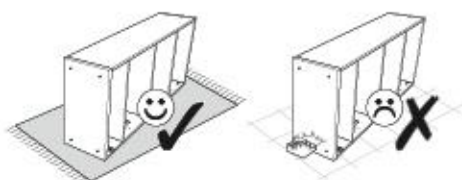

I2	x4
4 x 16 mm	
N1	x3
3 x 16 mm	
R2	x3
R3	x4

13 ▶

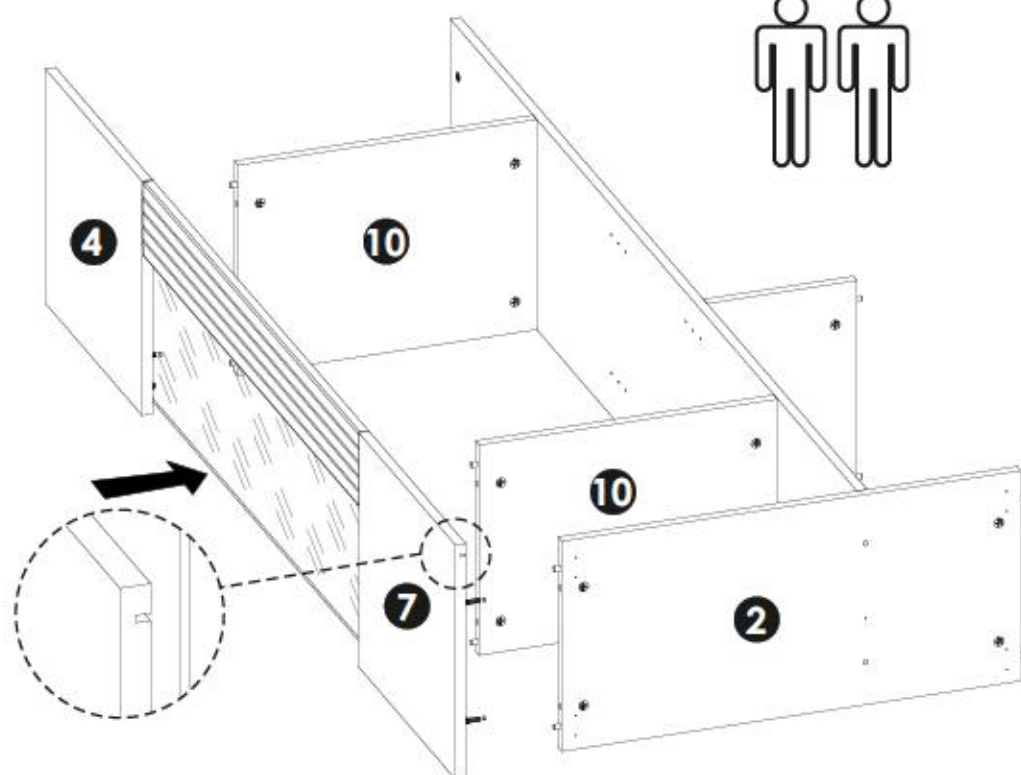
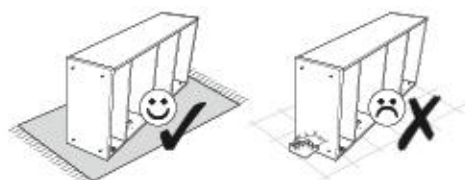

E0	x4
Ø16	

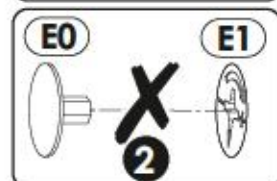
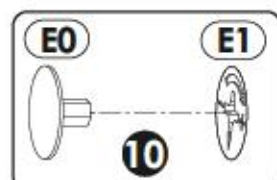
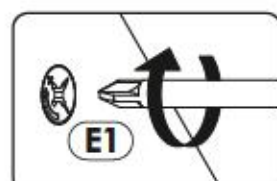

14 ▶

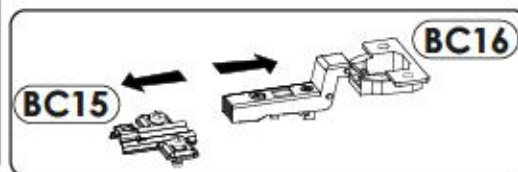
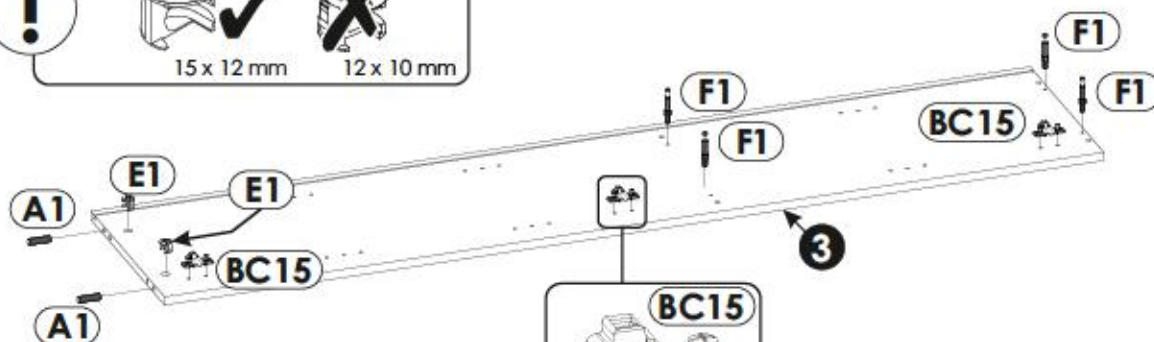

15 ▶

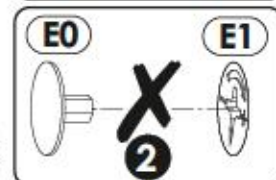
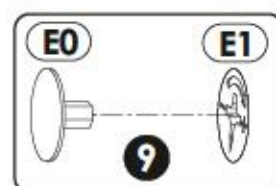
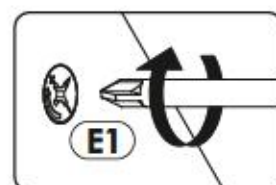
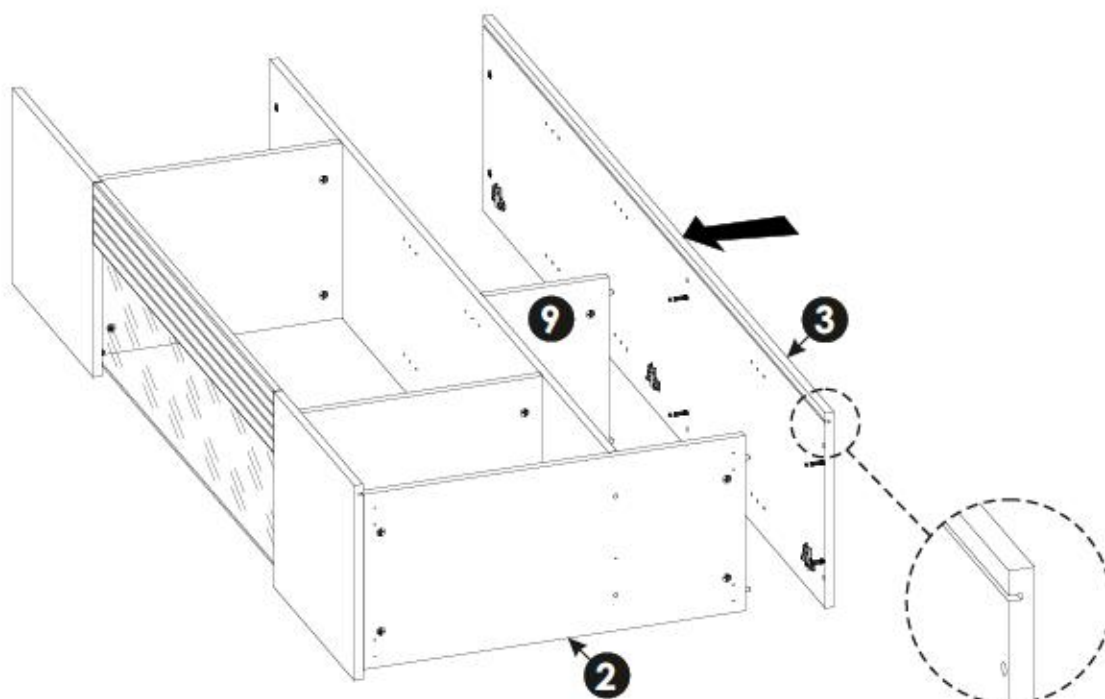
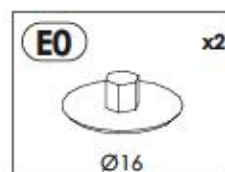
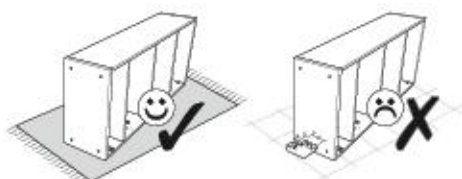

16▶

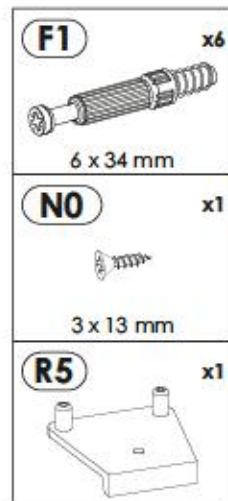
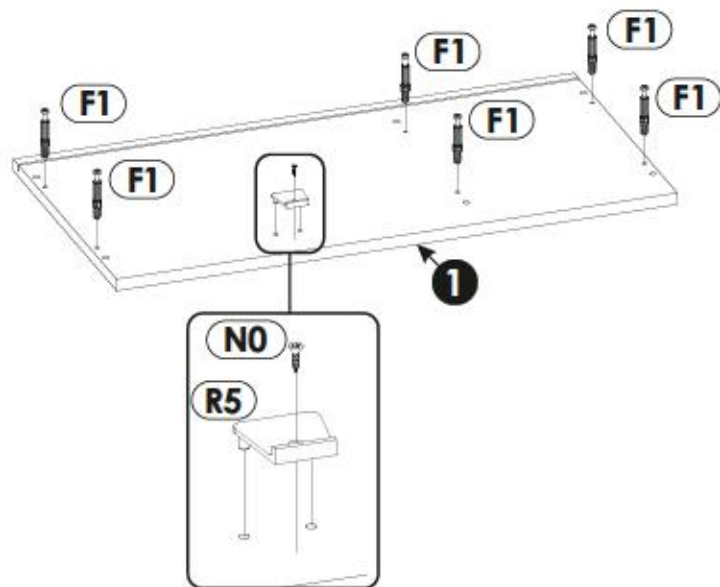

17▶

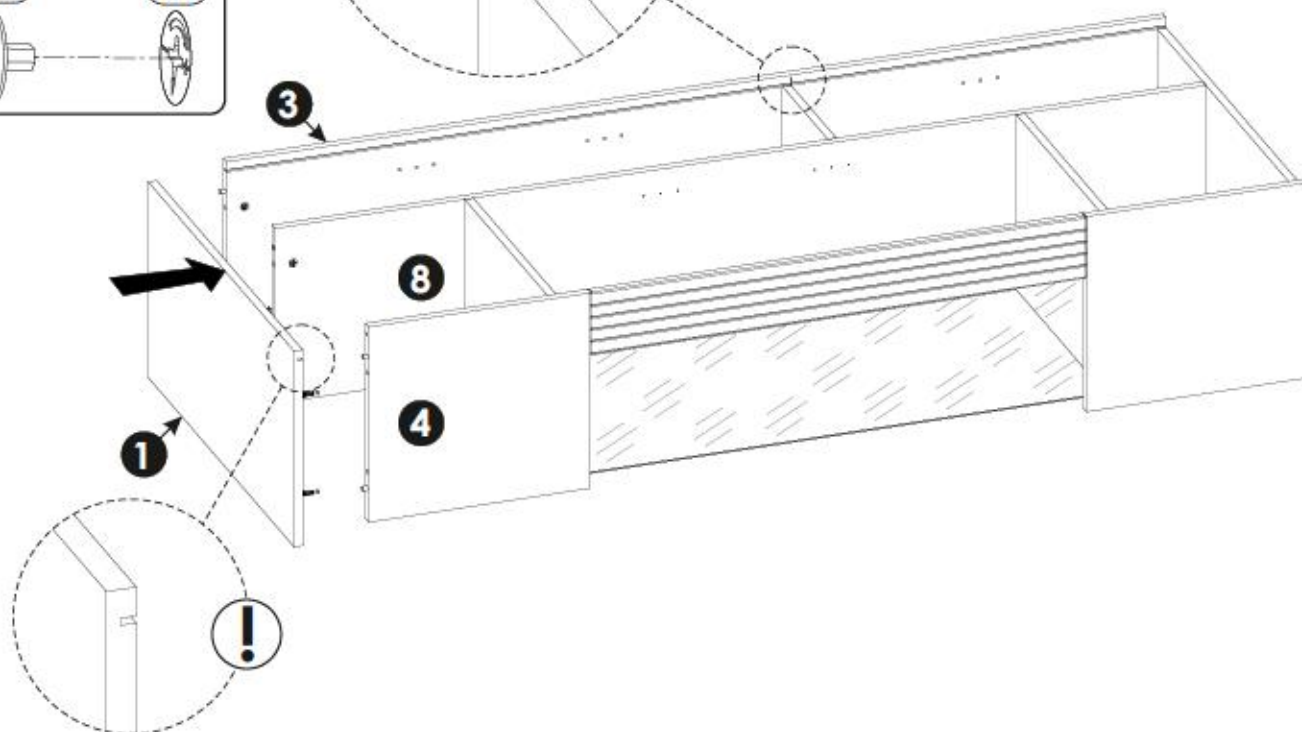
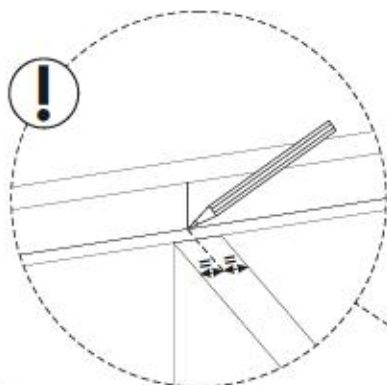
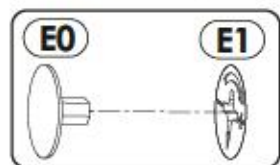
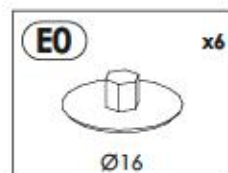
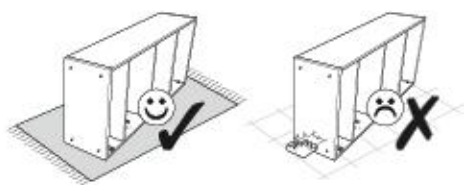

18▶

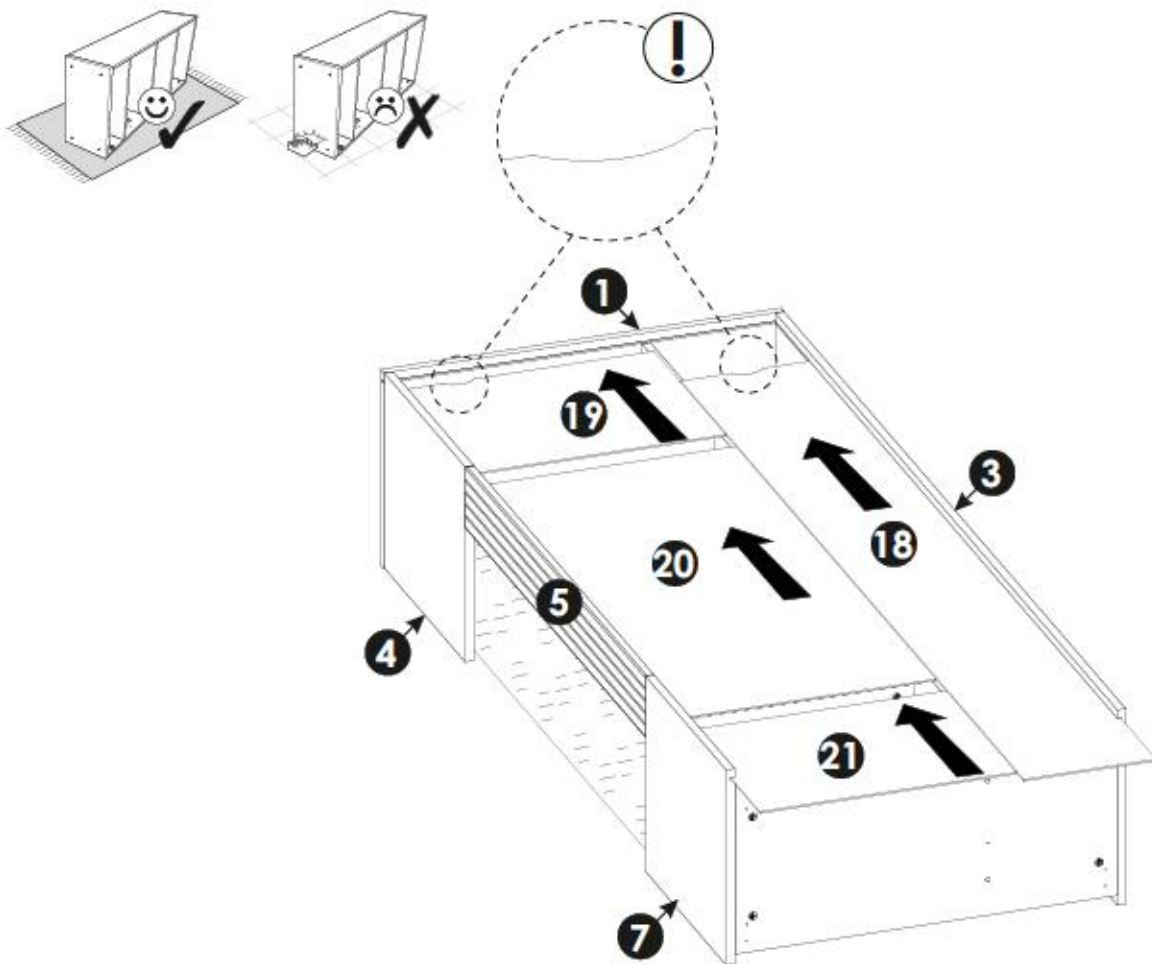

19▶

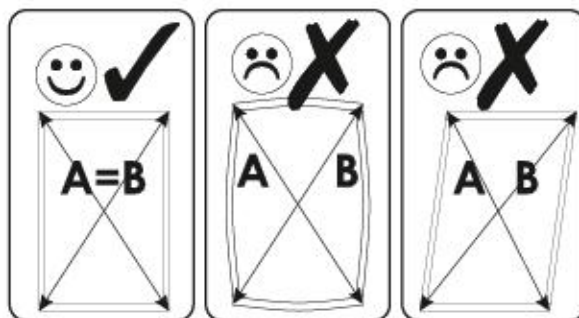
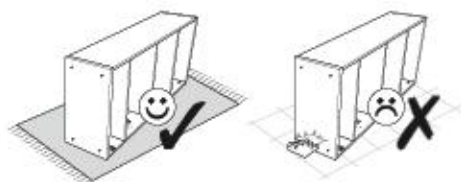

A=B

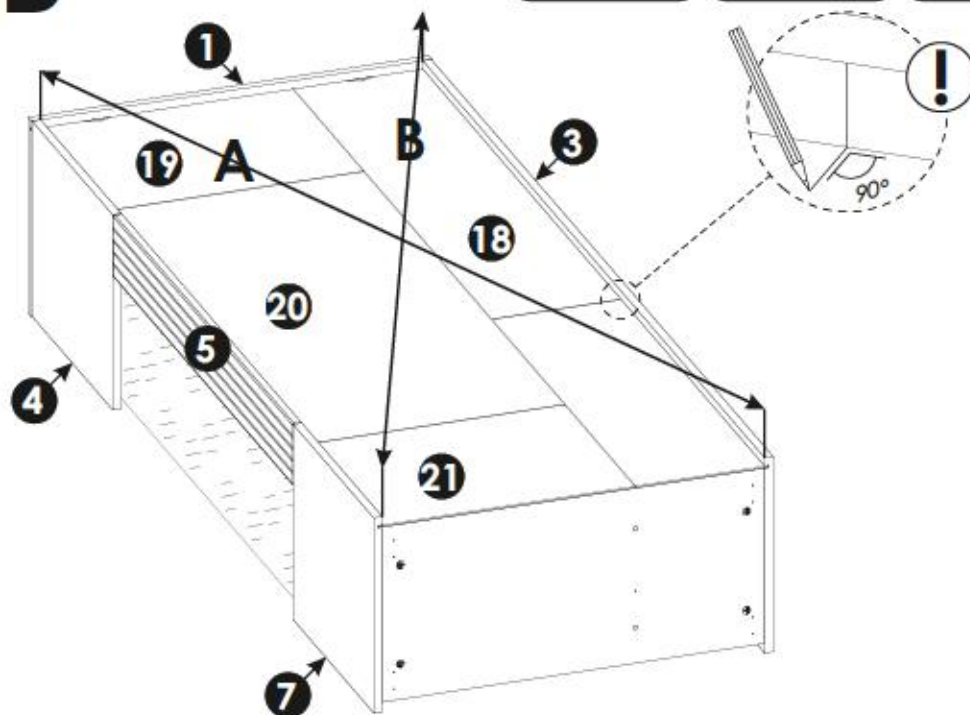

20 ▶

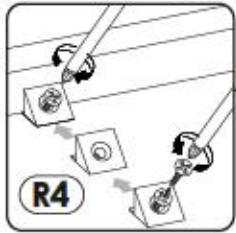
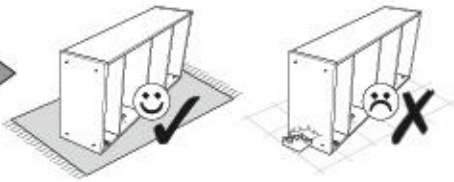

x12

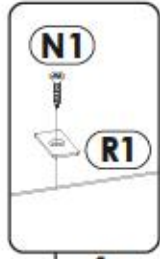
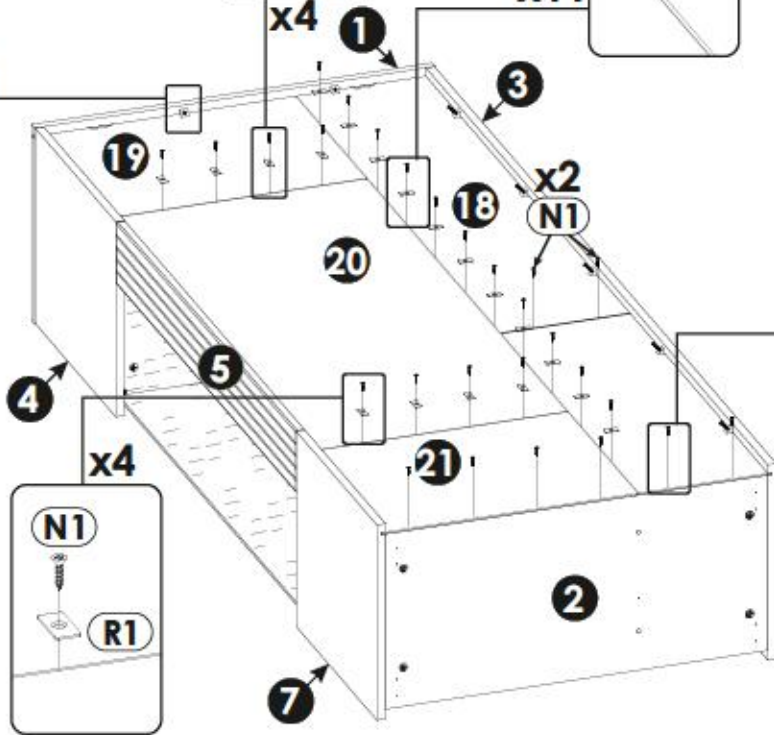

x4

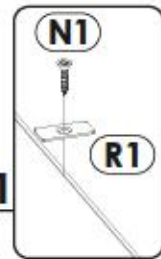

x11

N1	x27
3 x 16 mm	
R1	x19
R4	x12

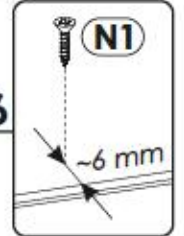

x6

21 ▶

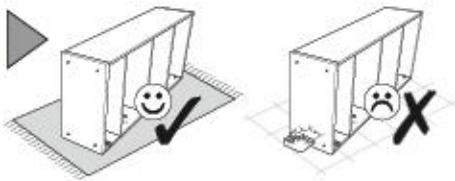

I3	x1	I13	x8	O1	x1	O6	x4
3,5 x 22 mm		4 x 30 mm					

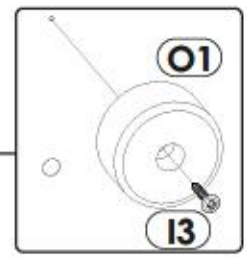
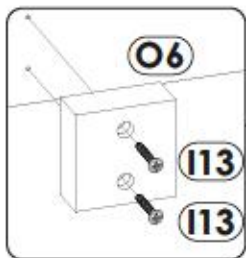
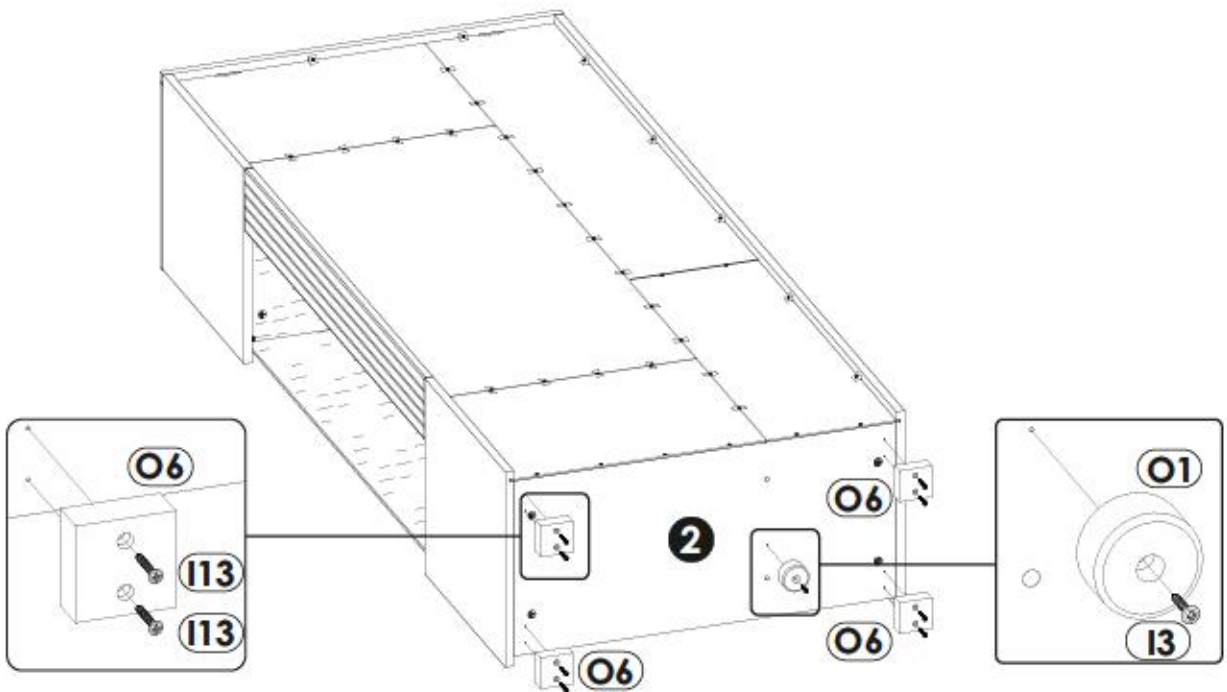

22 ▶

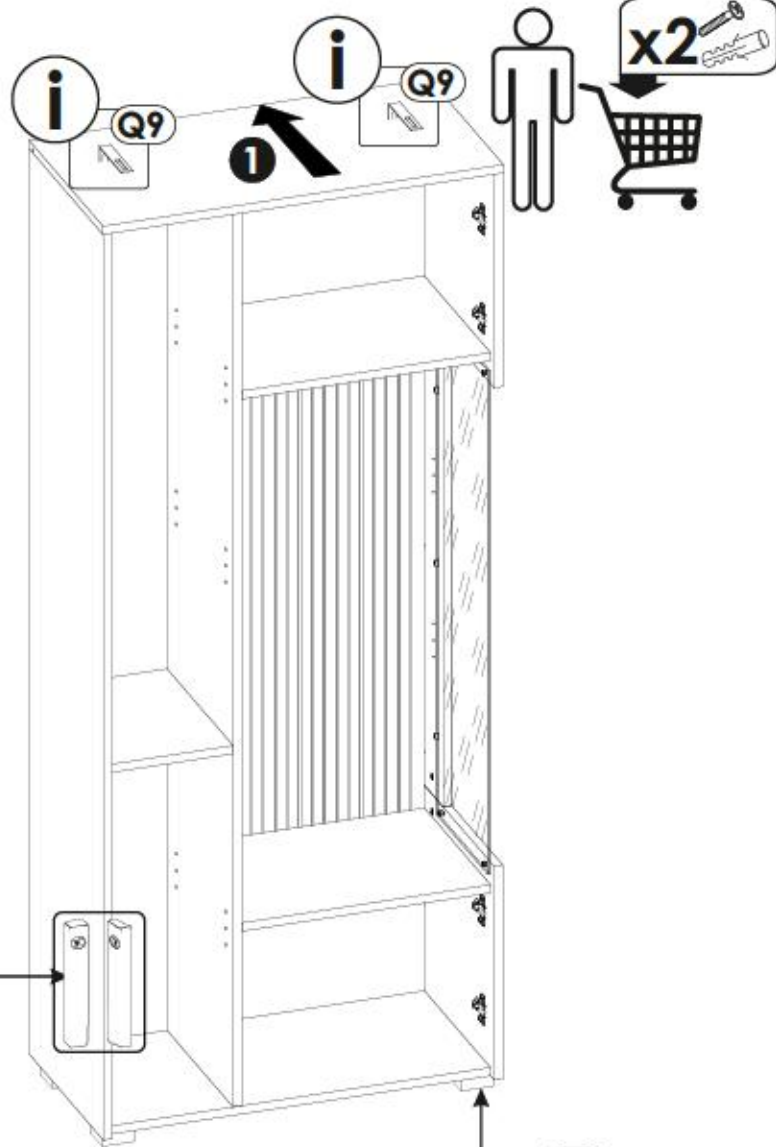

I2	x2
	4 x 16 mm
Q9	x2
Z	x1

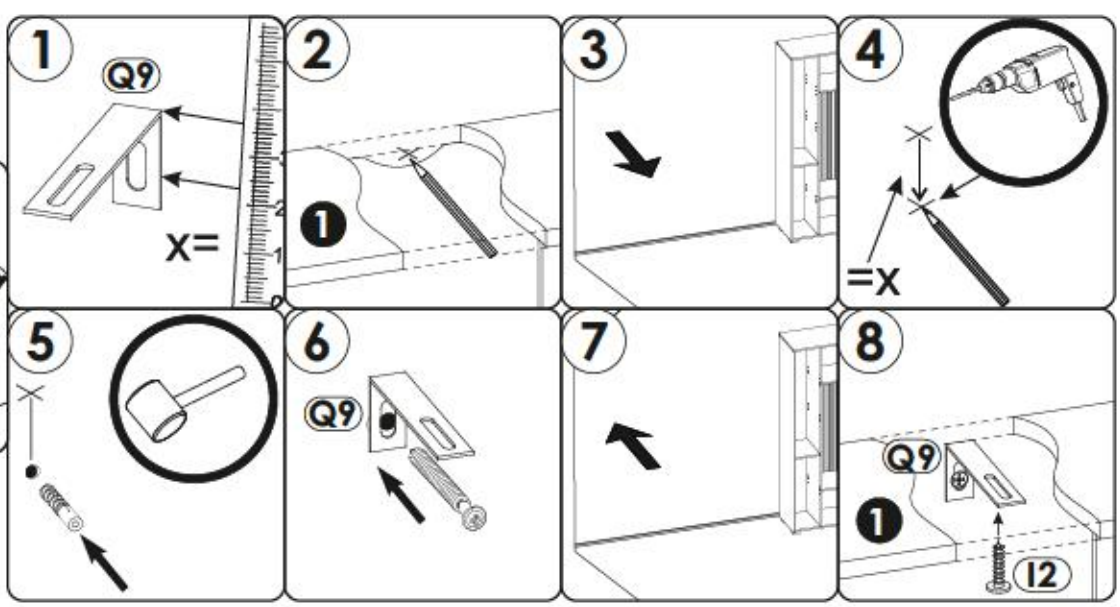
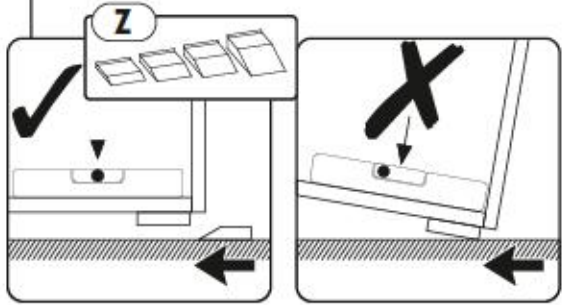
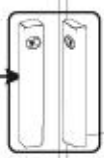
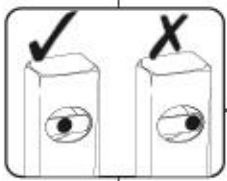

23▶

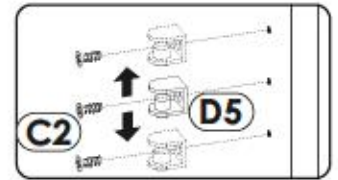
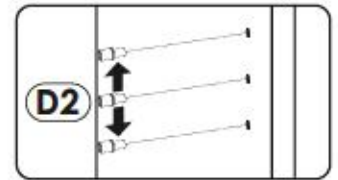
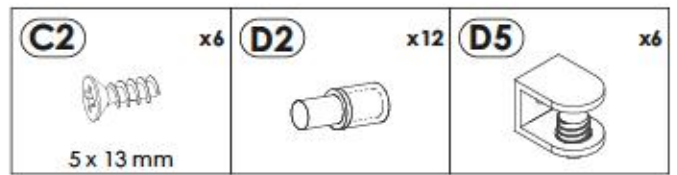
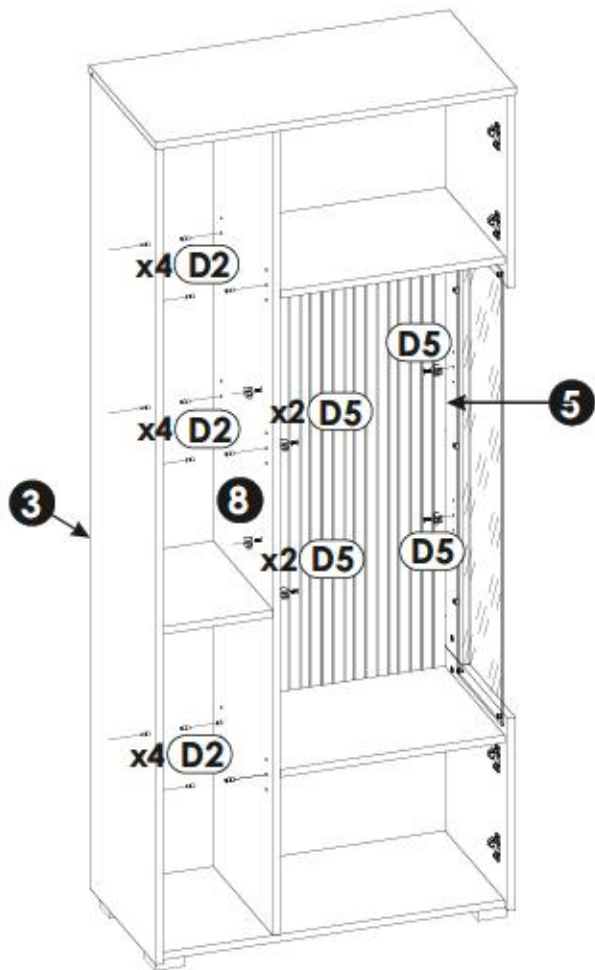

24▶

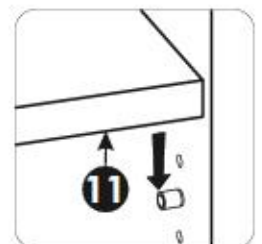
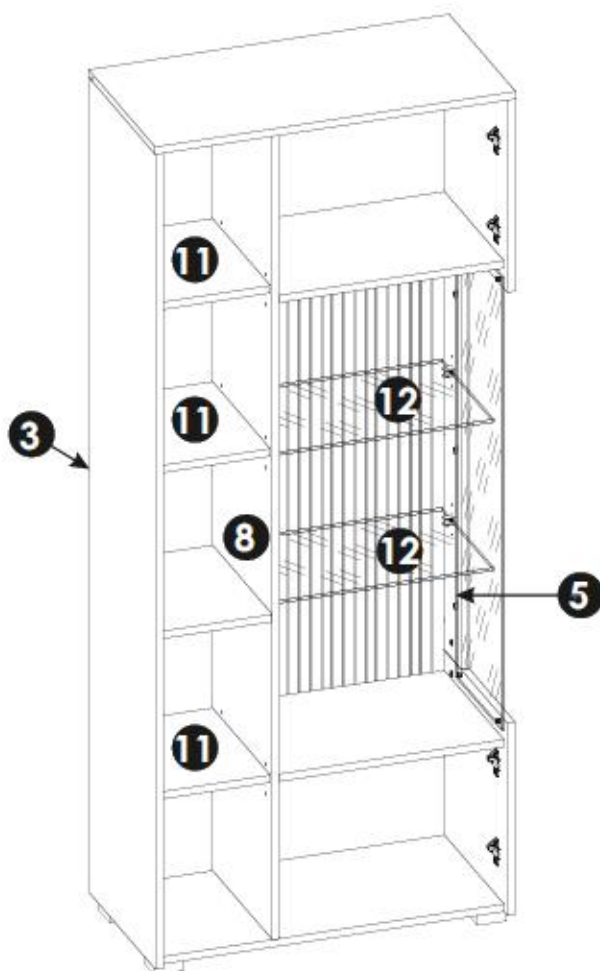

25▶

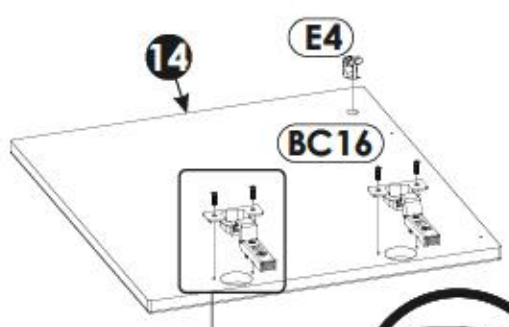

- C2** x4
5 x 13 mm
- BC16** x2
- E4** x1
12 x 10 mm

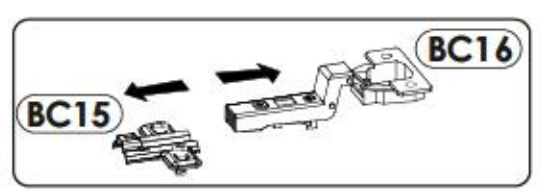
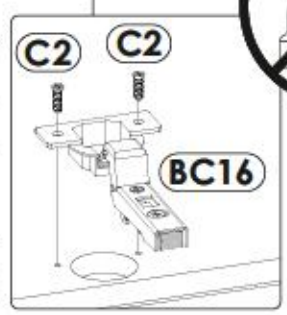
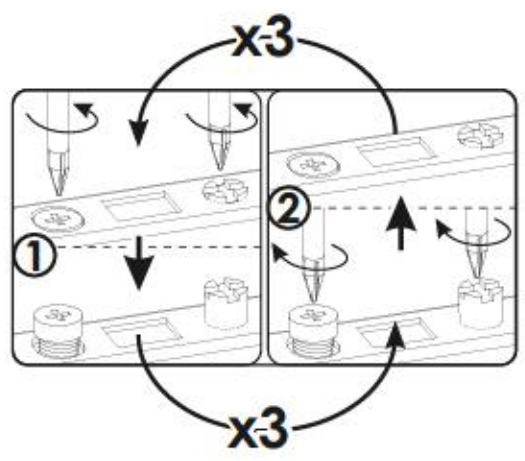

26▶



- E4** x2
12 x 10 mm

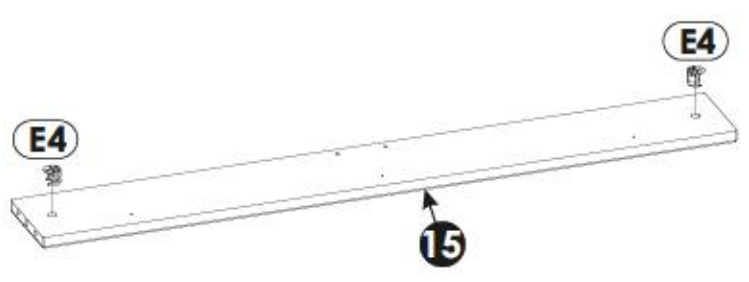

27▶

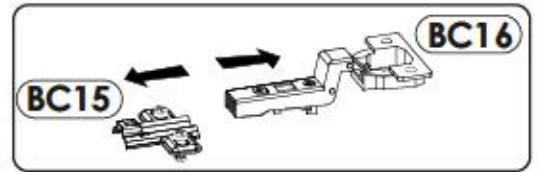
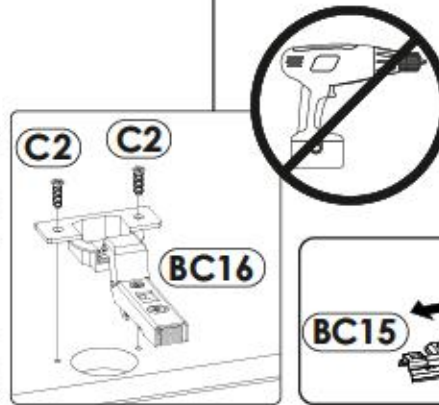
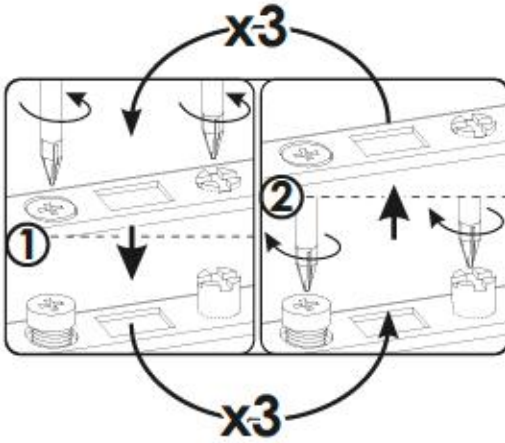
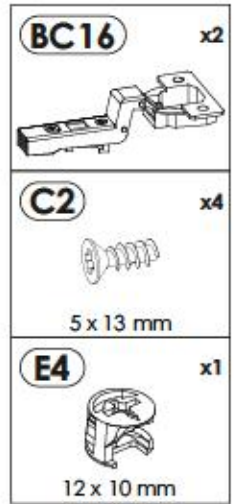
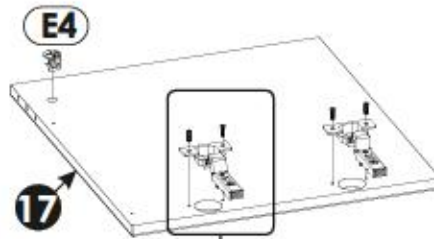

28▶

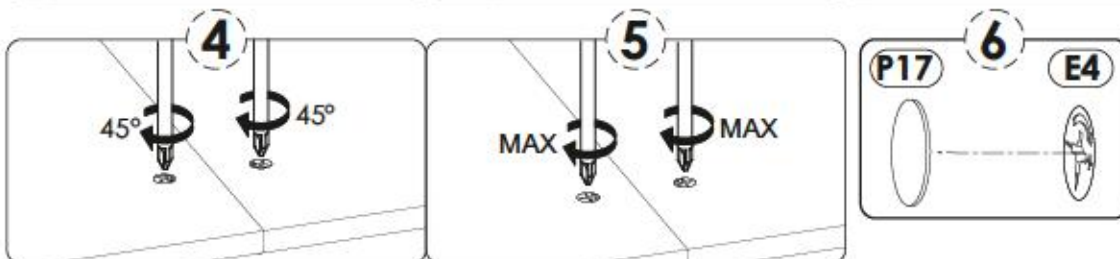
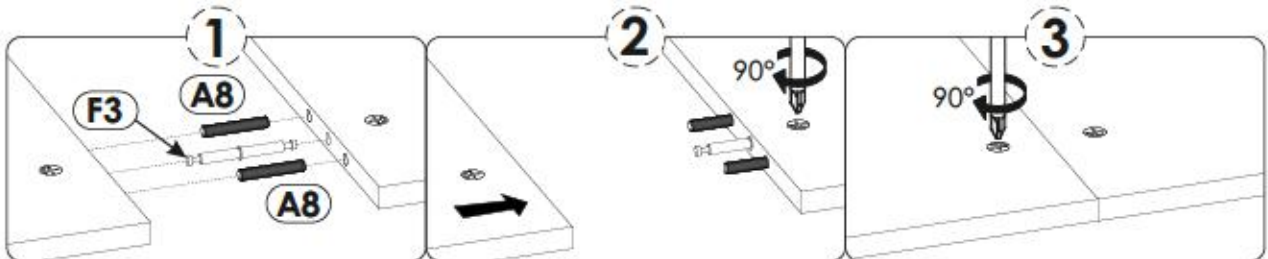
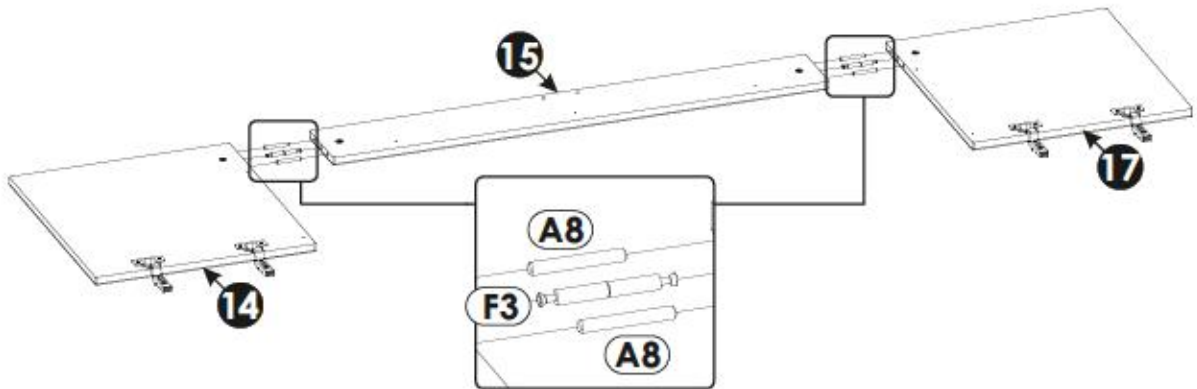
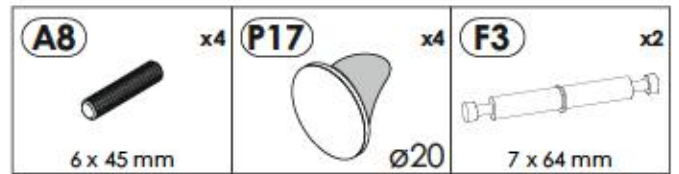
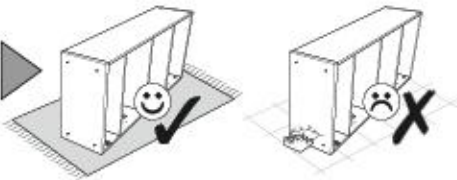

29 ▶

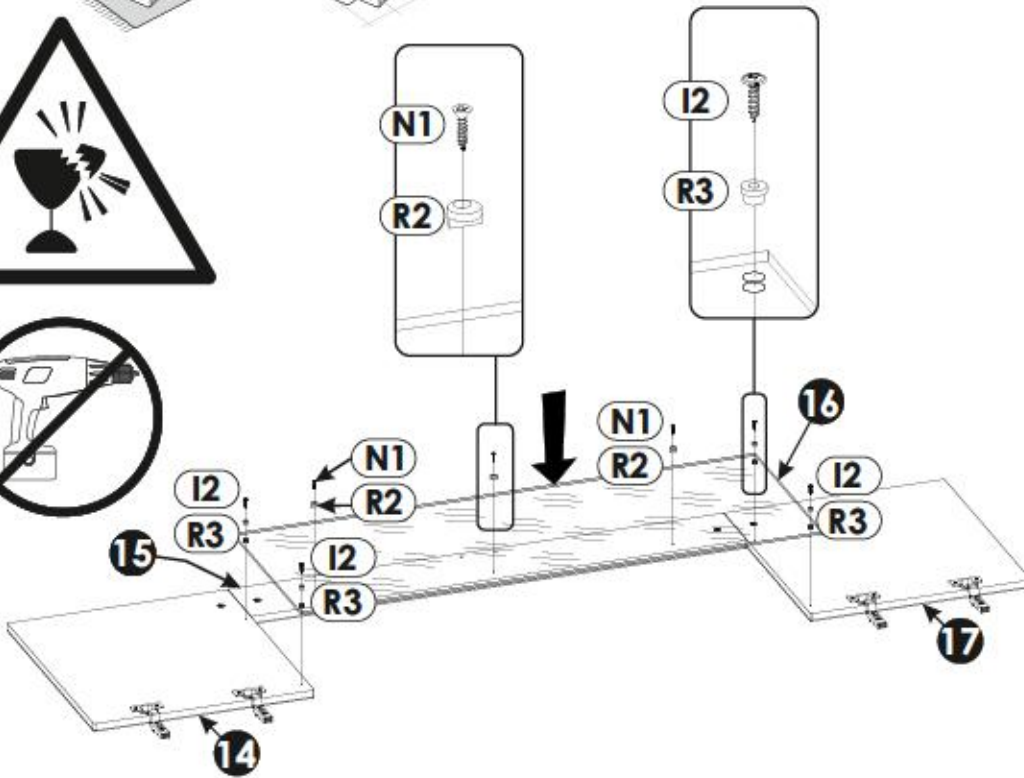
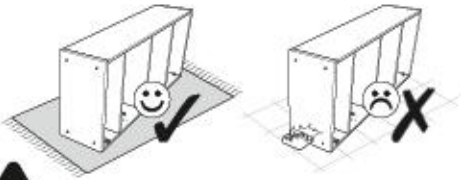

I2	x4
4 x 16 mm	
N1	x3
3 x 16 mm	
R2	x3
R3	x4

30 ▶

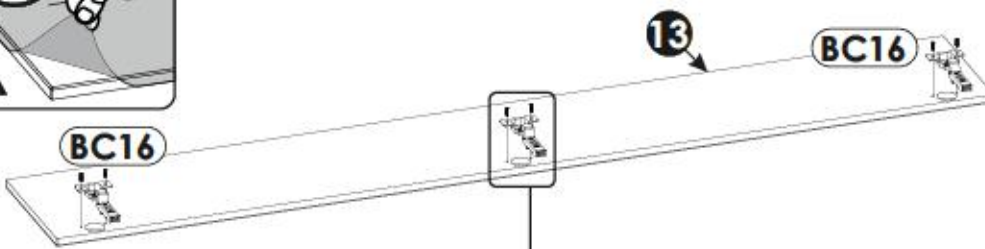

BC16	x3
C2	x6
5 x 13 mm	

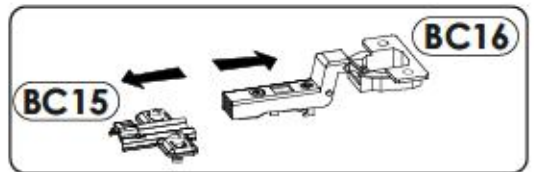
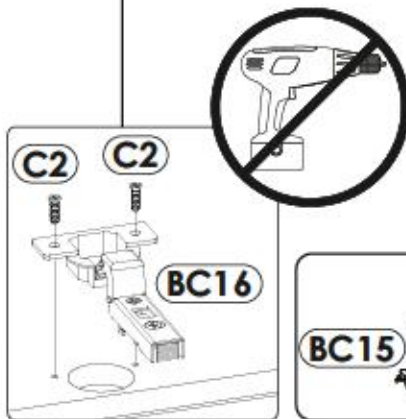
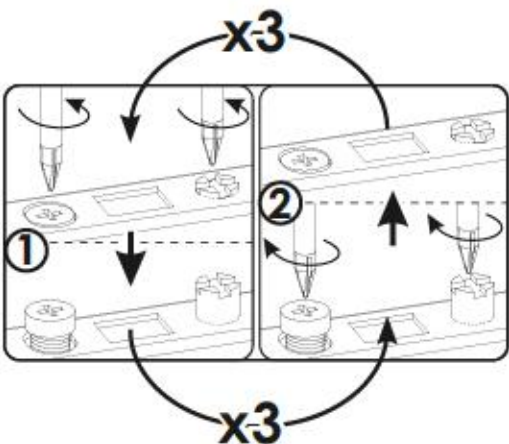

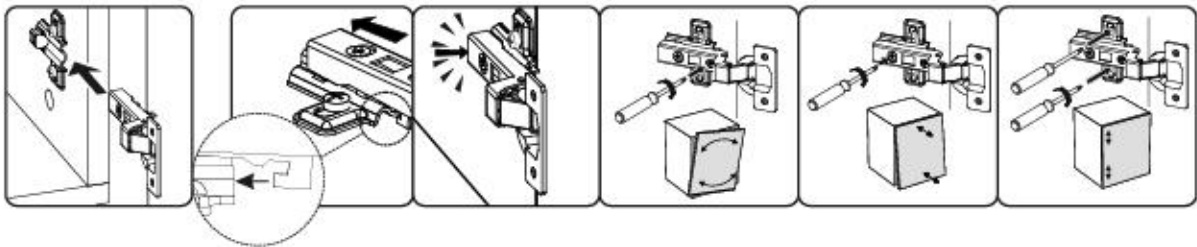
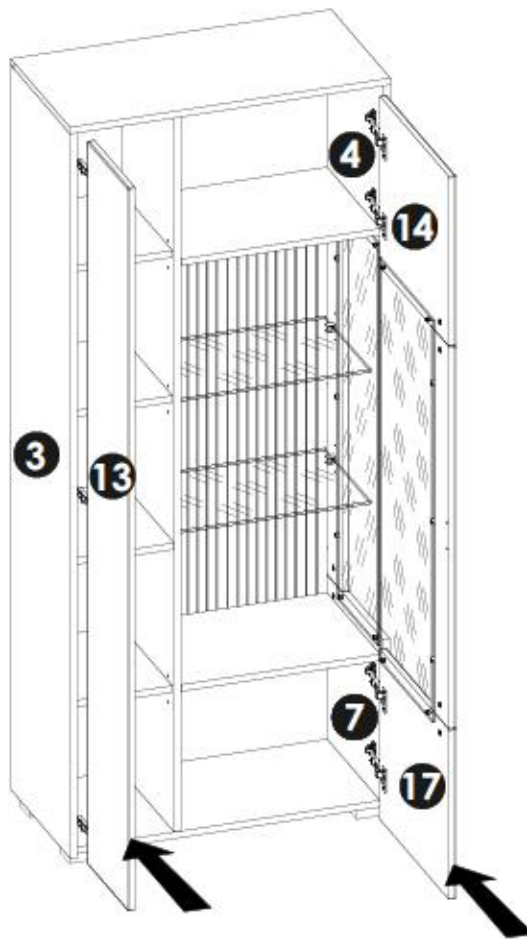

31▶

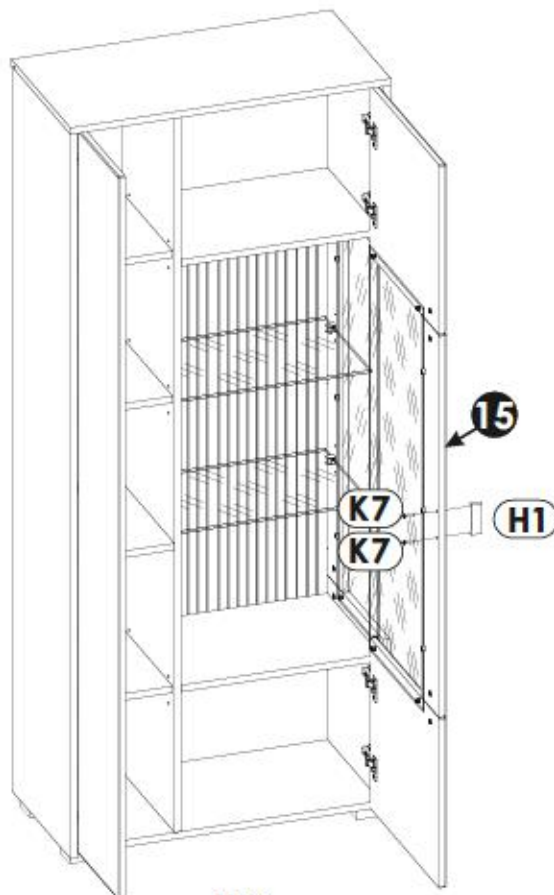

32▶



H1	x1
	
L - 75 mm	
K7	x2
	
4 x 22 mm	

33 ▶



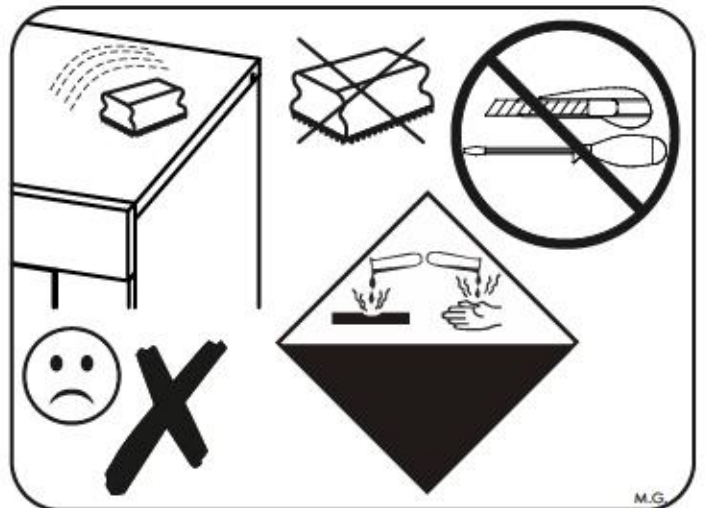
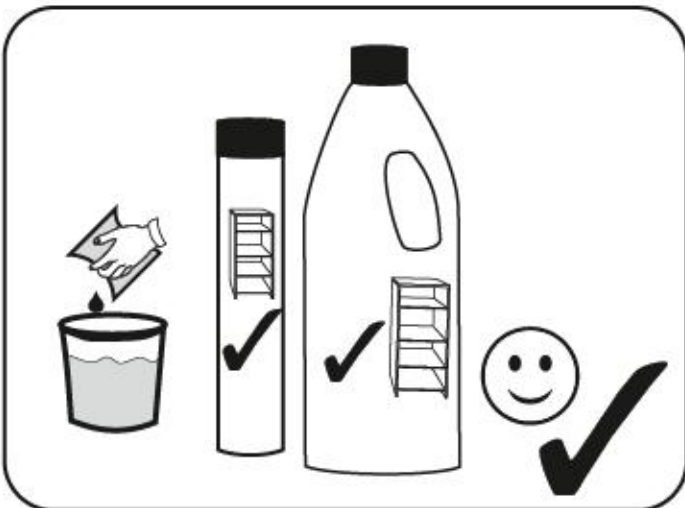
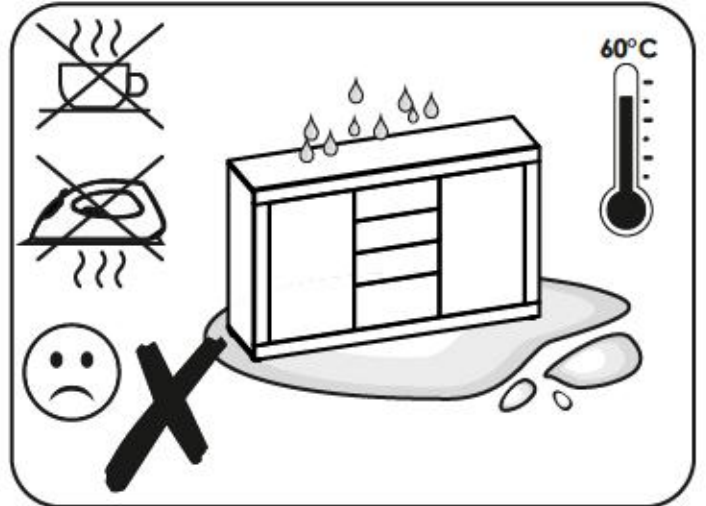
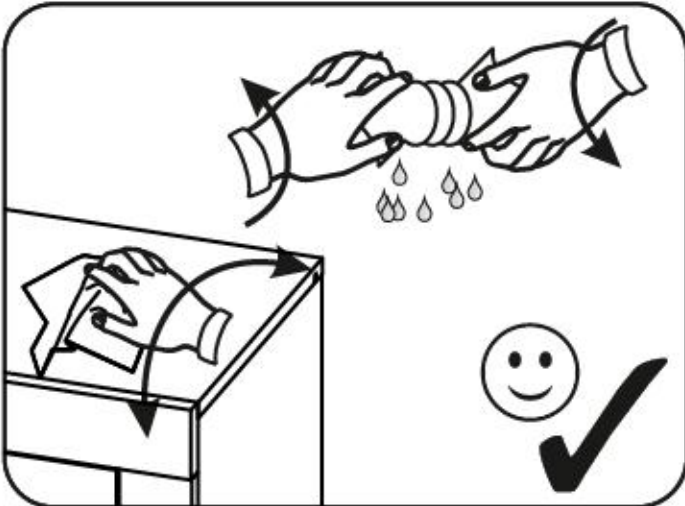
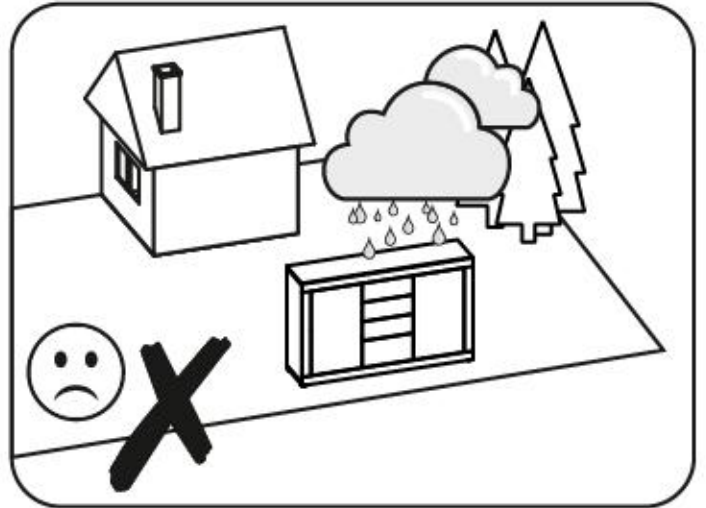
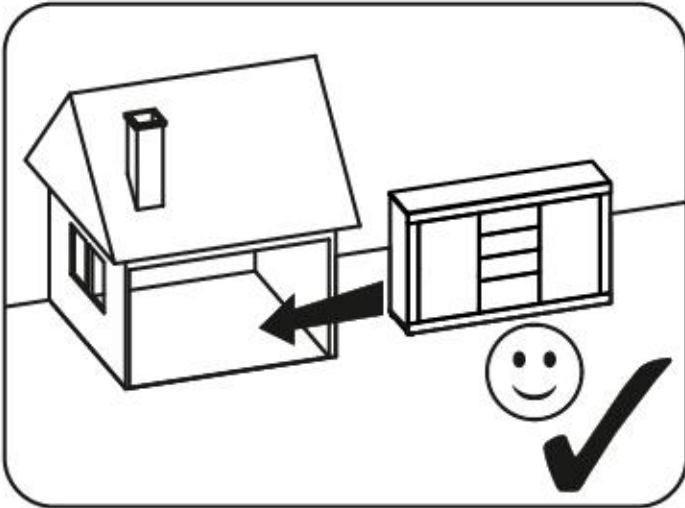

3WSEHU26/3WSYHU26

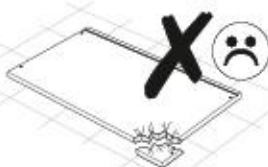
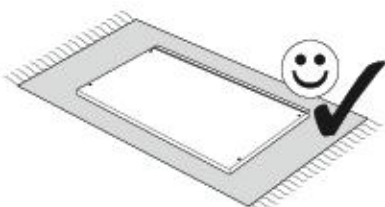
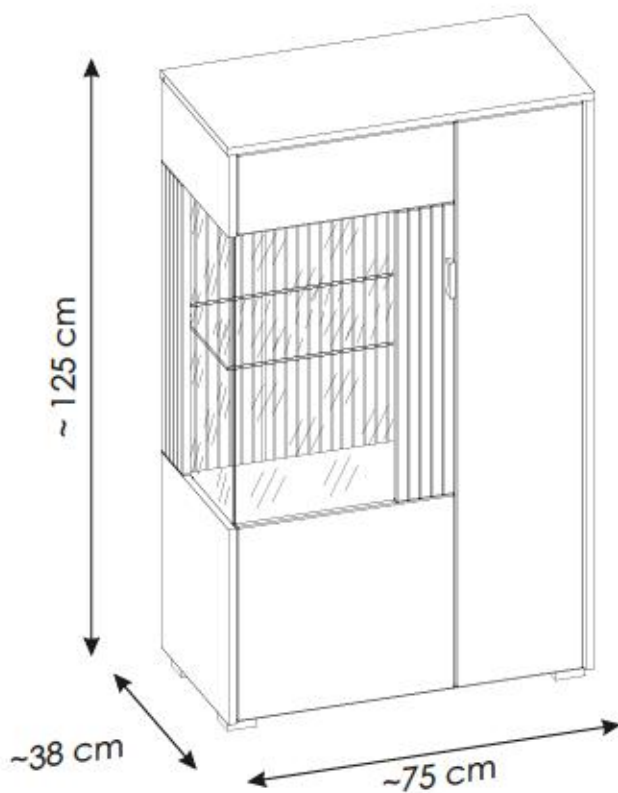

ملاحظة!

يجب تثبيت الأثاث بإحكام إلى الحائط أو الجدار لتجنب خطر إنقلابه. لا تحتوي العلبه على مسامير التثبيت، إذ إنه ينبغي إستعمال المسامير المخصصة لنوعية الحائط أو الجدار. اختر المسامير التي تناسب جدارك.

E.

¡ATENCIÓN! El mueble debe ser fijado permanentemente a la pared para evitar el riesgo relacionado con el vuelco del mueble. En el paquete no hay tornillos de fijación, ya que se debe elegir el tipo de fijación adecuado para el tipo de pared. Elija el apropiado para su tipo de pared.

CN.

注意！本家具需要固定在墙上以免倒塌。箱子里没有安装螺钉。因为安装方式需要根据墙的类型调整。请按照您的墙类型选择合适的安装方式。

SLO.

POZOR! Pohišivo trajno pritrđite na steno, da preprečite tveganje, da se prevrne. V paketu ni pritrđilnih vijakov, saj je treba način pritrđitve ustrezno izbrati glede na vrsto stene. Izberite način, ki je ustrezen za vašo steno.

HU.

FIGYELEM! Rögzítse a bútorokat a falhoz, hogy elkerülje a bútor felborulásának kockázatát. A készletben nem találhatóak rögzítőcsavarok, mivel a rögzítés típusa a fal típusától függ. Válassza ki a fal típusának megfelelő kötőelemeket.

NL.

OPMERKING! De meubelen moeten permanent aan de muur worden bevestigd om te voorkomen dat de meubelen kantelen. Er zitten geen bevestigingsschroeven in het pakket, omdat het type bevestiging moet worden gekozen op basis van het type muur. Kies de juiste voor uw type muur.

EN.

WARNING! To prevent this furniture from tripping over, fix it to the wall permanently. Fixing devices are not included since different wall materials require different types of fixing devices. Please make sure you chose the correct ones for your type of wall.

SK.

POZORI Nábytok musí byť trvalo pripevnený k stene tak, aby sa zamedzilo riziku prevrátenia. Balík neobsahuje upevňovacie skrutky, pretože typ upevnenia je treba vybrať podľa typu steny. Vyberte typ vhodný pre Vašu stenu.

CZ.

POZOR! Nábytek je nutné pevně připevnit ke zdi, abychom se vyhnuli riziku spojenému s jeho převrnutím. Součástí balení nejsou připevňovací šrouby, protože způsoby připevnění je nutné zvolit podle druhu stěny. Vyberte správný pro Váš typ stěny.

RU.

ПРИМЕЧАНИЕ! Эту мебель необходимо всегда прикреплять к стене, чтобы избежать рисков, связанных с переворотом мебели. В пакете нет крепежных винтов, потому что тип крепления должен быть выбран в соответствии с типом стены. Выберите, пожалуйста, правильные винты к вашей стене.

RO.

ATENȚIE! Mobila trebuie ancorată permanent în perete pentru a evita riscul de răsturnare a mobilei. În pachet nu sunt incluse șuruburile de fixare, deoarece tipul de ancoraj trebuie ales în funcție de tipul de perete. Alegeți șuruburile potrivite pentru tipul Dvs. de perete.

TR.

DIKKATİ! Devrİlme riskini önlemek için mobilya duvara sabİllenmelidir. Sabİtleme civataları pakete dahil deđİl, çünkü sabİtleme tertibatının tipi, duvara tipine uygun olarak seçİlmelidir. Onu duvannızın tipine göre seçiniz.

PL.

UWAGA! Mebel należy trwale zamocować do ściany, aby uniknąć ryzyka związanego z przewróceniem się mebla. W paczce nie ma śrub mocujących, ponieważ rodzaj mocowania należy odpowiednio dobrać do rodzaju ściany. Dobierz właściwe do Twojego rodzaju ściany.

D.

ACHTUNG! Um alle mit dem Umkippen des Möbels verbundenen Risiken auszuschließen, muss das Möbel fest an der Wand verankert werden. Beschläge für die Wandbefestigung sind nicht beige packt, da diese von der jeweiligen Wandbeschaffenheit abhängig sind. Bitte solche Befestigungsschläge wählen, die für die heimischen Wände geeignet sind.

FR.

ATTENTION! Ce meuble doit être fixé en permanence au mur pour éviter les risques de chute. Les vis de fixation ne sont pas livrées car le type de fixation doit être choisi en fonction du type de mur. Sélectionnez les fixations adaptées au mur.

I.

ATTENZIONE! Il mobile deve essere permanentemente fissato alla parete per evitare i rischi derivanti da un ribaltamento del mobile. La confezione non include le viti di fissaggio, in quanto il tipo di fissaggio deve essere scelto in base al tipo di parete. Utilizzare viti appropriate in base al materiale della parete.

HR.

NAPOMENA! Namještaj mora biti trajno pričvršćen za zid, kako bi se izbjegao rizik od njegovog prevrtanja. U paketu nema vijaka za pričvršćivanje, jer se vrsta montaže mora prilagoditi vrsti zida. Odaberite pravu vrstu prema Vašoj vrsti zida.

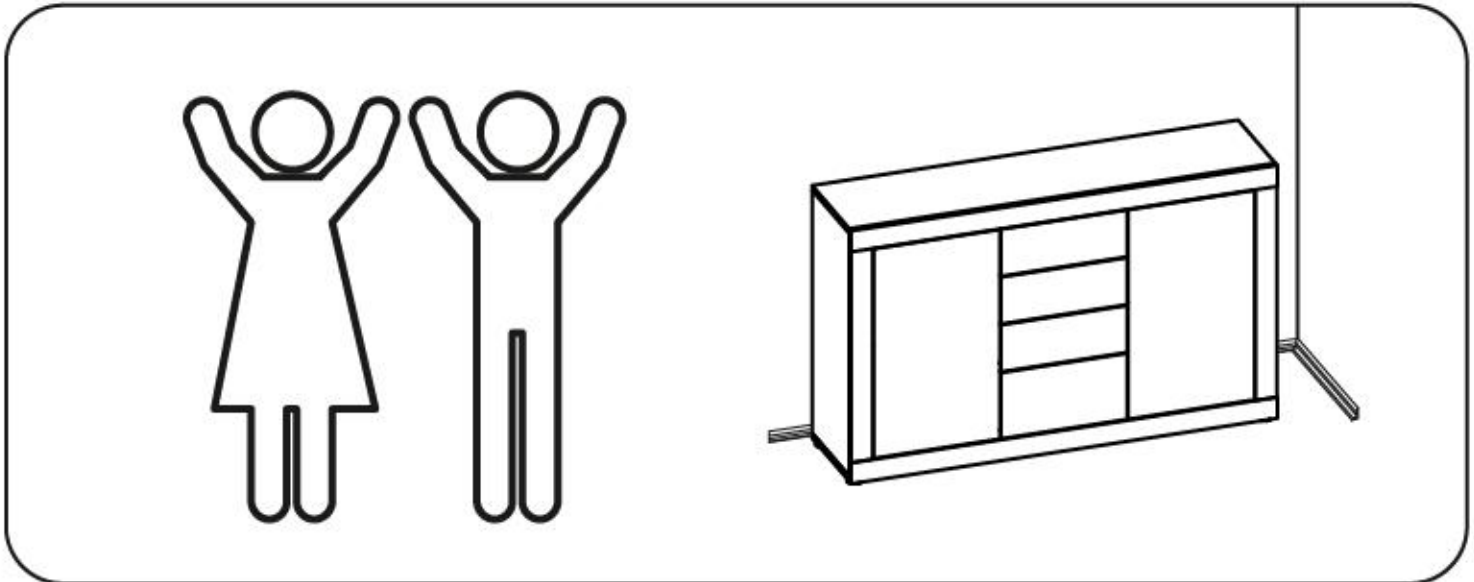
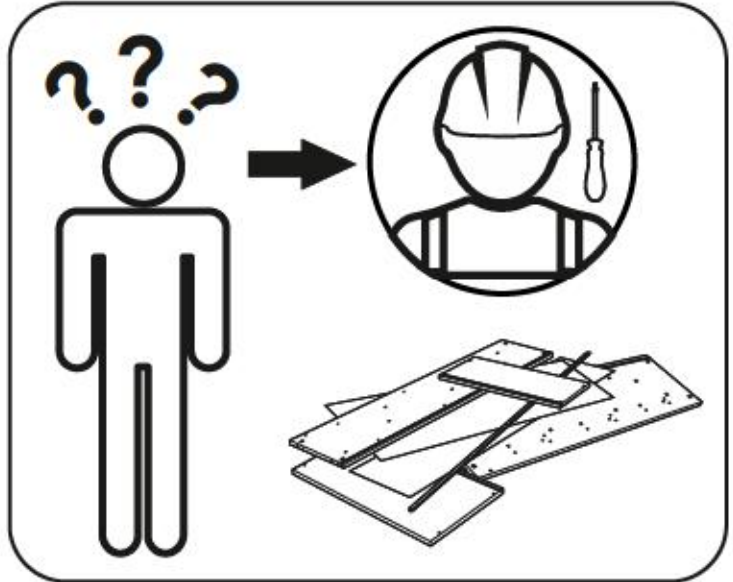
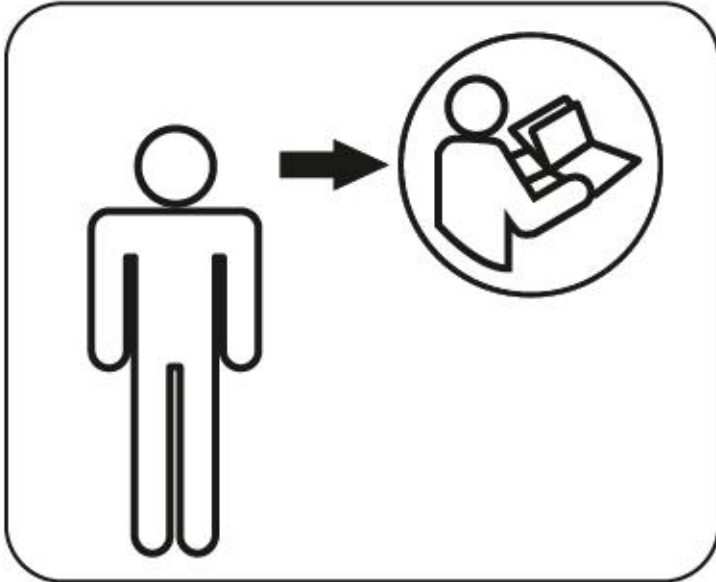
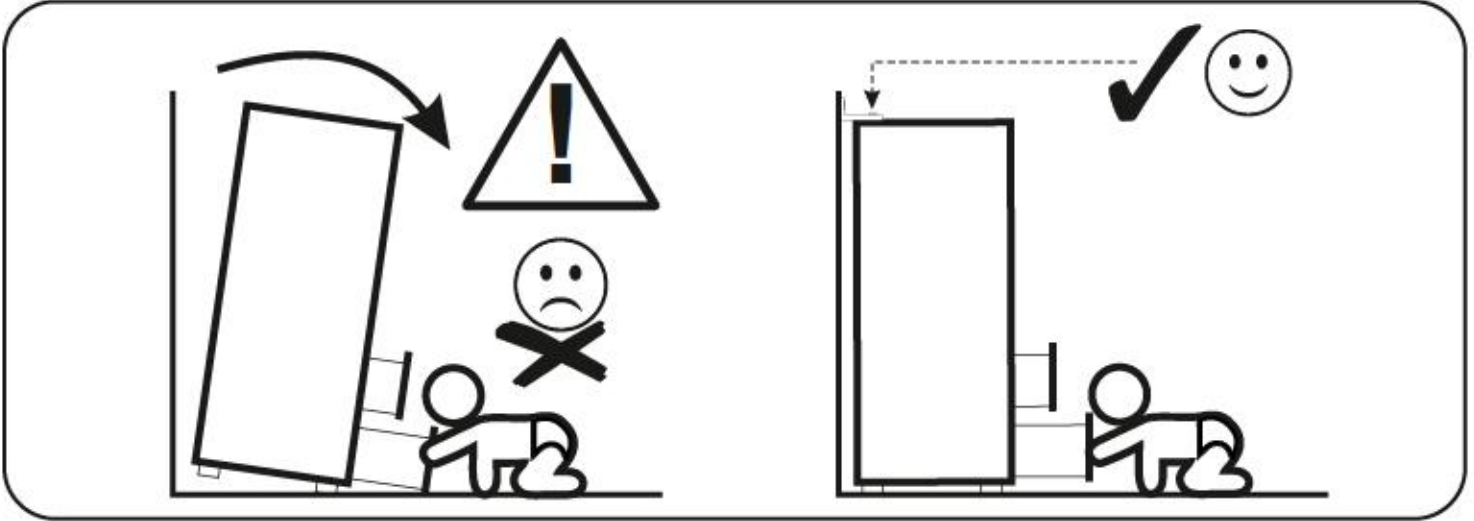
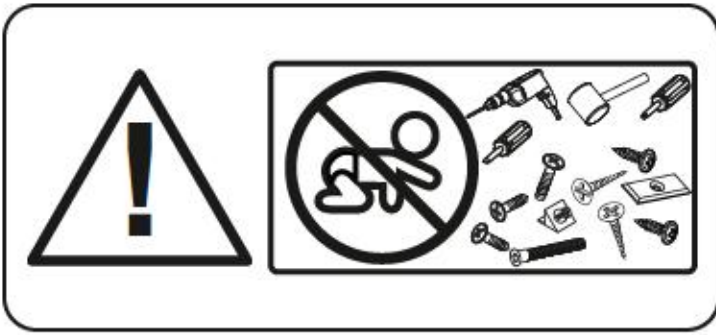



version A

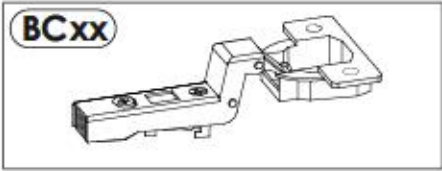

version B

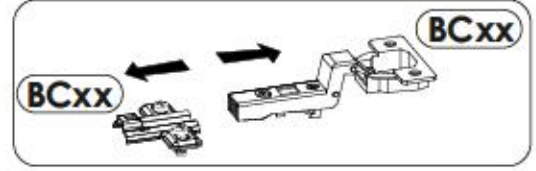
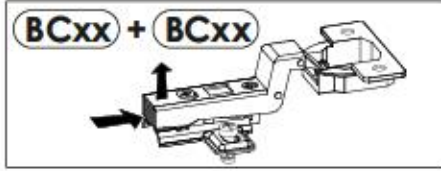

3WSEHU26/3WSYHU26

MM

260

250

240

230

220

210

200

190

180

170

160

150

140

130

120

110

100

90

80

70

60

50























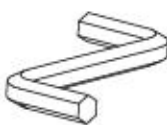

40

30

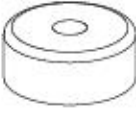
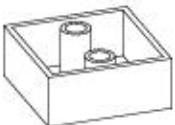
20

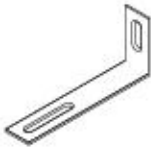
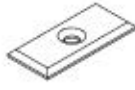
10

0

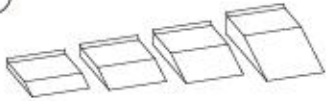
A1 8 x 35 mm x20 	A8 6 x 45 mm x8 	BC15 + BC16 x6 
C2 5 x 13 mm x15 	D2 x8 	D5 x3 
E0 Ø16 x14 	E1 15 x 12 mm x18 	E4 12 x 10 mm x8 
F1 6 x 34 mm x18 	F3 7 x 64 mm x4 	G1 7 x 50 mm x2 
H1 L - 75 mm x1 	I2 4 x 16 mm x10 	I3 3.5 x 22 mm x1 
I13 4 x 30 mm x8 	K7 4 x 22 mm x2 	M x1 
N1 3 x 16 mm x30 	O1 x1 	O6 x4 
P17 x8 ø20 	Q9 x2 	R1 x16 
R2 x4 	R3 x8 	R4 x8 
Z x1 		



3WSEHU26/3WSYHU26

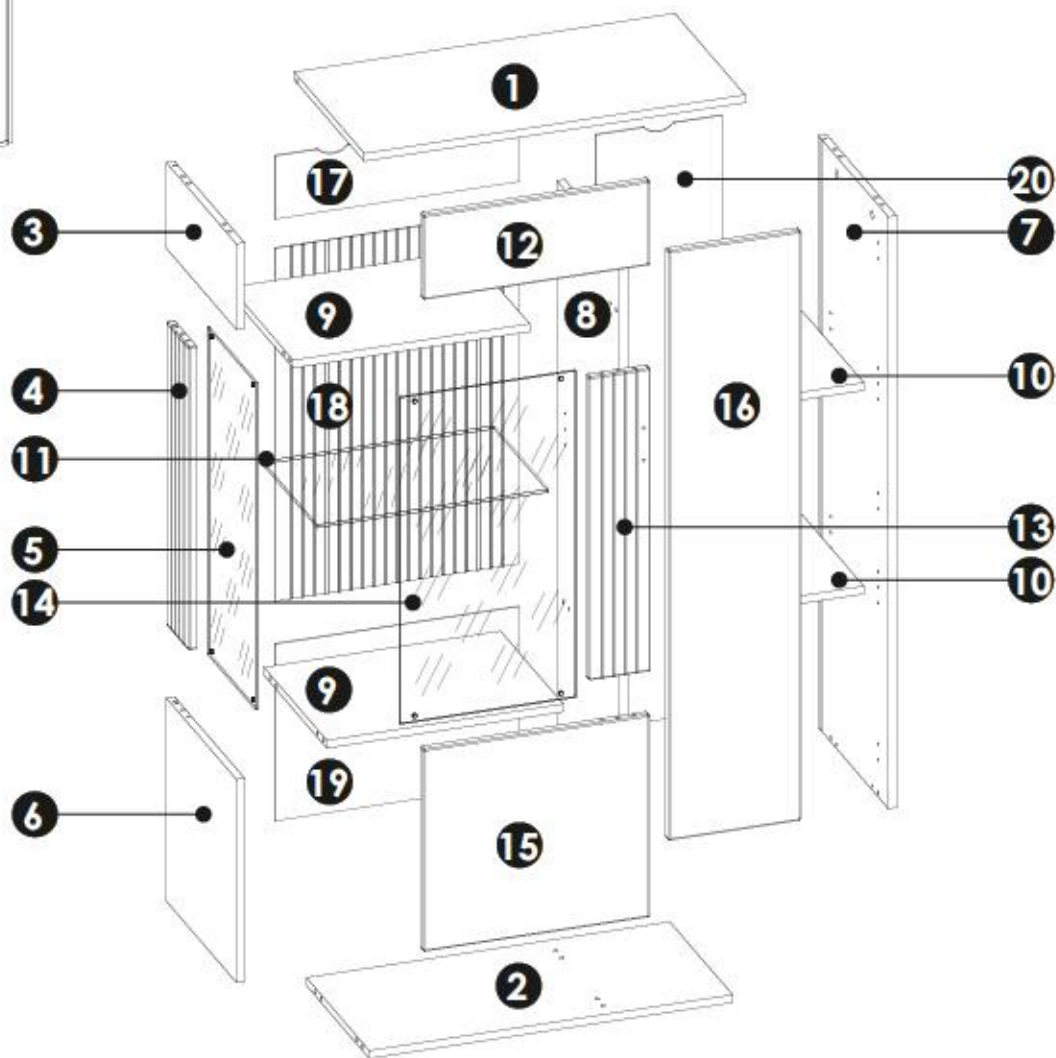

1	750	380	16	x1	1/2
2	716	340	16	x1	1/2
3	175	379	16	x1	1/2
4	619	120	16	x1	1/2
5	667	262	4	x1	2/2
6	415	379	16	x1	1/2
7	1209	379	16	x1	2/2
8	1193	340	16	x1	2/2
9	466	340	16	x2	1/2
10	233	330	16	x2	2/2

11	456	305	6	x1	1/2
12	172	446	16	x1	1/2
13	619	120	16	x1	1/2
14	667	347	4	x1	2/2
15	413	446	16	x1	1/2
16	1204	261	16	x1	2/2
17	129	480	3	x1	1/2
18	721	480	3	x1	1/2
19	361	480	3	x1	2/2
20	1215	248	3	x1	2/2

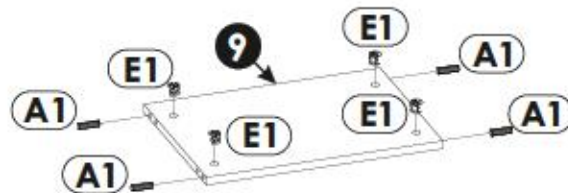
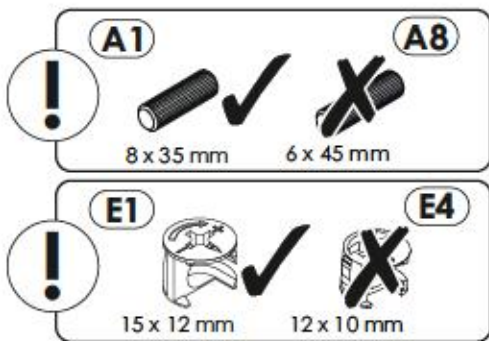
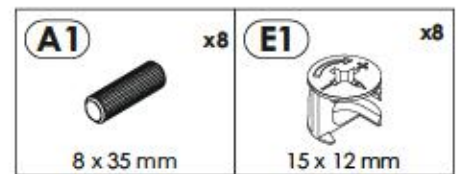
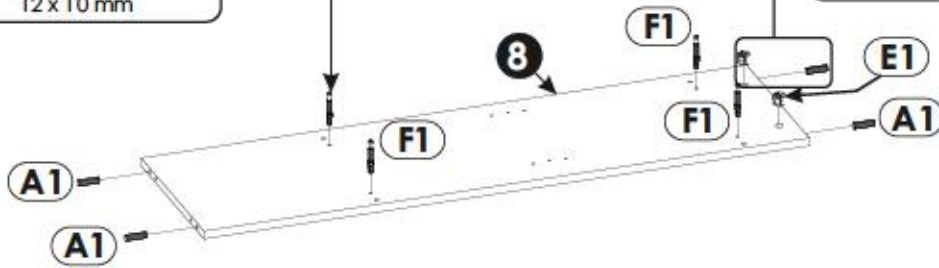
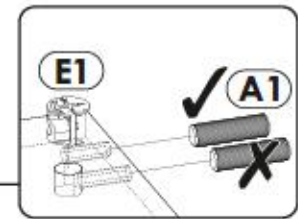
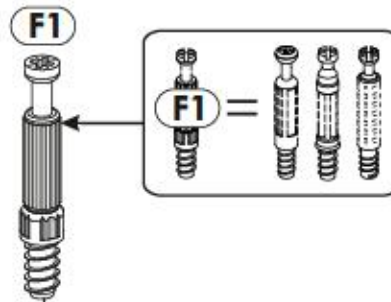
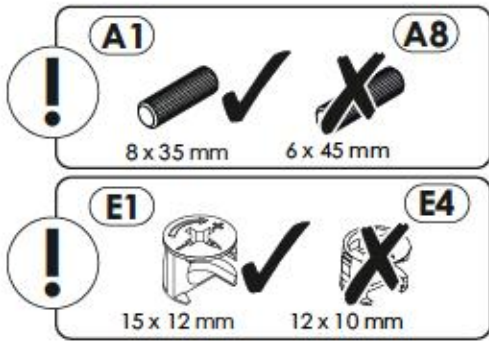
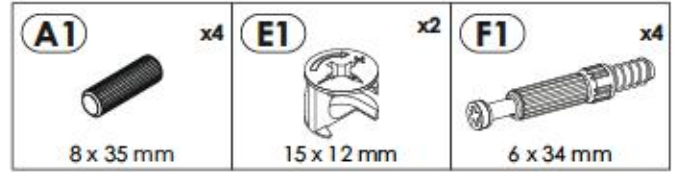
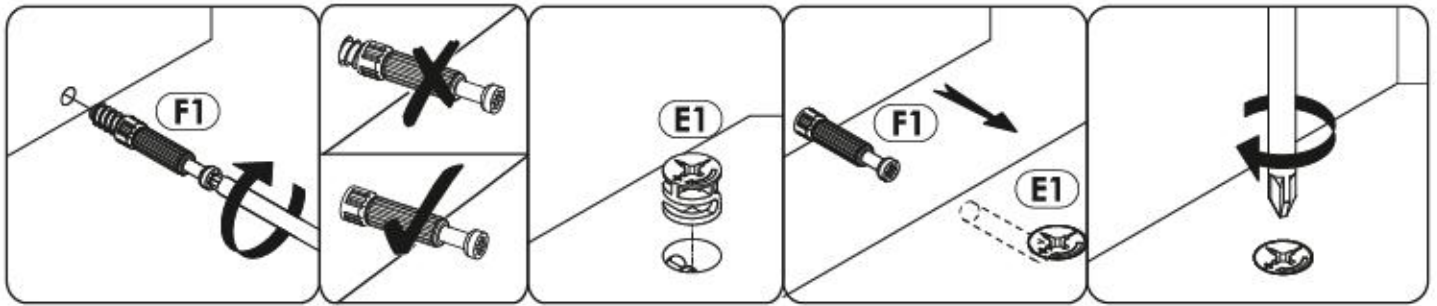

x2

3 ▶

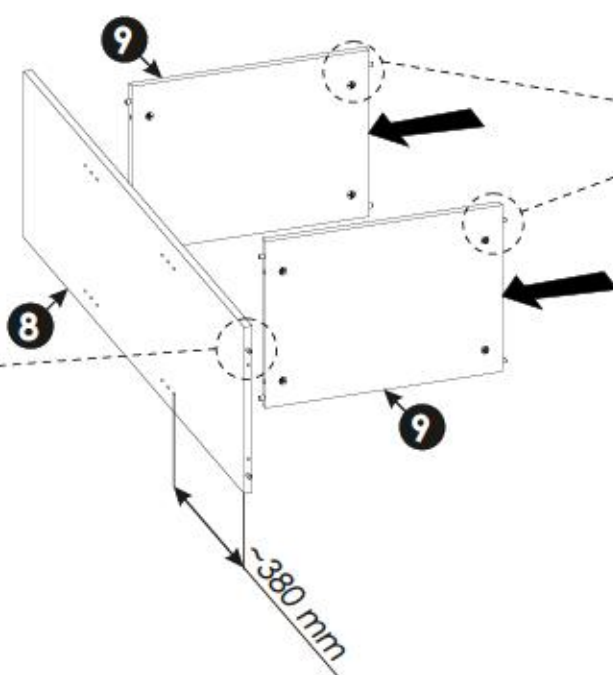
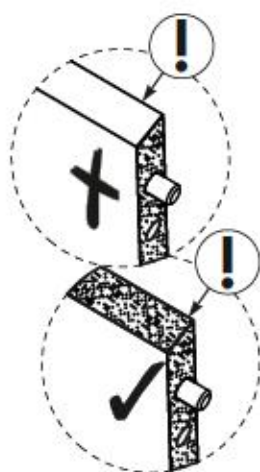
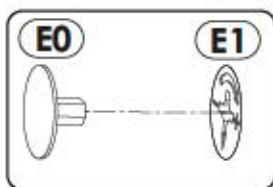
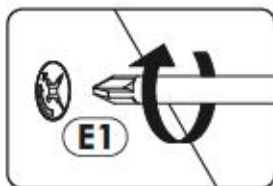
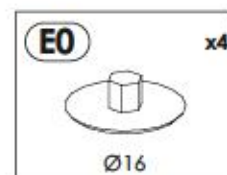
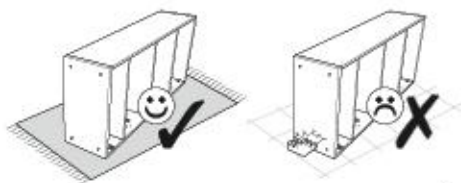

4 ▶

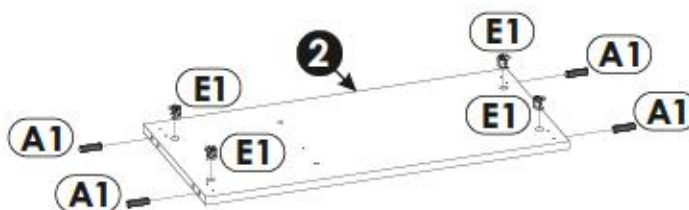

5 ▶

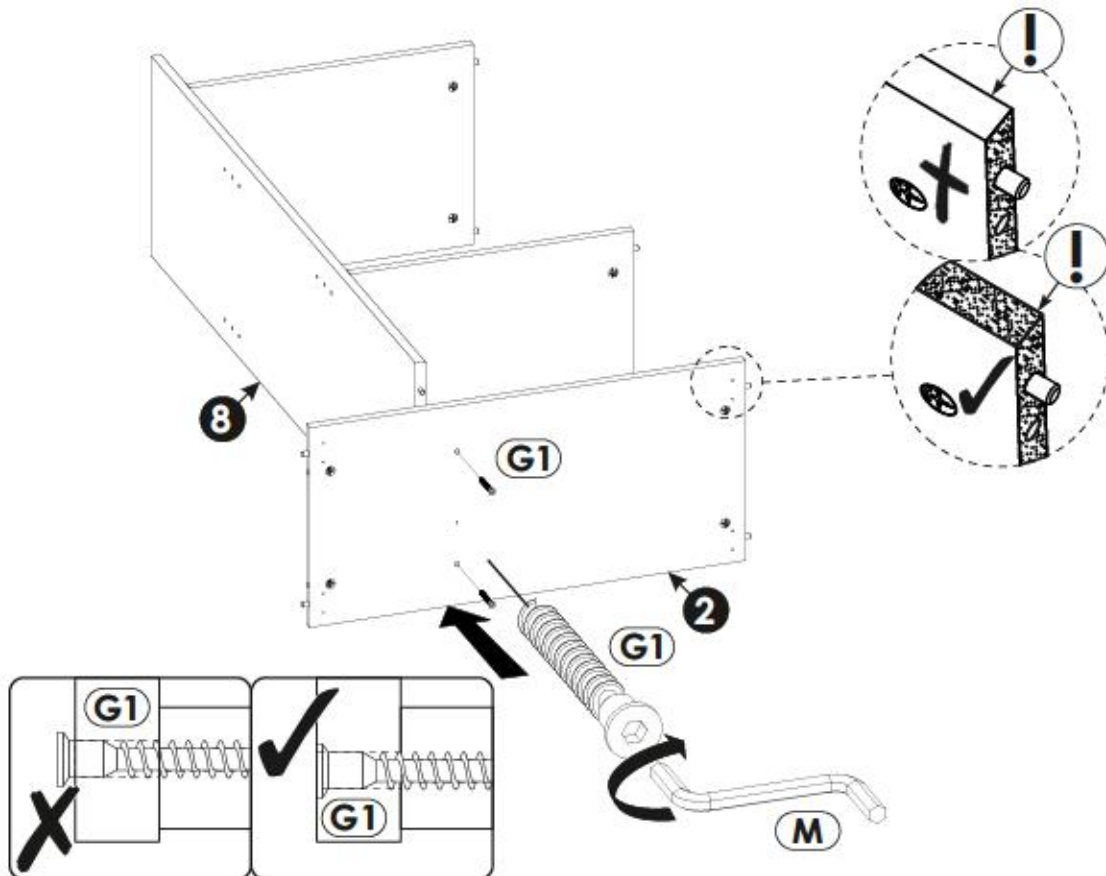
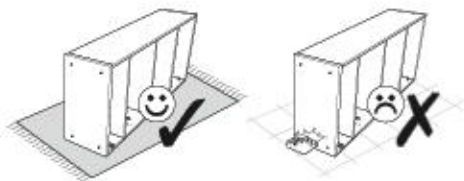

6 ▶

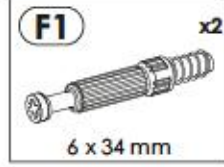
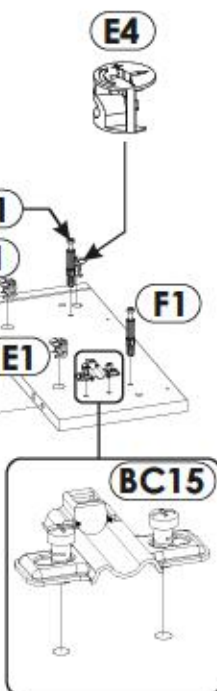
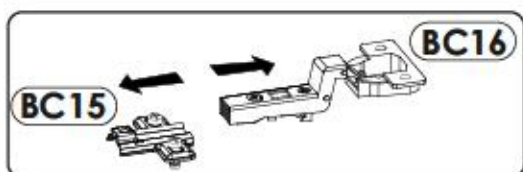

7 ▶

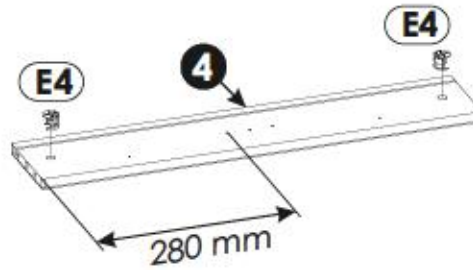
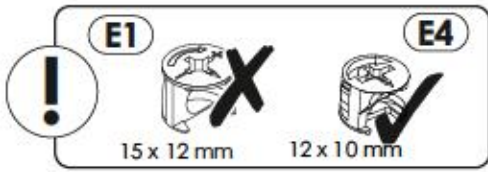
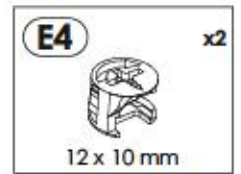

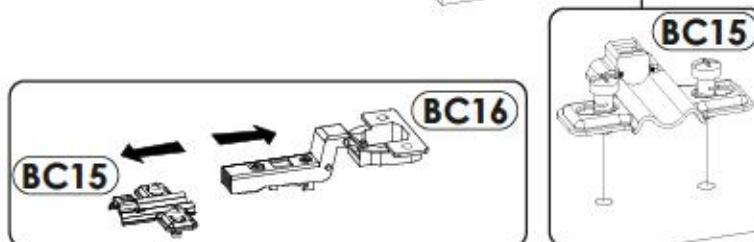
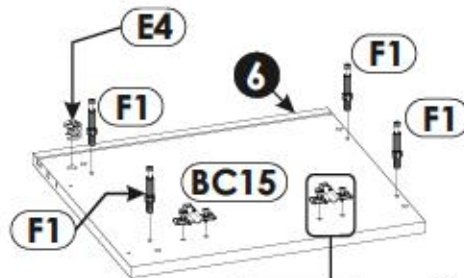
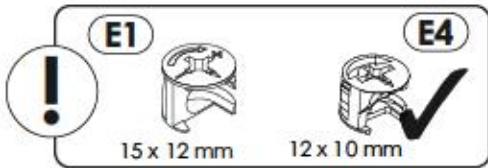
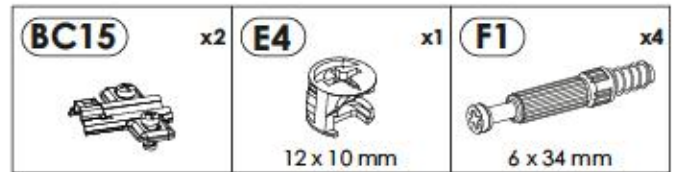

8 ▶

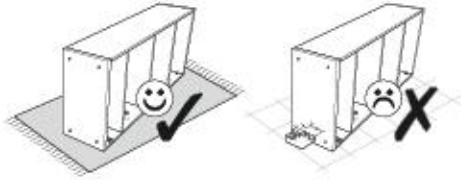

9 ▶



A8  6 x 45 mm	x4	F3  7 x 64 mm	x2	P17  ø20	x4
---	----	---	----	--	----

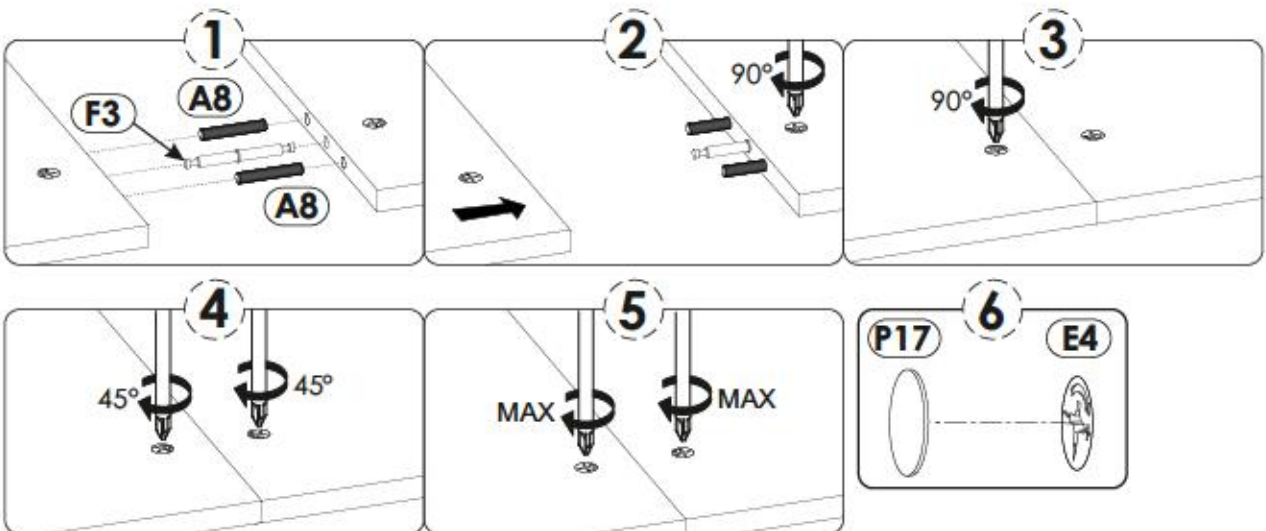
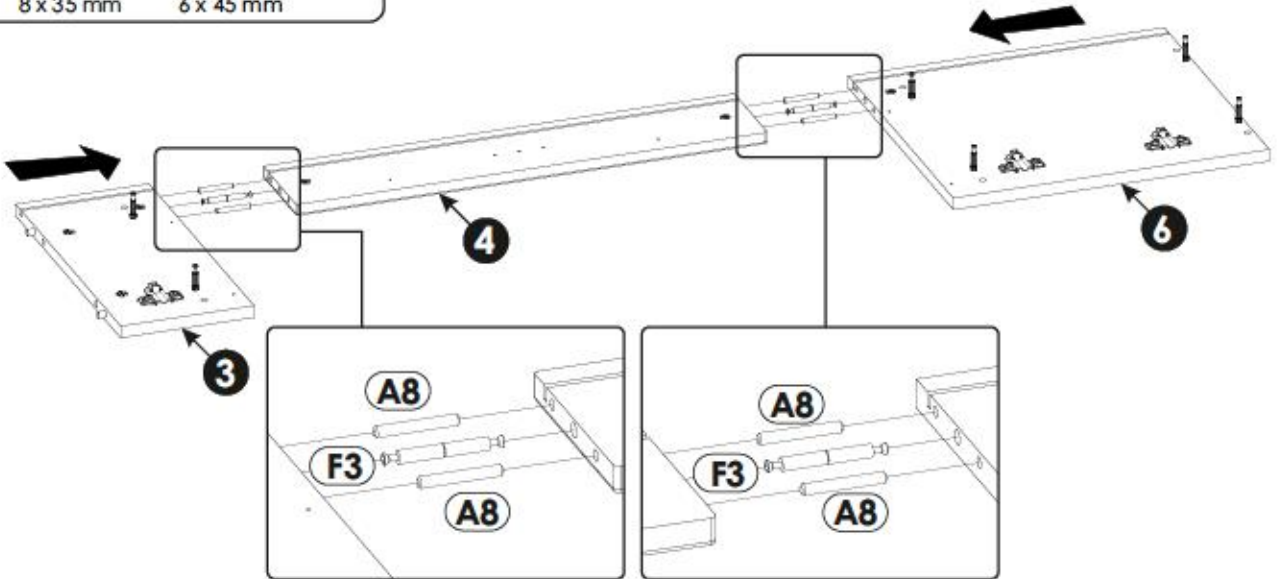
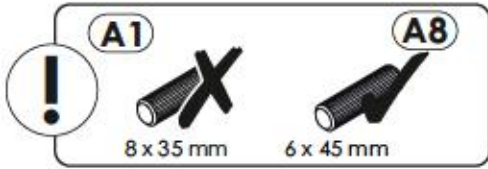

10 ▶

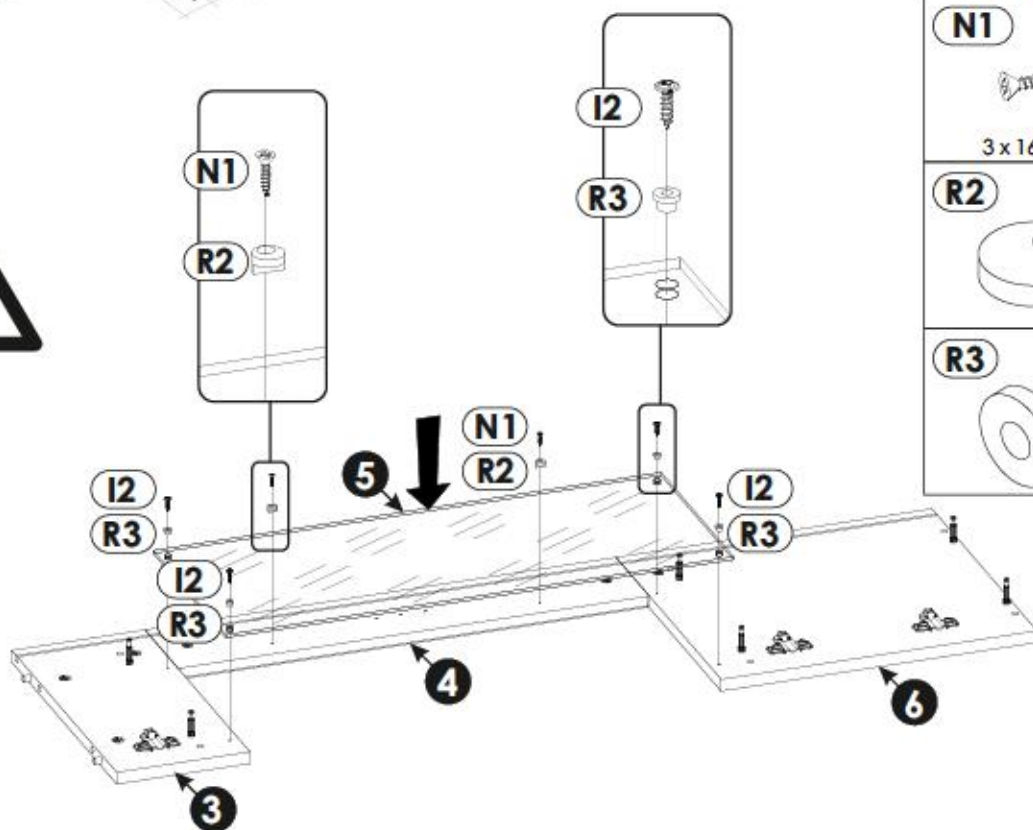
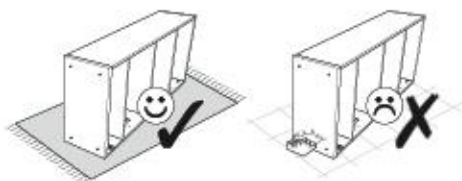

I2	x4
4 x 16 mm	
N1	x2
3 x 16 mm	
R2	x2
R3	x4

11 ▶

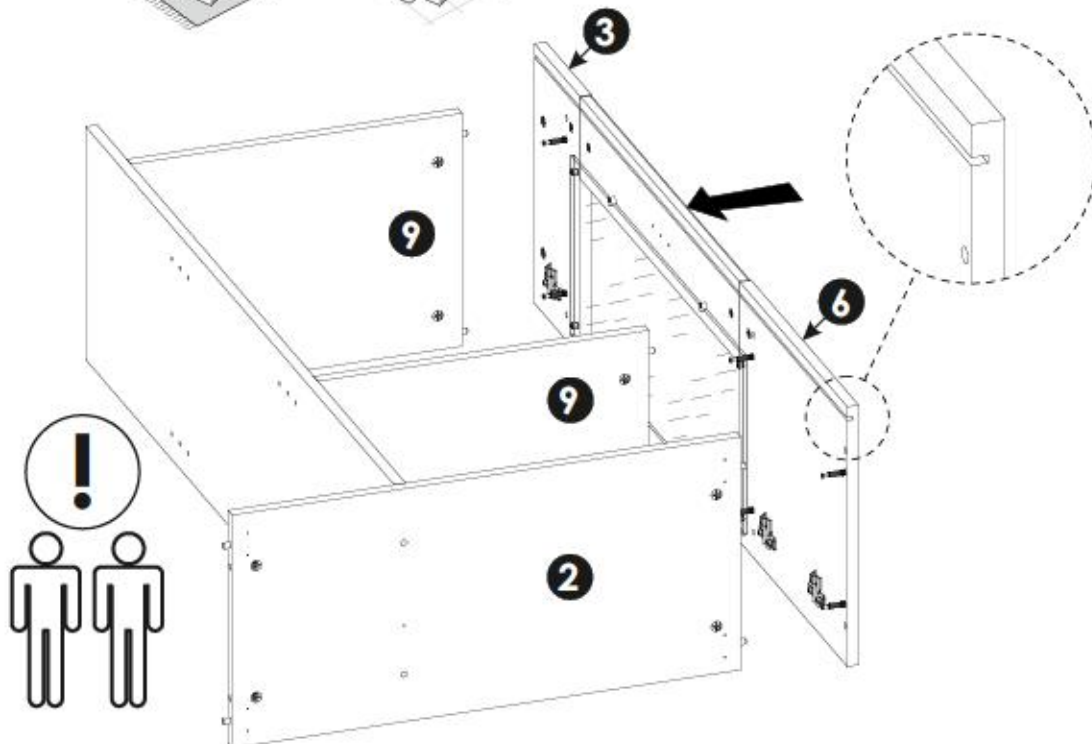
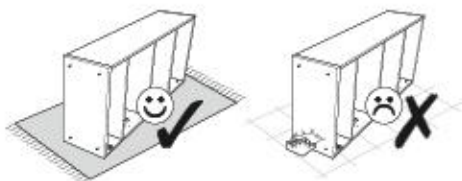

E0	x4
Ø16	

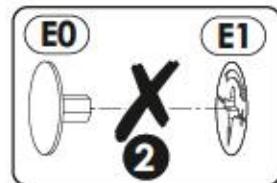
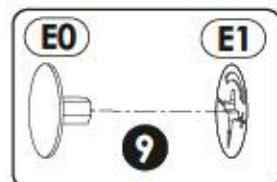
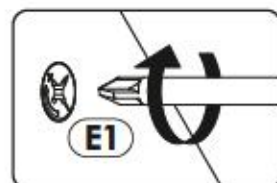

12▶

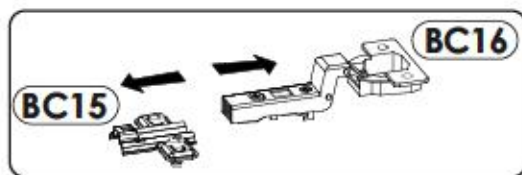
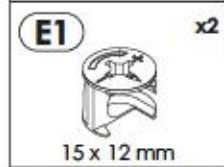
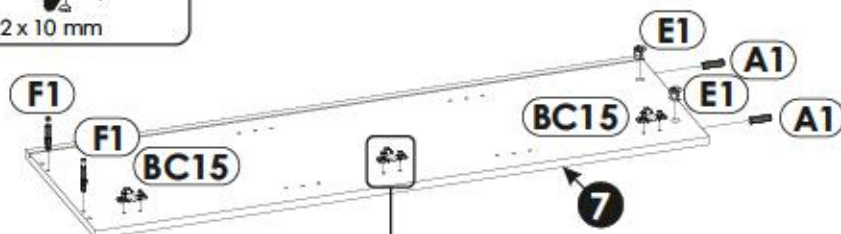
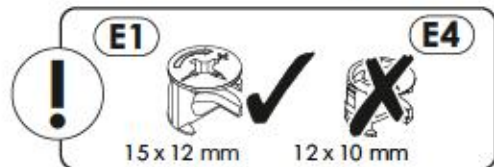

13▶

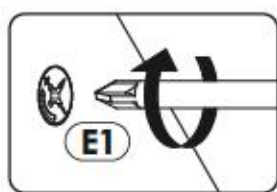
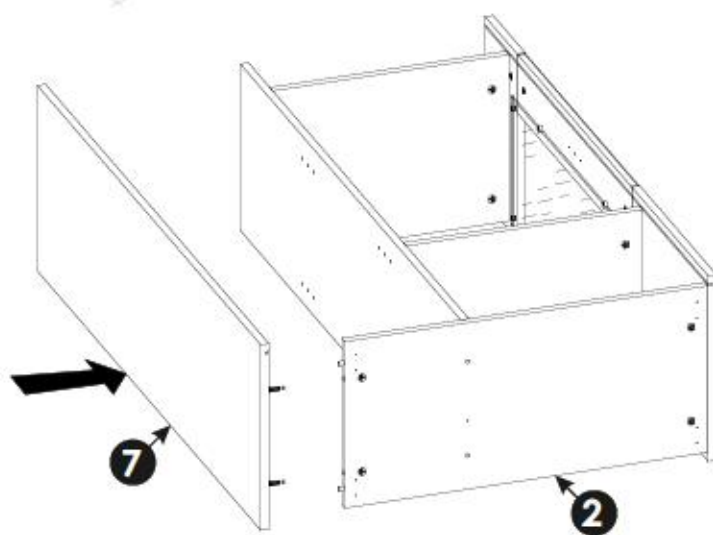
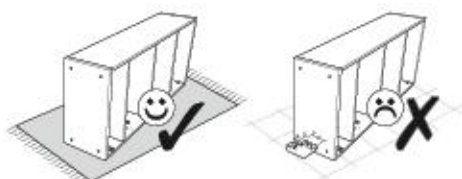

14▶

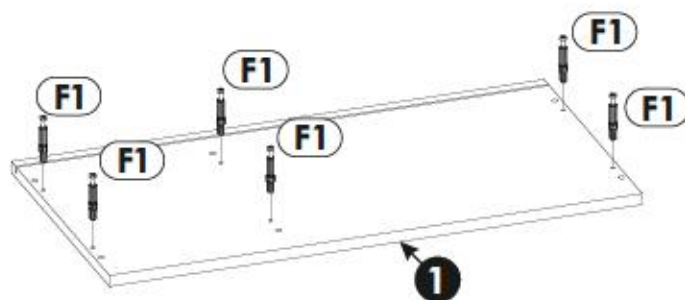
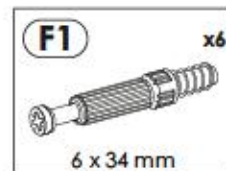

15▶

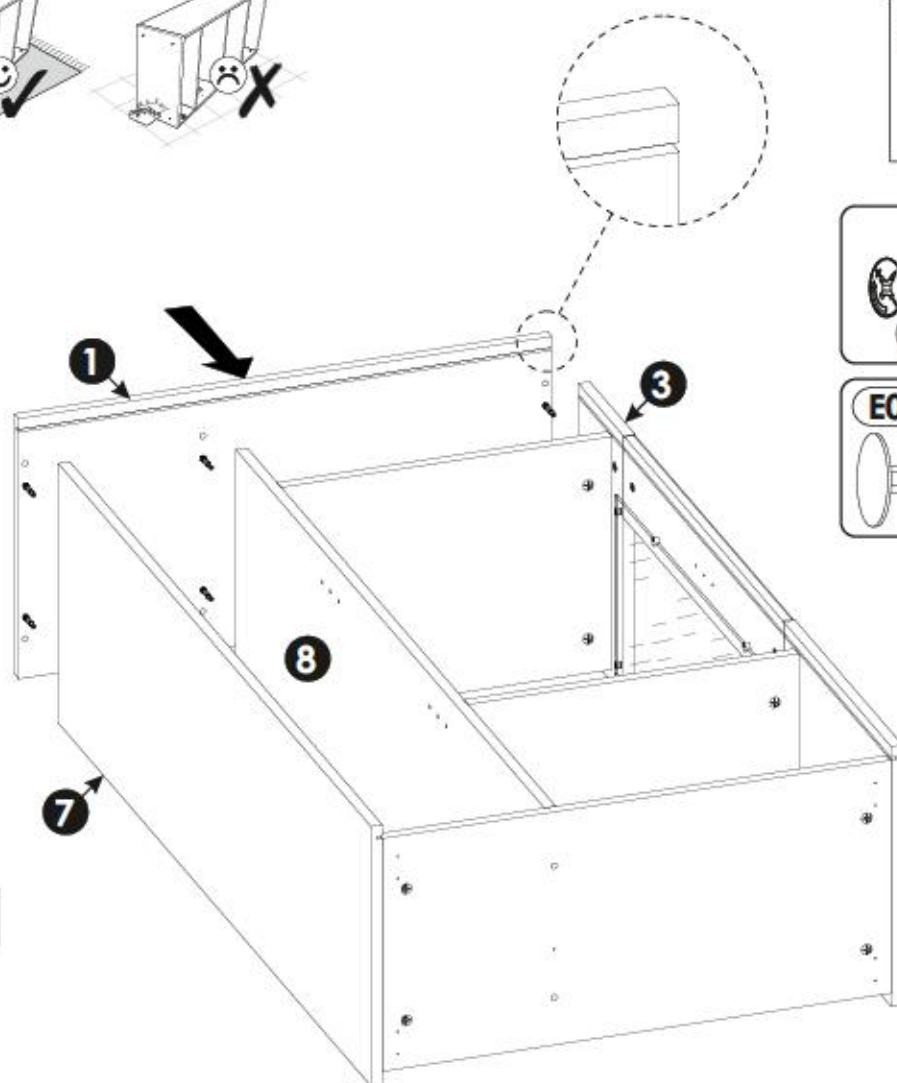
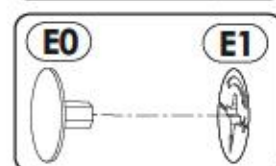
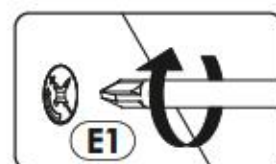
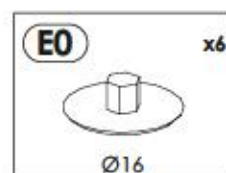
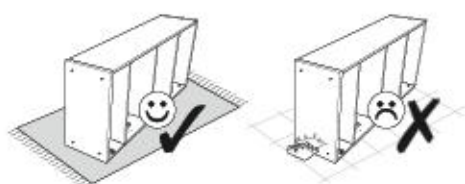

16▶

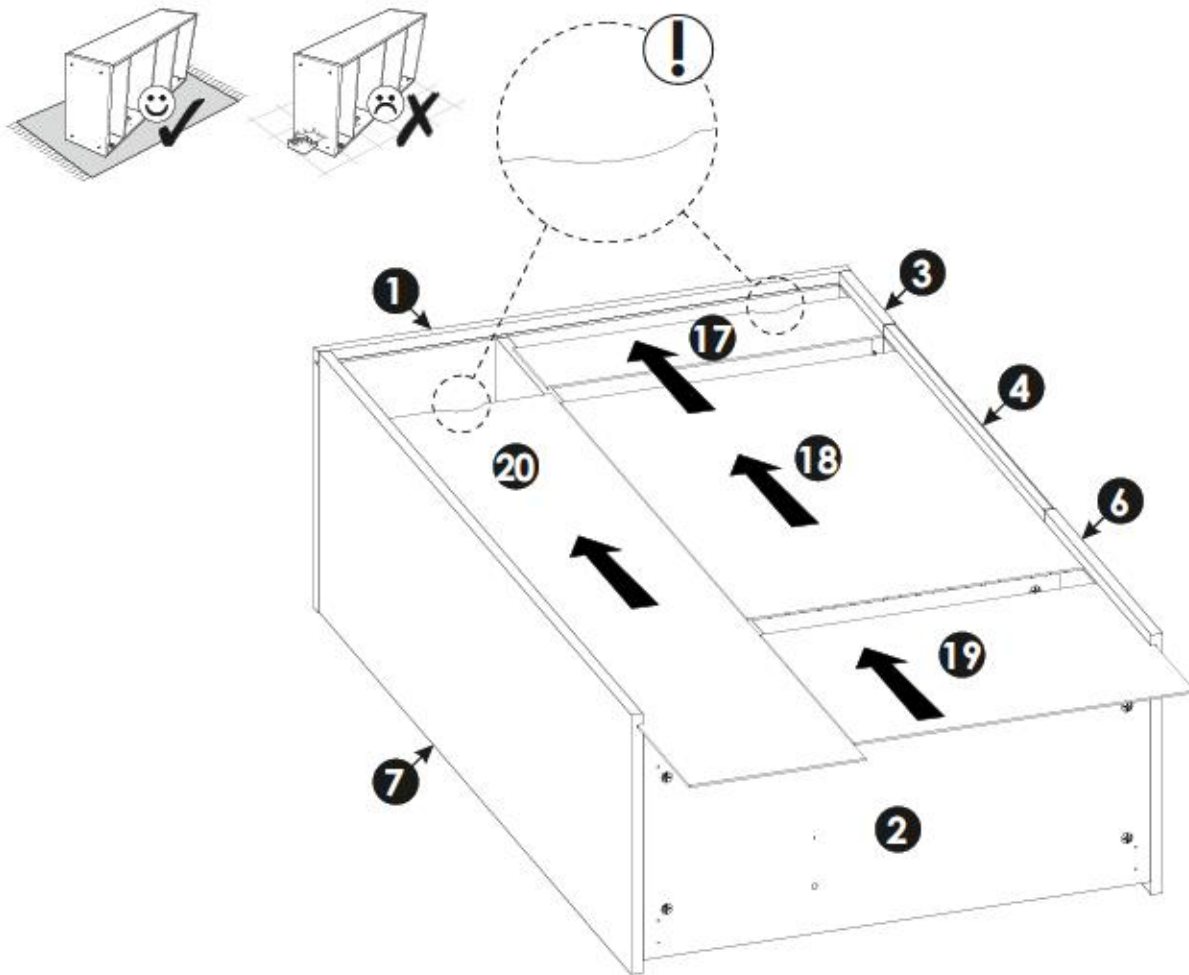

17▶

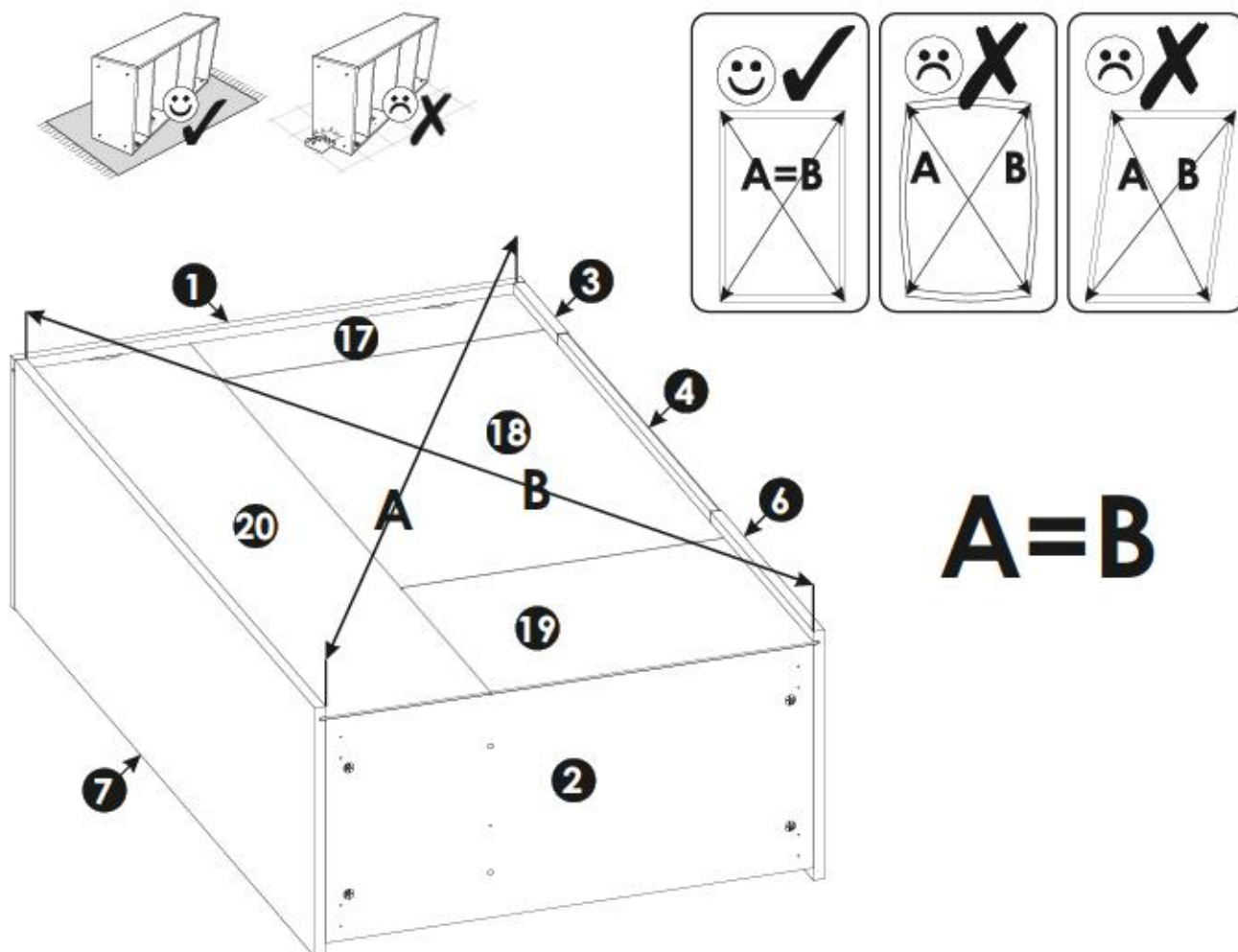

18 ▶

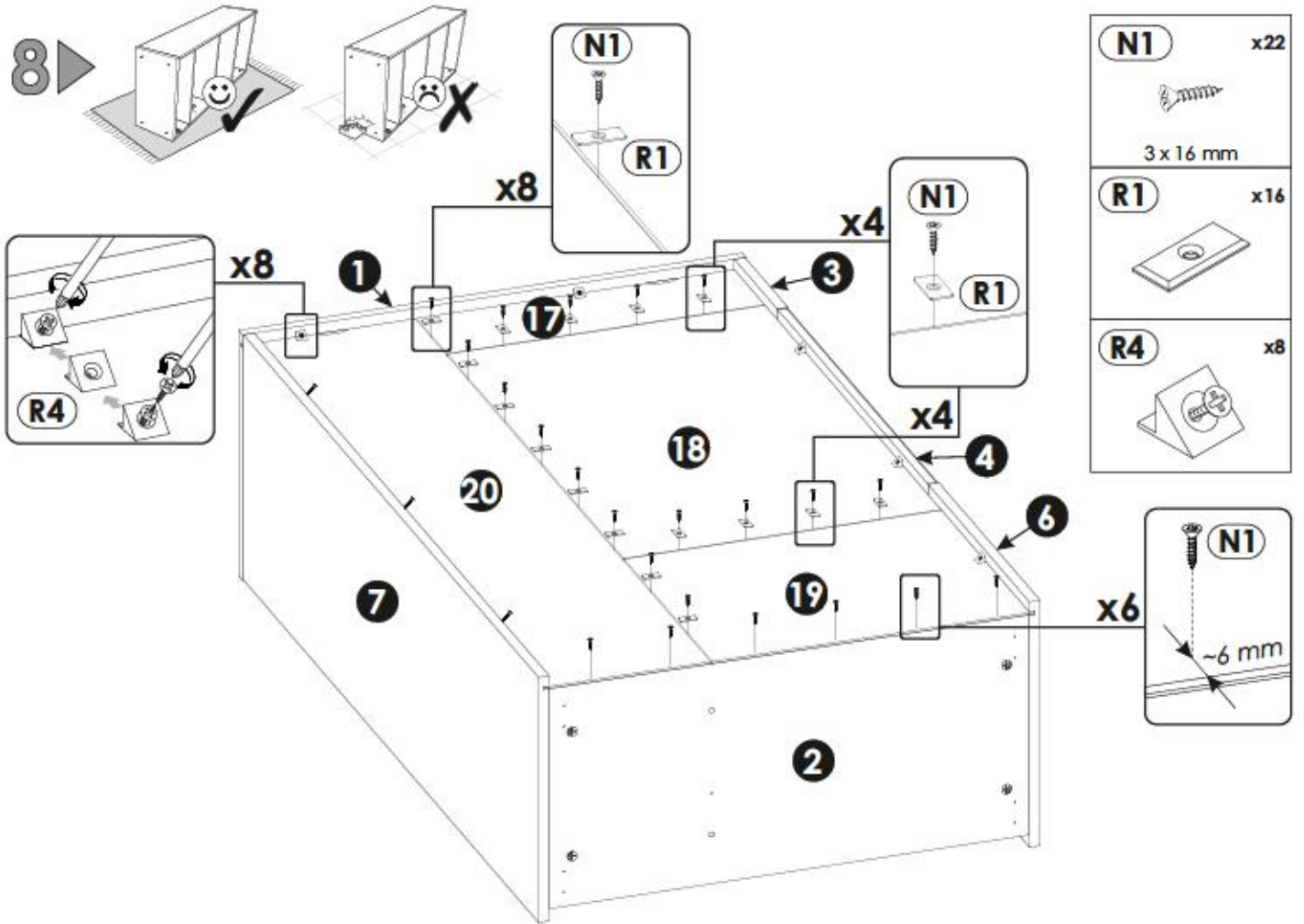
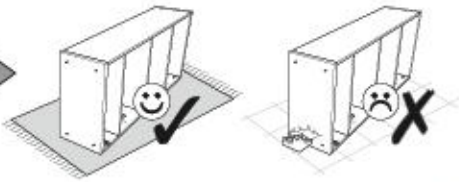

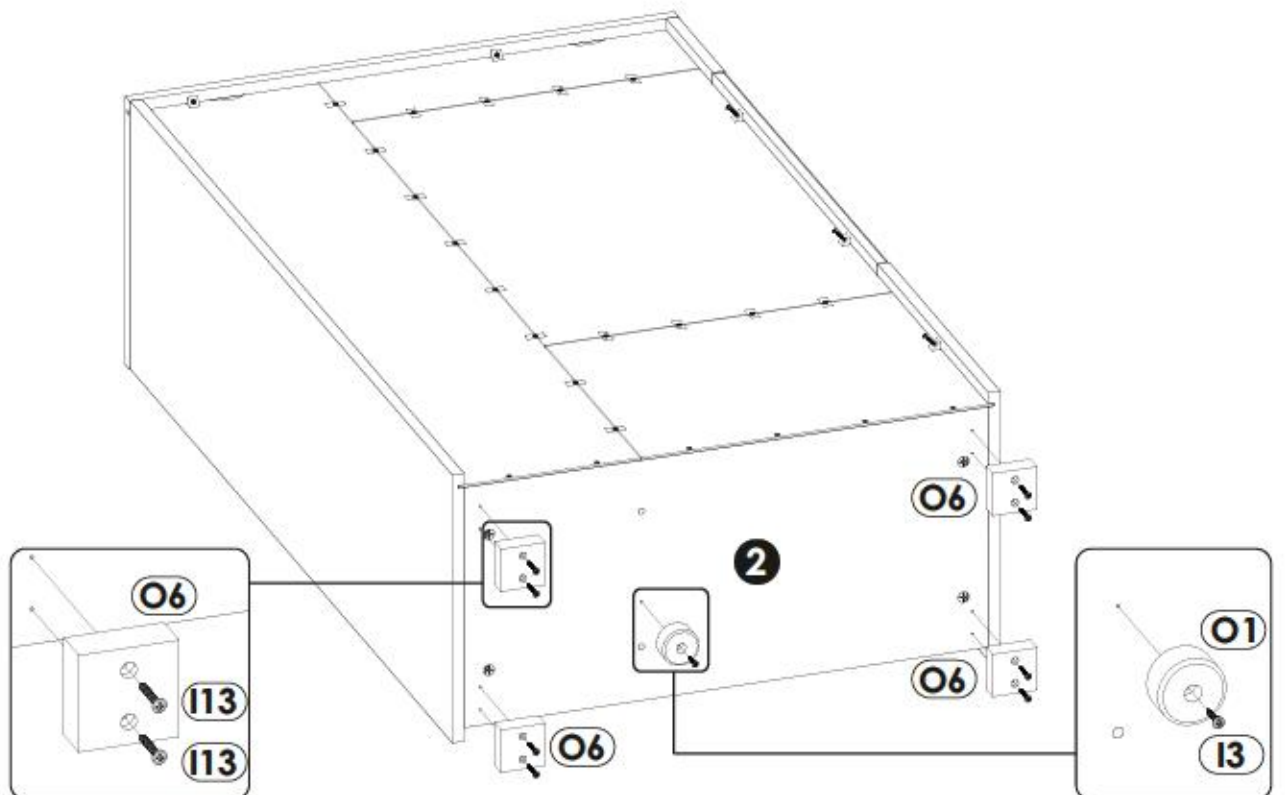
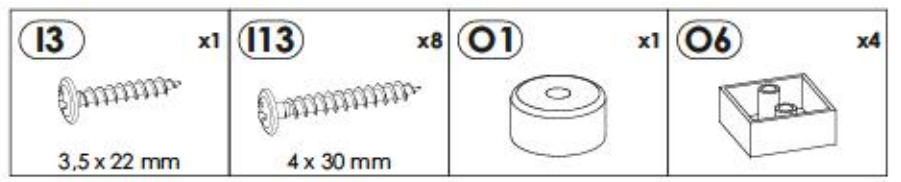
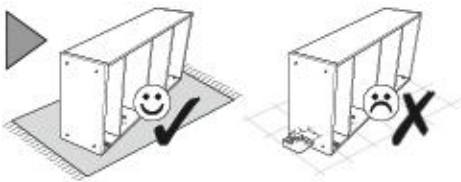

19 ▶

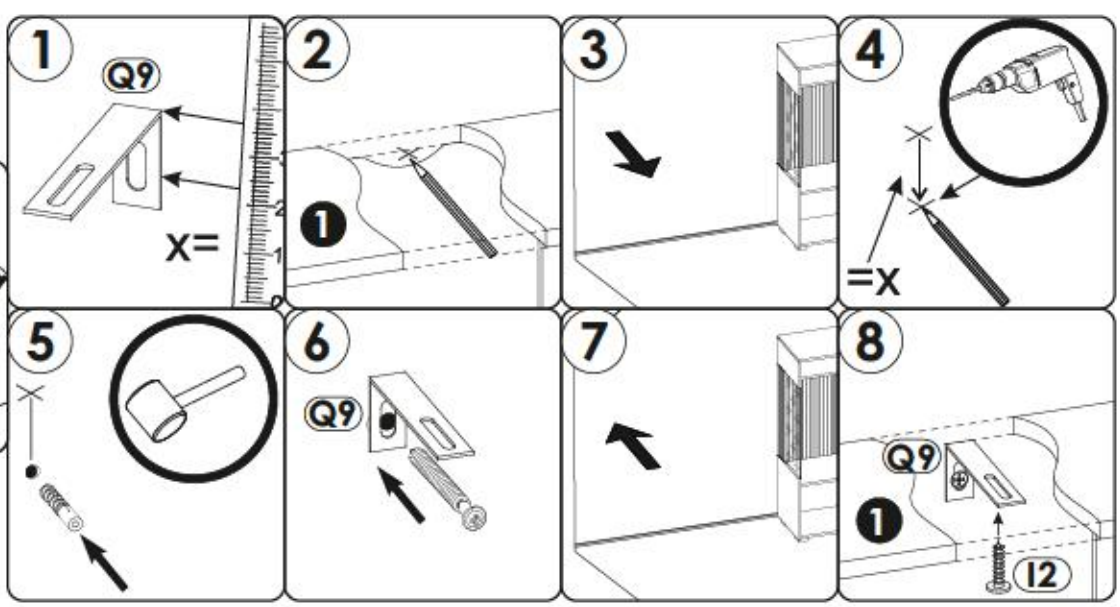
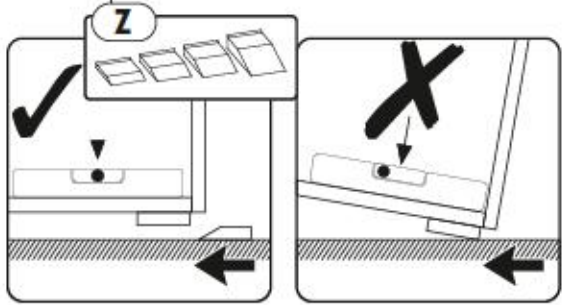
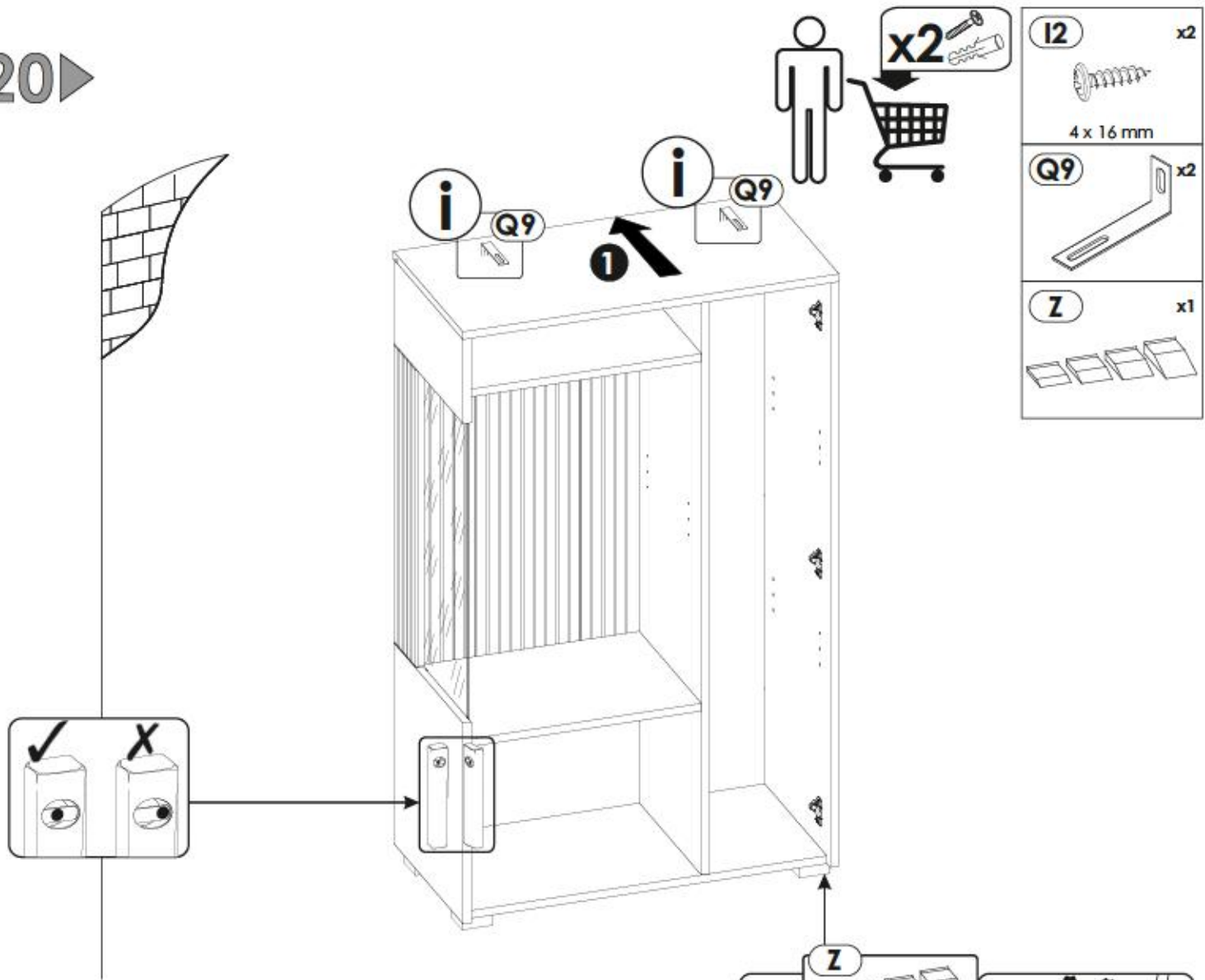

20 ▶



21▶

C2	x3	D2	x8	D5	x3
					
5 x 13 mm					

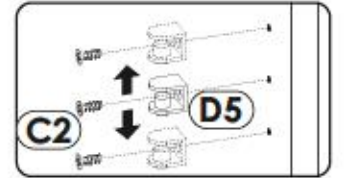
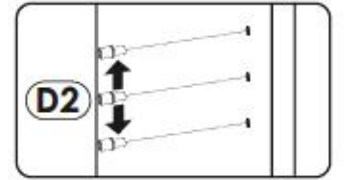
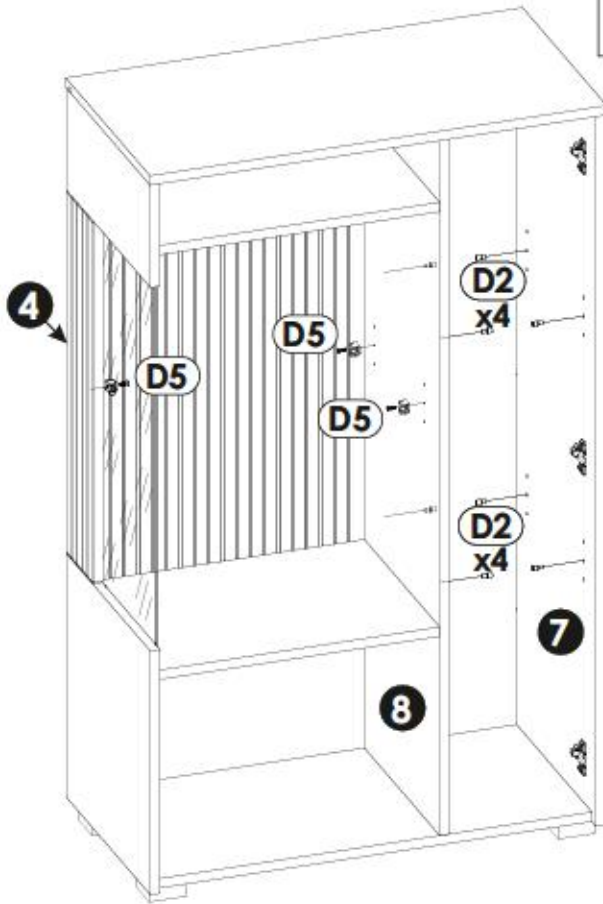

22▶

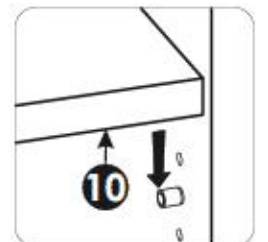
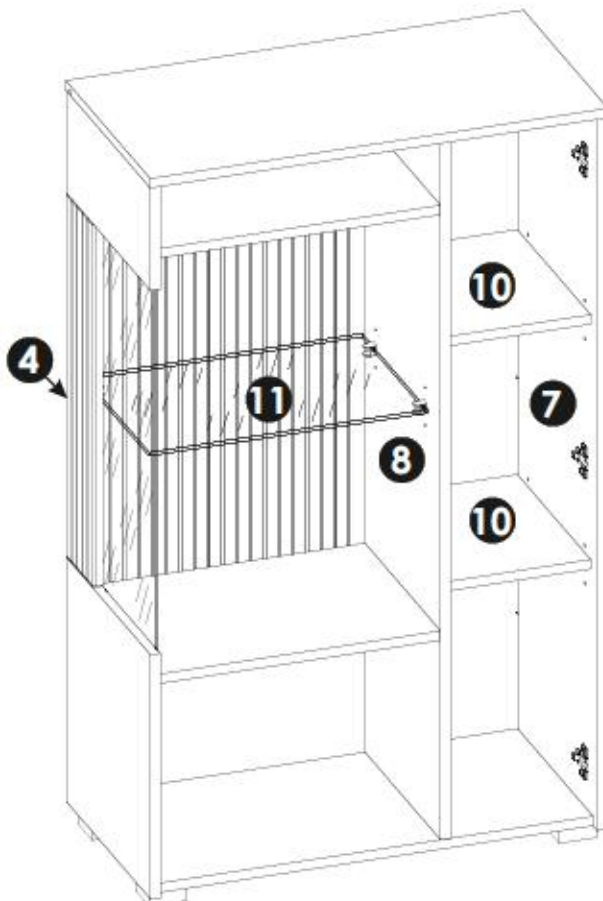

23▶

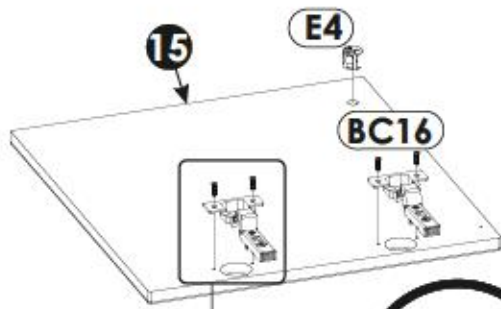

- C2** x4
5 x 13 mm
- BC16** x2
- E4** x1
12 x 10 mm

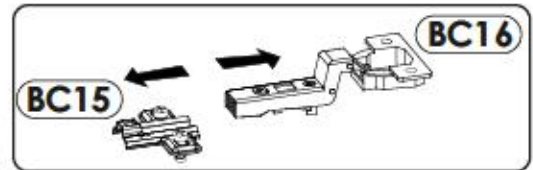
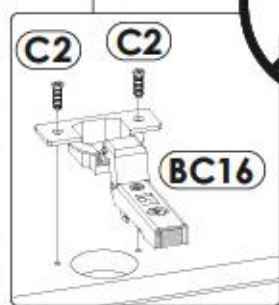
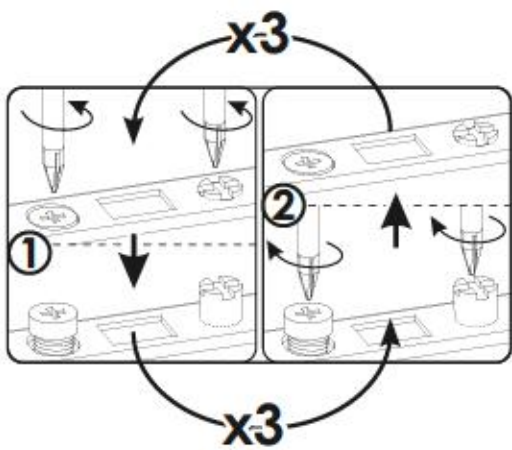

24▶



- E4** x2
12 x 10 mm

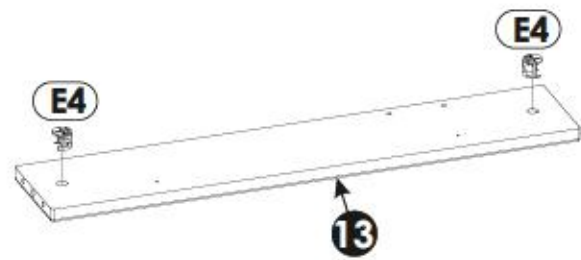

25 ▶

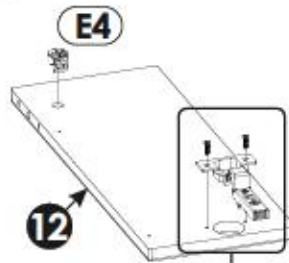

BC16	x1
C2	x2
5 x 13 mm	
E4	x1
12 x 10 mm	

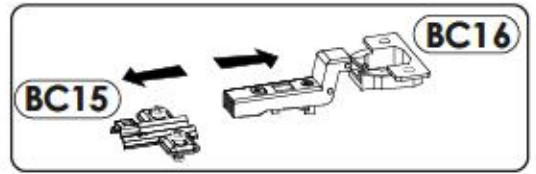
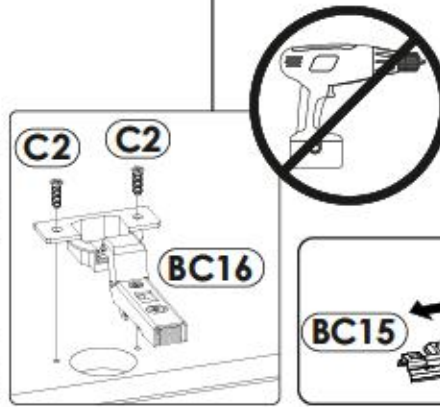
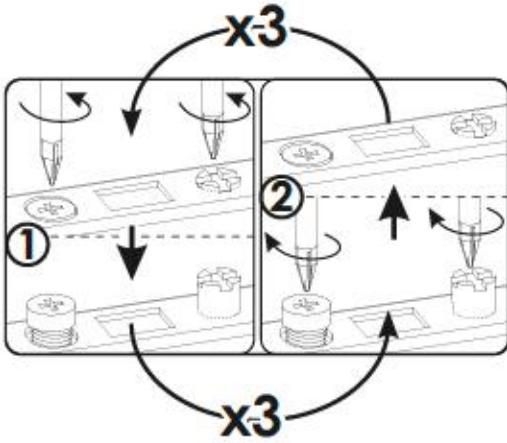

26 ▶

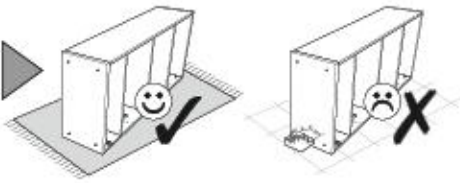

A8	x4	P17	x4	F3	x2
6 x 45 mm		ø20		7 x 64 mm	

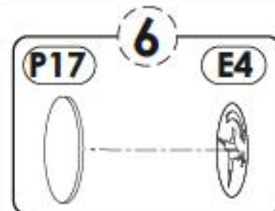
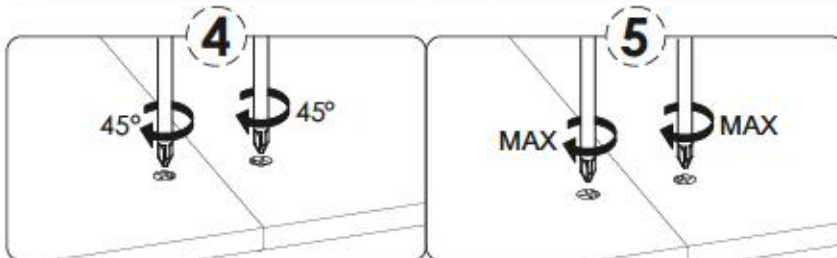
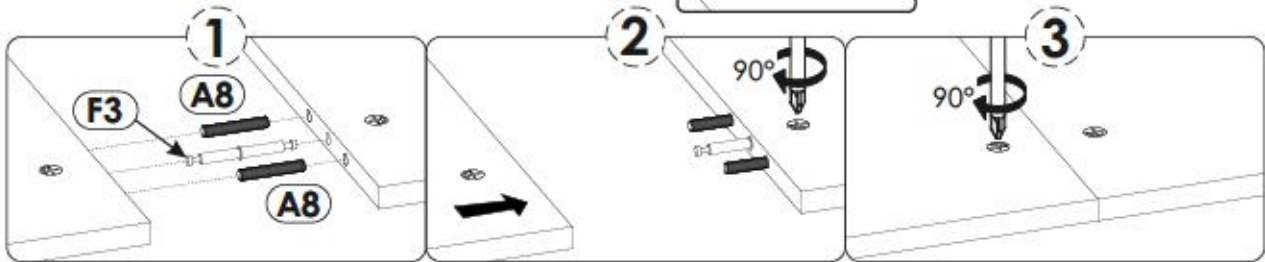
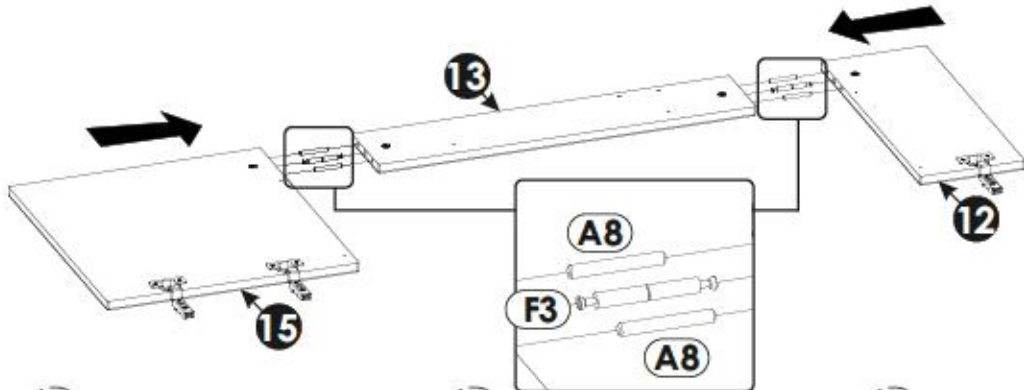

27▶

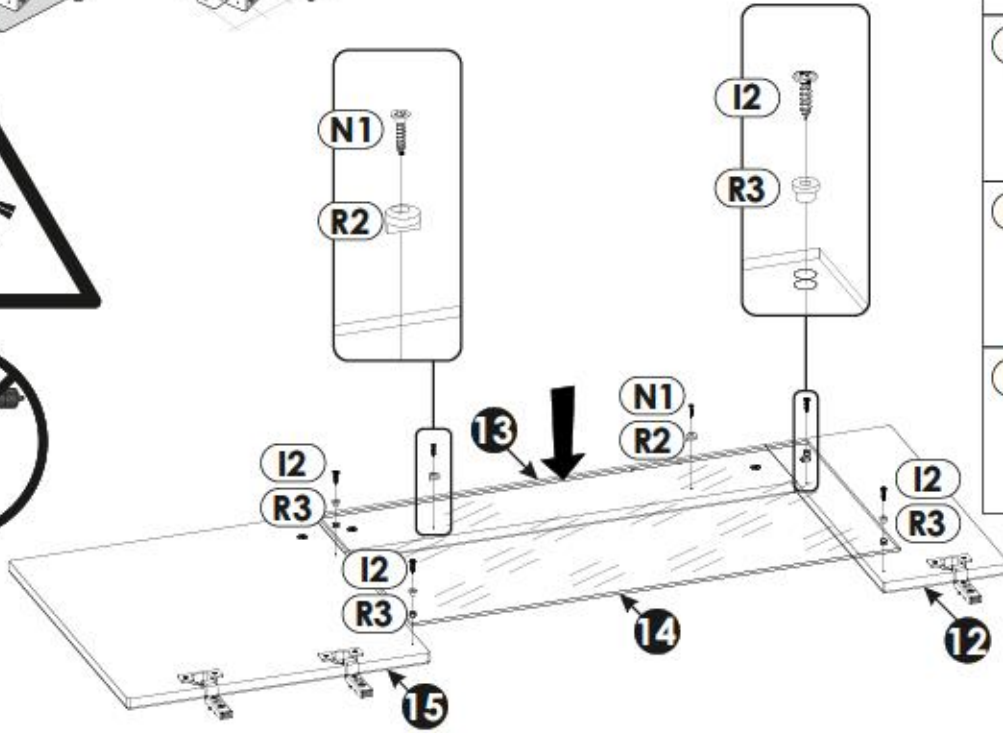
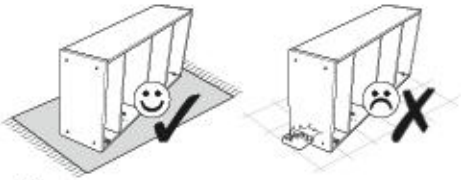

I2	x4
	4 x 16 mm
N1	x2
	3 x 16 mm
R2	x2
R3	x4

28▶

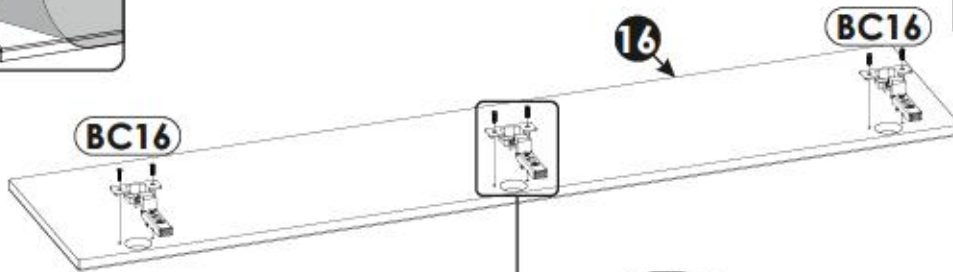

BC16	x3
C2	x6
	5 x 13 mm

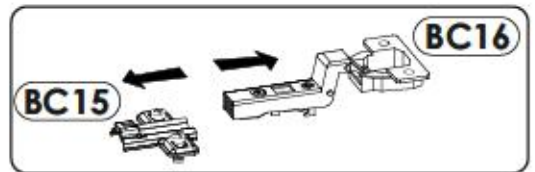
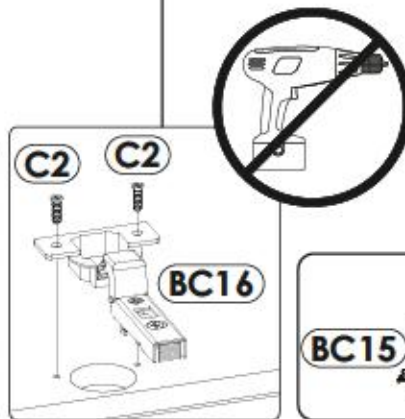
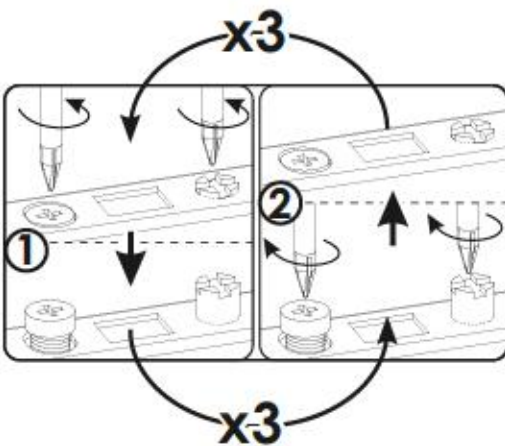

29▶

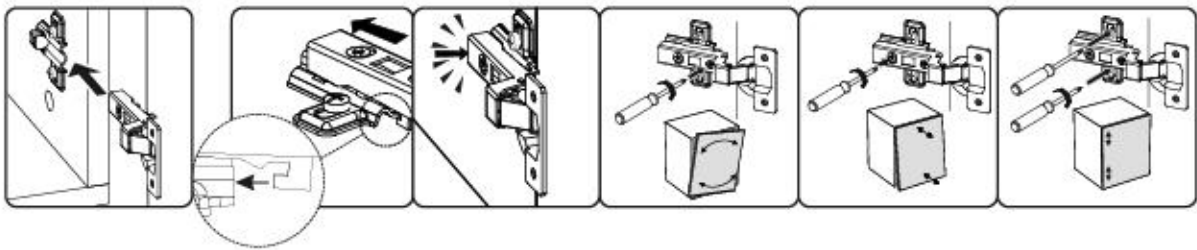
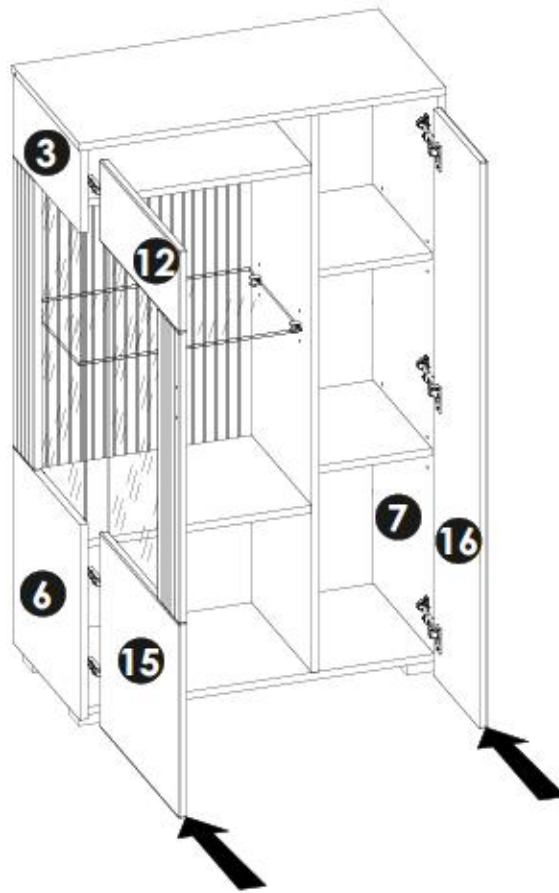

30▶

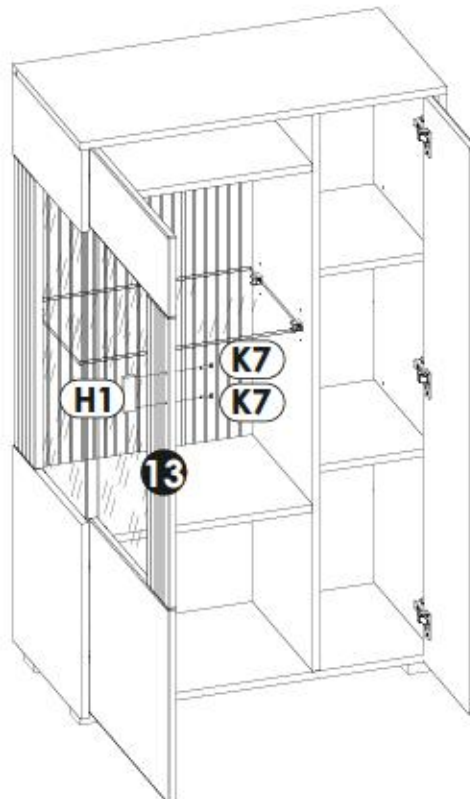

H1	x1
L - 75 mm	
K7	x2
4 x 22 mm	

31 ▶

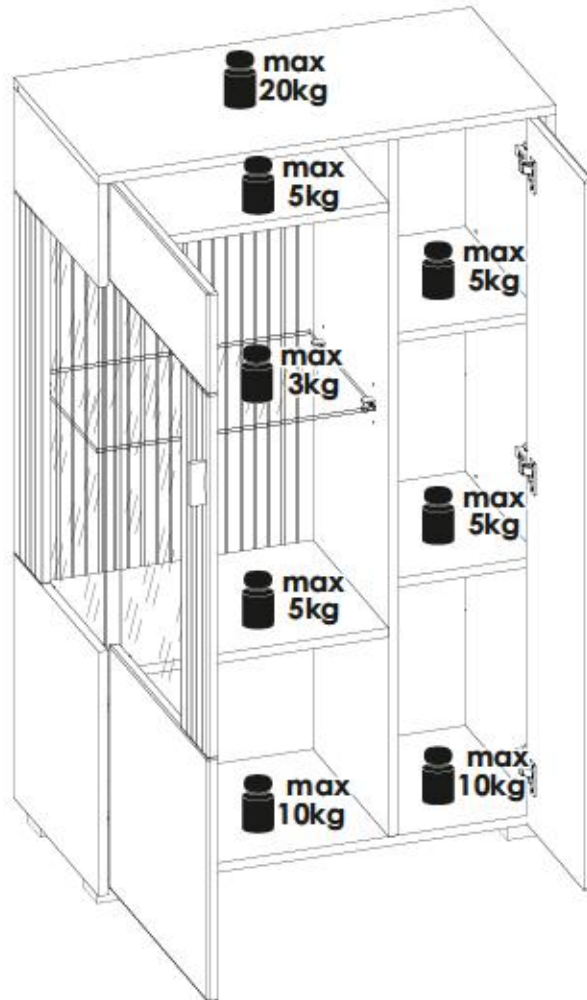

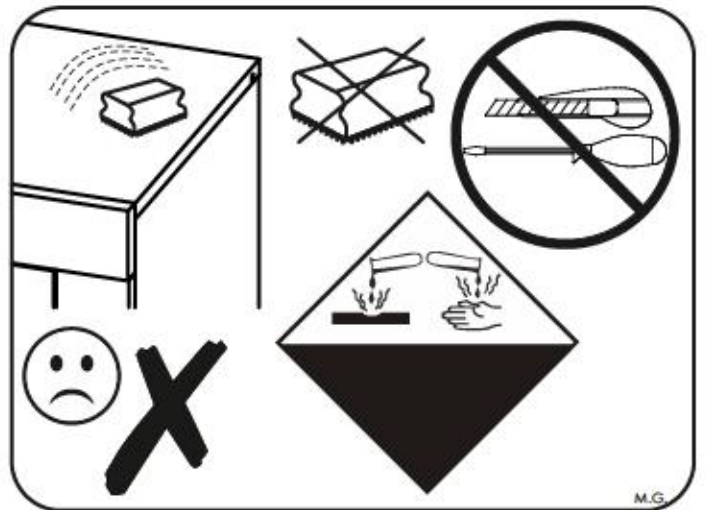
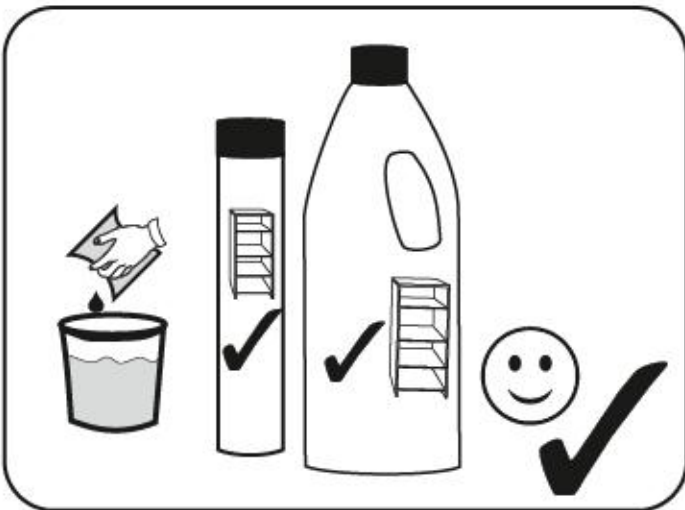
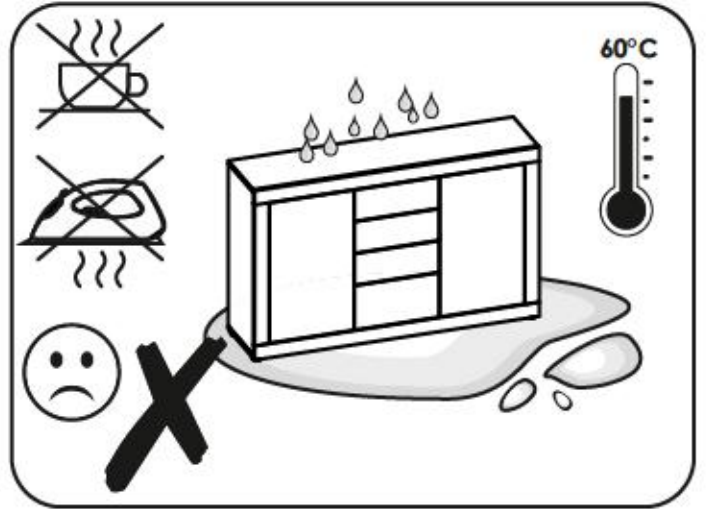
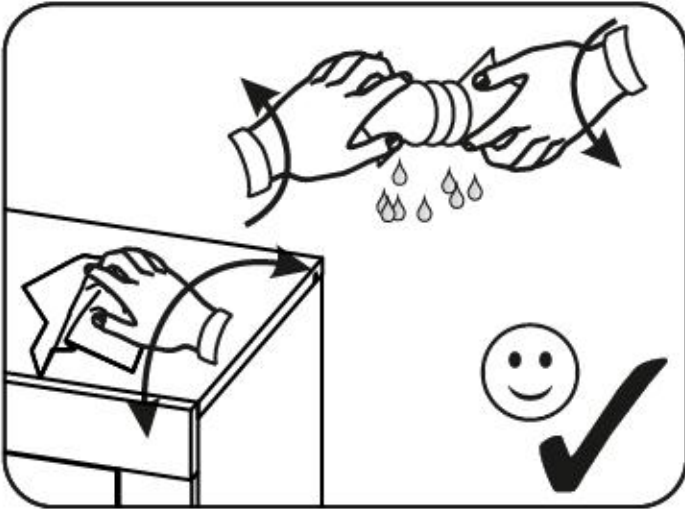
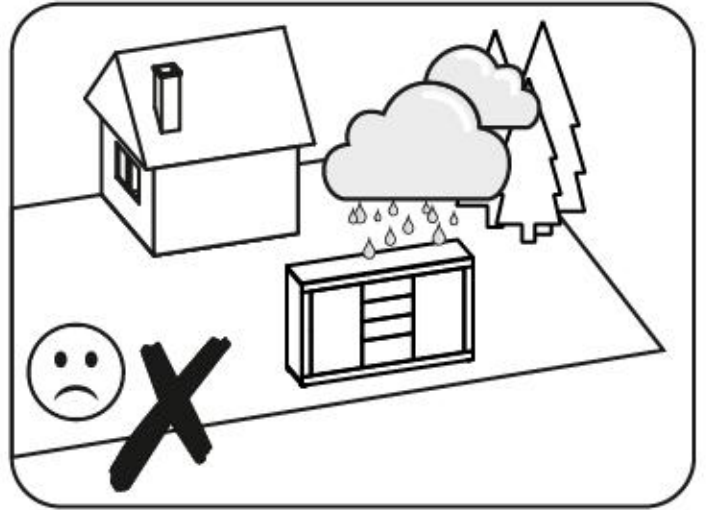
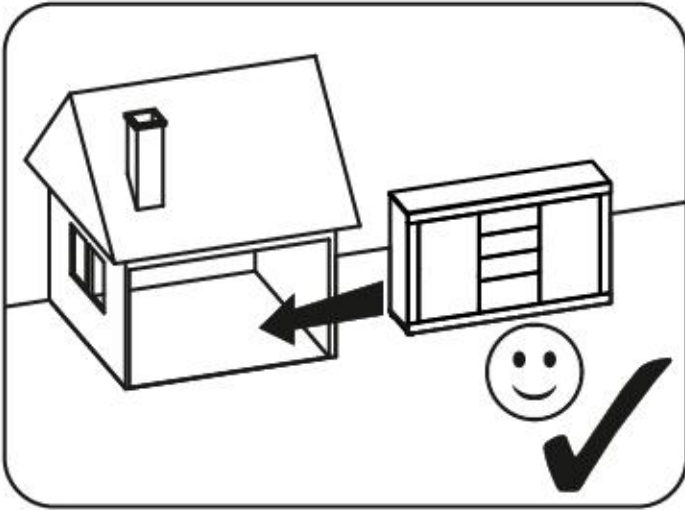

3WSEHU31/3WSYHU31

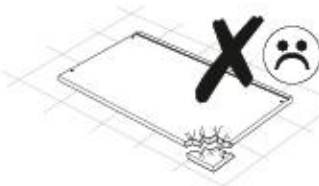
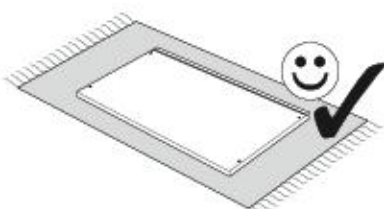
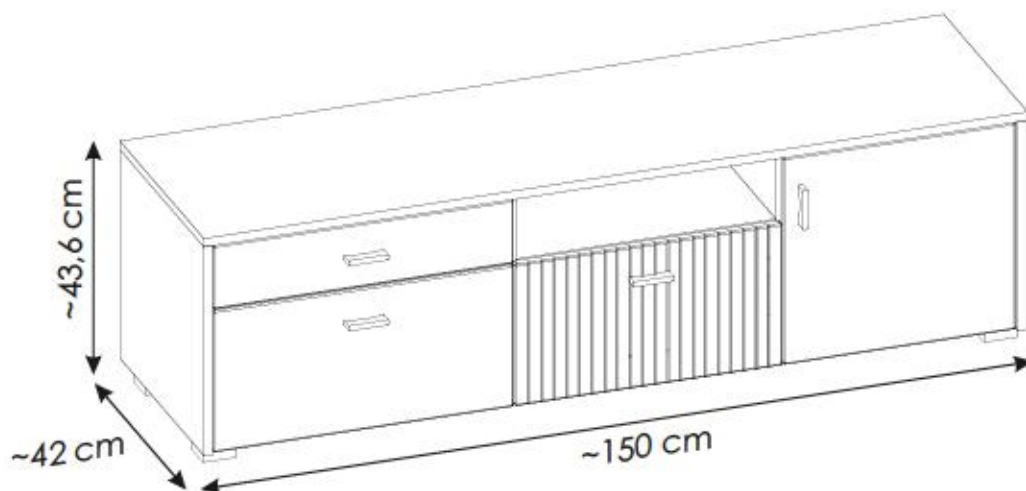

ملاحظة!

يجب تثبيت الأثاث بإحكام إلى الحائط أو الجدار لتجنب خطر إنقلابه. لا تحتوي العلبه على مسامير التثبيت، إذ إنه ينبغي إستعمال المسامير المخصصة لنوعية الحائط أو الجدار. اختر المسامير التي تناسب جدارك.

E.

¡ATENCIÓN! El mueble debe ser fijado permanentemente a la pared para evitar el riesgo relacionado con el vuelco del mueble. En el paquete no hay tornillos de fijación, ya que se debe elegir el tipo de fijación adecuado para el tipo de pared. Elija el apropiado para su tipo de pared.

CN.

注意！本家具需要固定在墙上以免倒塌。箱子里没有安装螺钉。因为安装方式需要根据墙的类型调整。请按照您的墙类型选择合适的安装方式。

SLO.

POZOR! Pohišivo trajno pritrđite na steno, da preprečite tveganje, da se prevrne. V paketu ni pritrđilnih vijakov, saj je treba način pritrđitve ustrezno izbrati glede na vrsto stene. Izberite način, ki je ustrezen za vašo steno.

HU.

FIGYELEM! Rögzítse a bútorokat a falhoz, hogy elkerülje a bútor felborulásának kockázatát. A készletben nem találhatóak rögzítőcsavarok, mivel a rögzítés típusa a fal típusától függ. Válassza ki a fal típusának megfelelő kötőelemeket.

NL.

OPMERKING! De meubelen moeten permanent aan de muur worden bevestigd om te voorkomen dat de meubelen kantelen. Er zitten geen bevestigingsschroeven in het pakket, omdat het type bevestiging moet worden gekozen op basis van het type muur. Kies de juiste voor uw type muur.

EN.

WARNING! To prevent this furniture from tripping over, fix it to the wall permanently. Fixing devices are not included since different wall materials require different types of fixing devices. Please make sure you chose the correct ones for your type of wall.

SK.

POZORI Nábýtok musí byť trvalo pripevnený k stene tak, aby sa zamedzilo riziku prevrátenia. Balík neobsahuje upevňovacie skrutky, pretože typ upevnenia je treba vybrať podľa typu steny. Vyberte typ vhodný pre Vašu stenu.

CZ.

POZORI Nábýtek je nutné pevně připevnit ke zdi, abychom se vyhnuli riziku spojenému s jeho převrnutím. Součástí balení nejsou připevňovací šrouby, protože způsoby připevnění je nutné zvolit podle druhu stěny. Vyberte správný pro Váš typ stěny.

RU.

ПРИМЕЧАНИЕ! Эту мебель необходимо всегда прикреплять к стене, чтобы избежать рисков, связанных с переворотом мебели. В пакете нет крепежных винтов, потому что тип крепления должен быть выбран в соответствии с типом стены. Выберите, пожалуйста, правильные винты к вашей стене.

RO.

ATENȚIE! Mobilă trebuie ancorată permanent în perete pentru a evita riscul de răsturnare a mobilei. În pachet nu sunt incluse șuruburile de fixare, deoarece tipul de ancoraj trebuie ales în funcție de tipul de perete. Alegeți șuruburile potrivite pentru tipul Dvs. de perete.

TR.

DIKKATİ! Devrimle riskini önlemek için mobilya duvara sabitlenmelidir. Sabitleme civataları pakete dahil değildir, çünkü sabitleme tertibatının tipi, duvara tipine uygun olarak seçilmelidir. Onu duvannızın tipine göre seçiniz.

PL.

UWAGA! Mebel należy trwale zamocować do ściany, aby uniknąć ryzyka związanego z przewróceniem się mebla. W paczce nie ma śrub mocujących, ponieważ rodzaj mocowania należy odpowiednio dobrać do rodzaju ściany. Dobierz właściwe do Twojego rodzaju ściany.

D.

ACHTUNG! Um alle mit dem Umkippen des Möbels verbundenen Risiken auszuschließen, muss das Möbel fest an der Wand verankert werden. Beschläge für die Wandbefestigung sind nicht beige packt, da diese von der jeweiligen Wandbeschaffenheit abhängig sind. Bitte solche Befestigungsschläge wählen, die für die heimischen Wände geeignet sind.

FR.

ATTENTION! Ce meuble doit être fixé en permanence au mur pour éviter les risques de chute. Les vis de fixation ne sont pas livrées car le type de fixation doit être choisi en fonction du type de mur. Sélectionnez les fixations adaptées au mur.

I.

ATTENZIONE! Il mobile deve essere permanentemente fissato alla parete per evitare i rischi derivanti da un ribaltamento del mobile. La confezione non include le viti di fissaggio, in quanto il tipo di fissaggio deve essere scelto in base al tipo di parete. Utilizzare viti appropriate in base al materiale della parete.

HR.

NAPOMENA! Namještaj mora biti trajno pričvršćen za zid, kako bi se izbjegao rizik od njegovog prevrtanja. U paketu nema vijaka za pričvršćivanje, jer se vrsta montaže mora prilagoditi vrsti zida. Odaberite pravu vrstu prema Vašoj vrsti zida.

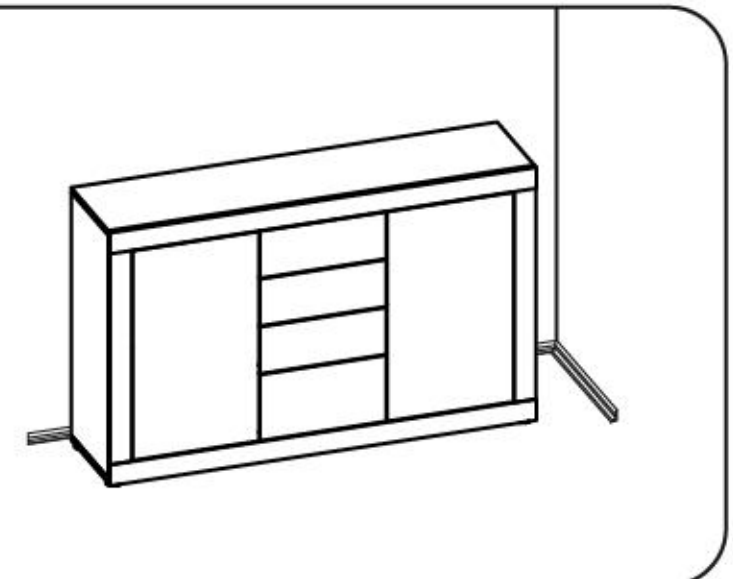
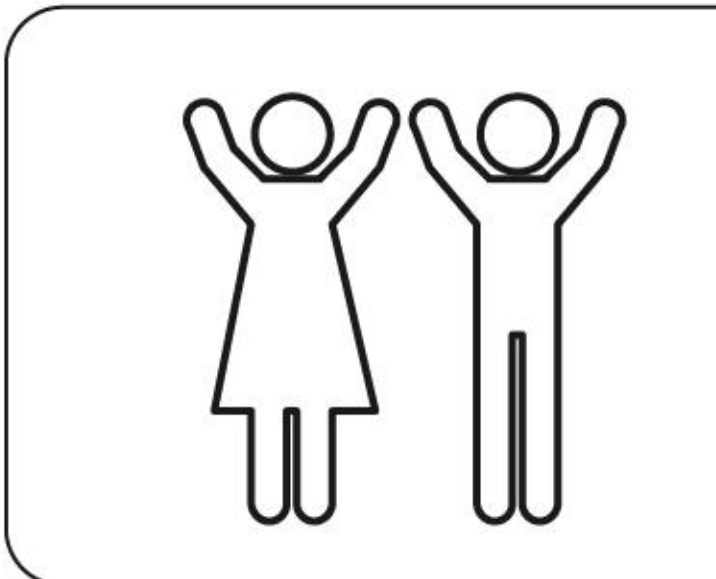
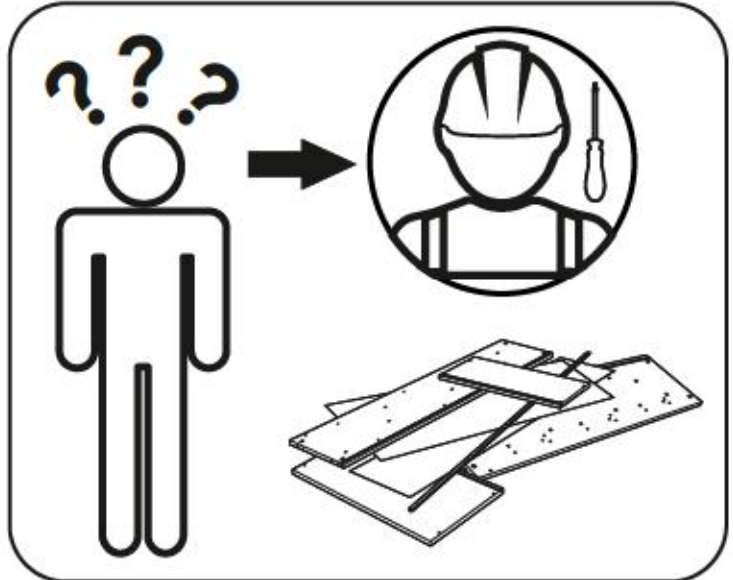
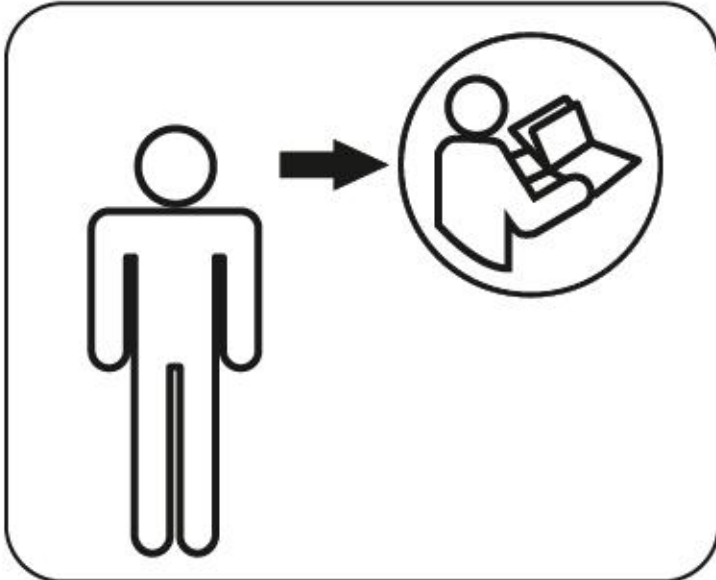
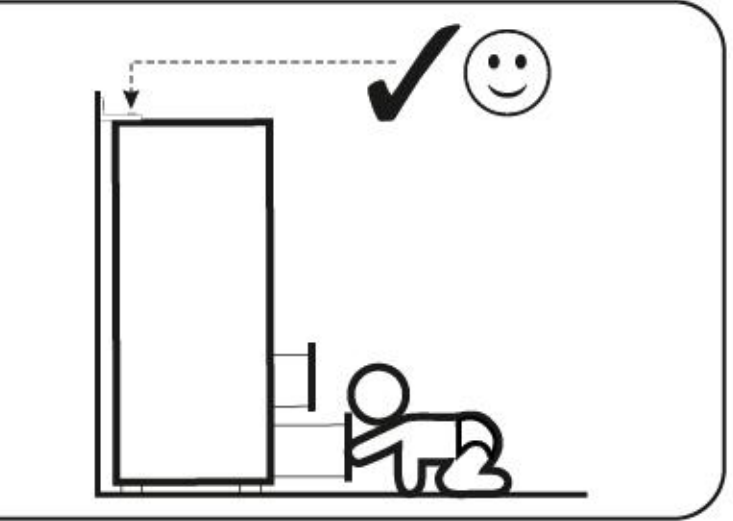
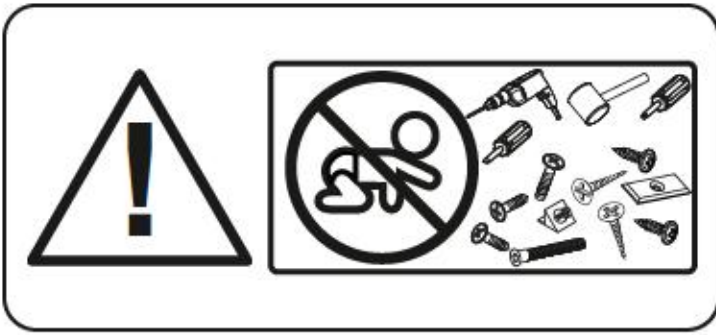



version A

Bx

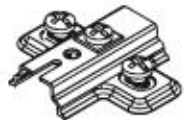

Bx



Bx + Bx

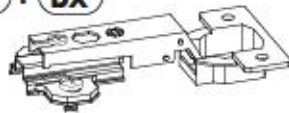

Bx

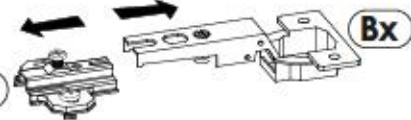

Bx

BCxx

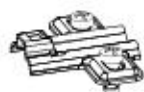

BCxx

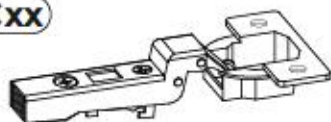

BCxx + BCxx



BCxx

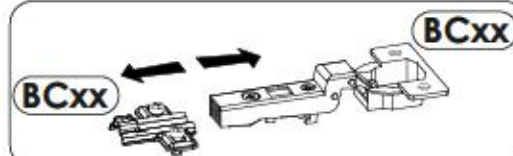

BCxx

BCxx



BCxx



BCxx + BCxx



BCxx

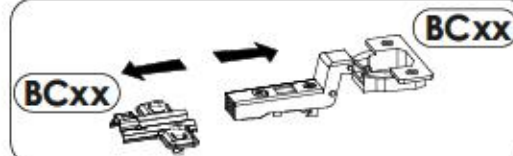

BCxx

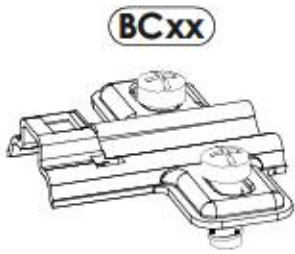

OK

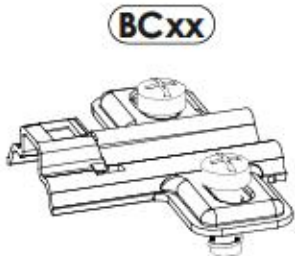
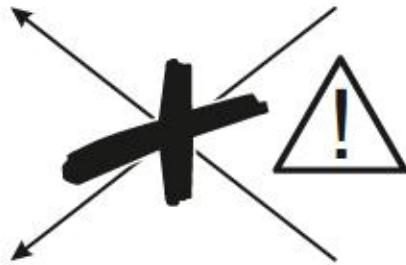
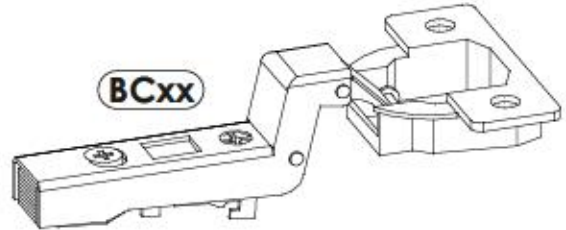

OK

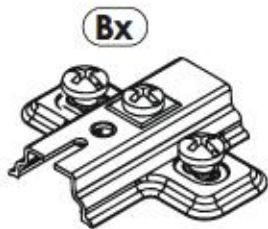
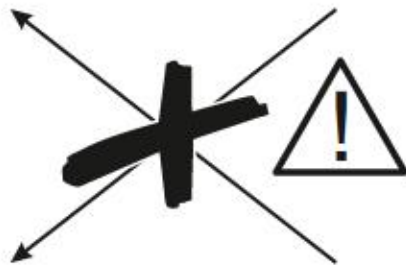
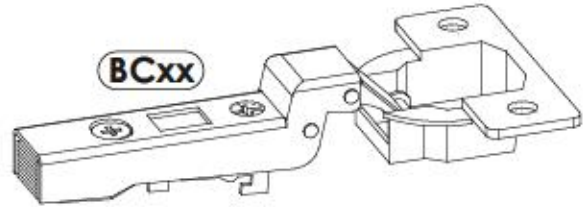



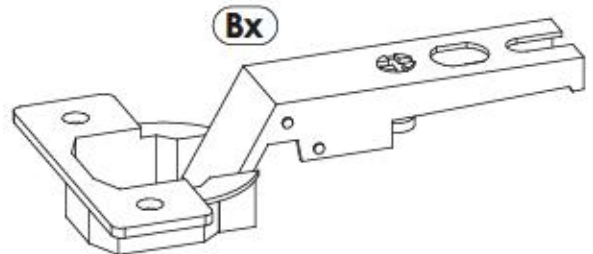



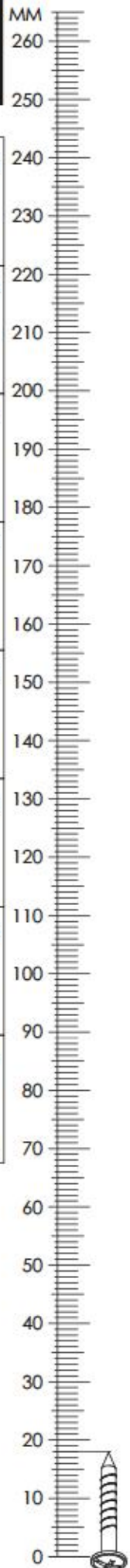









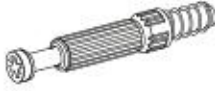

OK

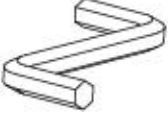

3WSEHU31/3WSYHU31

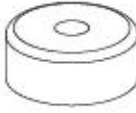
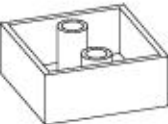
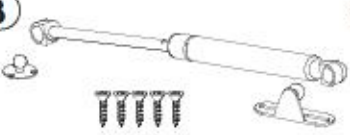
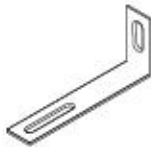

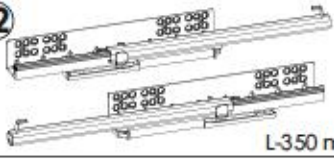
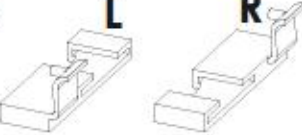
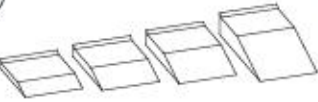
A1 8 x 35 mm x24 	B0 + B1 x2 	BC13 + BC14 x2 
BC15 + BC16 x2 	C2 5 x 13 mm x16 	D2 x2 
E0 Ø16 x10 	E1 15 x 12 mm x18 	F1 6 x 34 mm x18 
G1 7 x 50 mm x6 	H1 L - 75 mm x4 	I2 4 x 16 mm x2 
I3 3.5 x 22 mm x2 	I13 4 x 30 mm x8 	K7 4 x 22 mm x8 
M x1 	N1 3 x 16 mm x20 	O1 x2 
O6 x4 	PB x1 	Q9 x2 
R1 x4 	R4 x6 	T12 x1 L-350 mm 
TZ L R x1 	Z x1 	

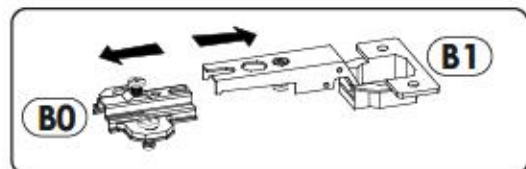
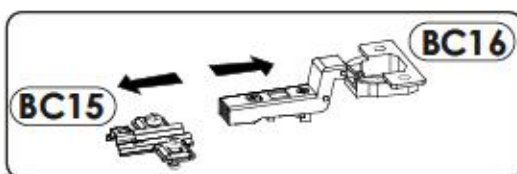
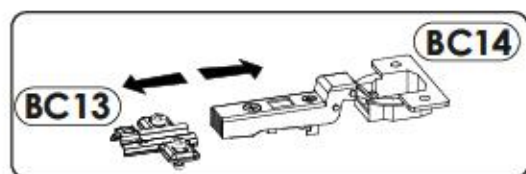

3WSEHU31 / 3WSYHU31

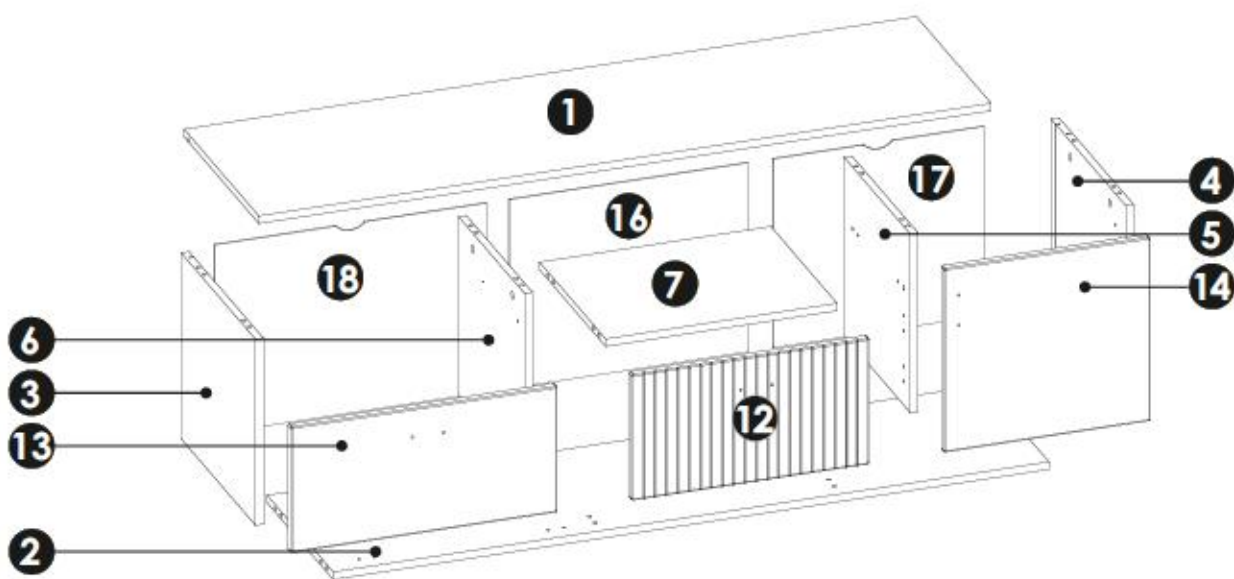
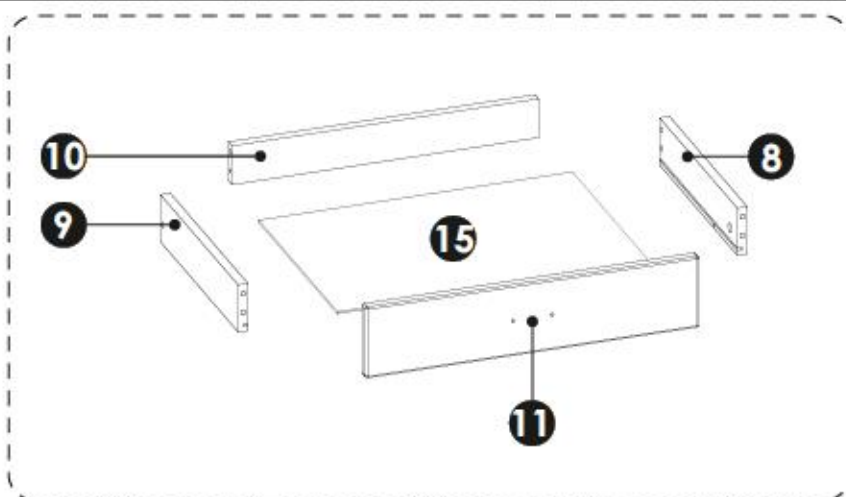

1	1500	420	16	x1	1/1
2	1466	372	16	x1	1/1
3	395	419	16	x1	1/1
4	395	419	16	x1	1/1
5	379	372	16	x1	1/1
6	379	372	16	x1	1/1
7	474	372	16	x1	1/1
8	350	80	16	x1	1/1
9	350	80	16	x1	1/1

10	502	66	16	x1	1/1
11	546	120	16	x1	1/1
12	267	486	16	x1	1/1
13	546	267	16	x1	1/1
14	422	390	16	x1	1/1
15	514	355	3	x1	1/1
16	401	488	3	x1	1/1
17	401	432	3	x1	1/1
18	401	556	3	x1	1/1

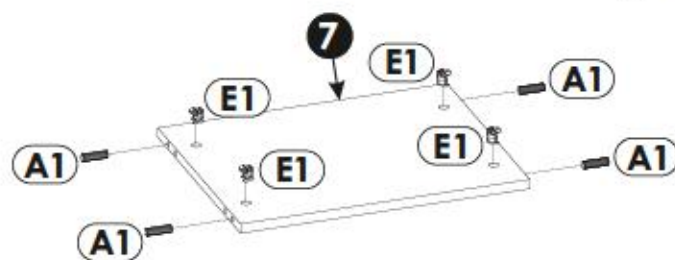
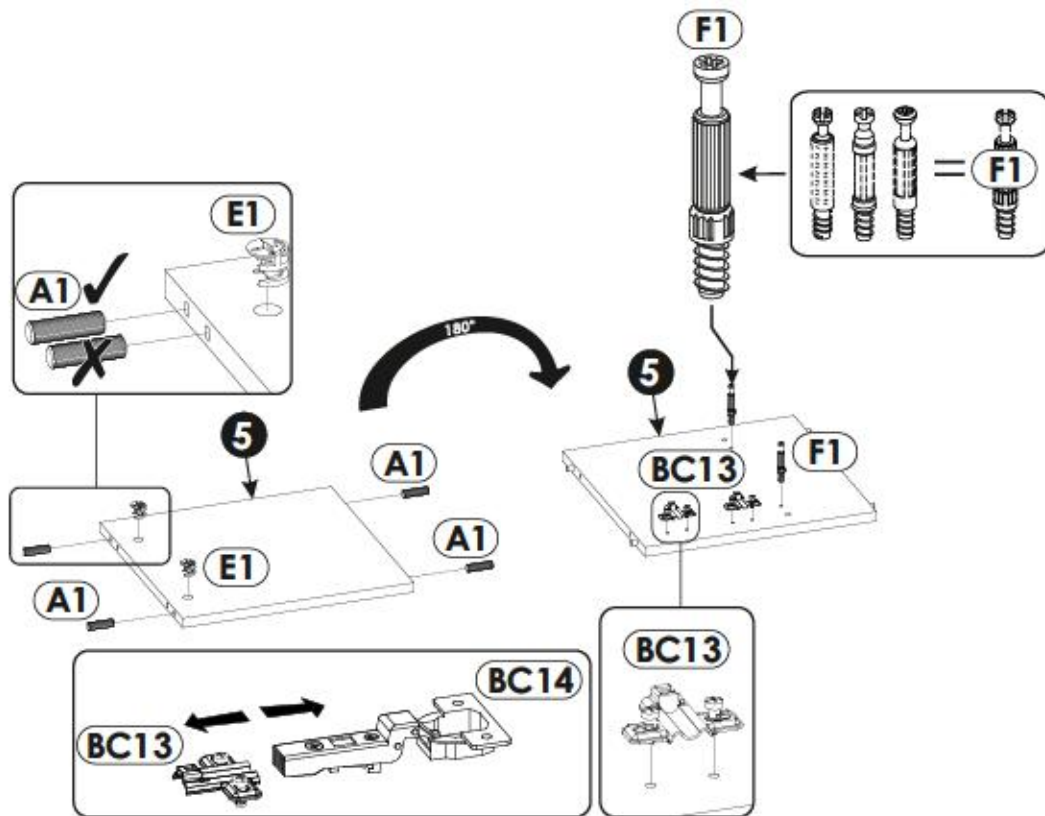
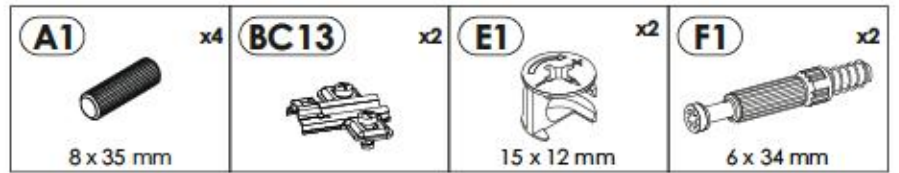
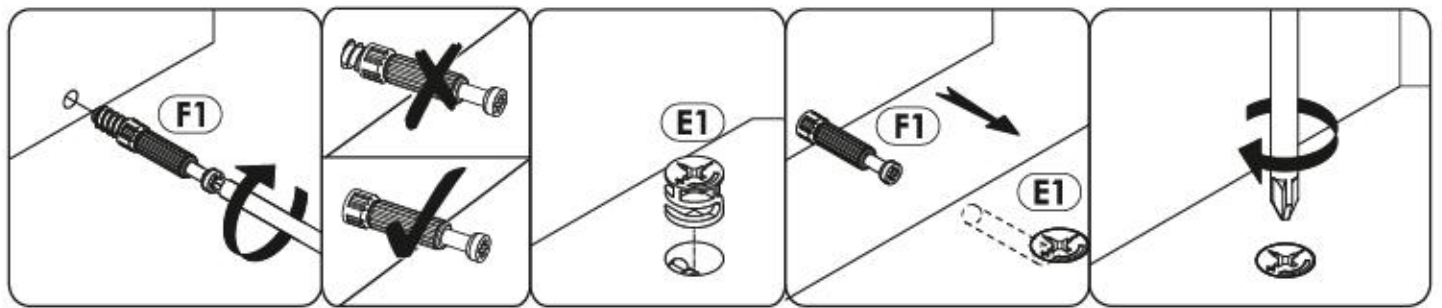

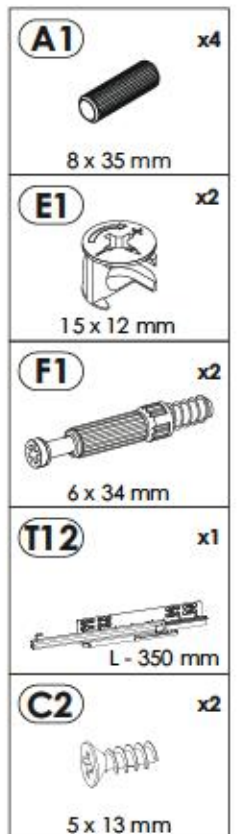
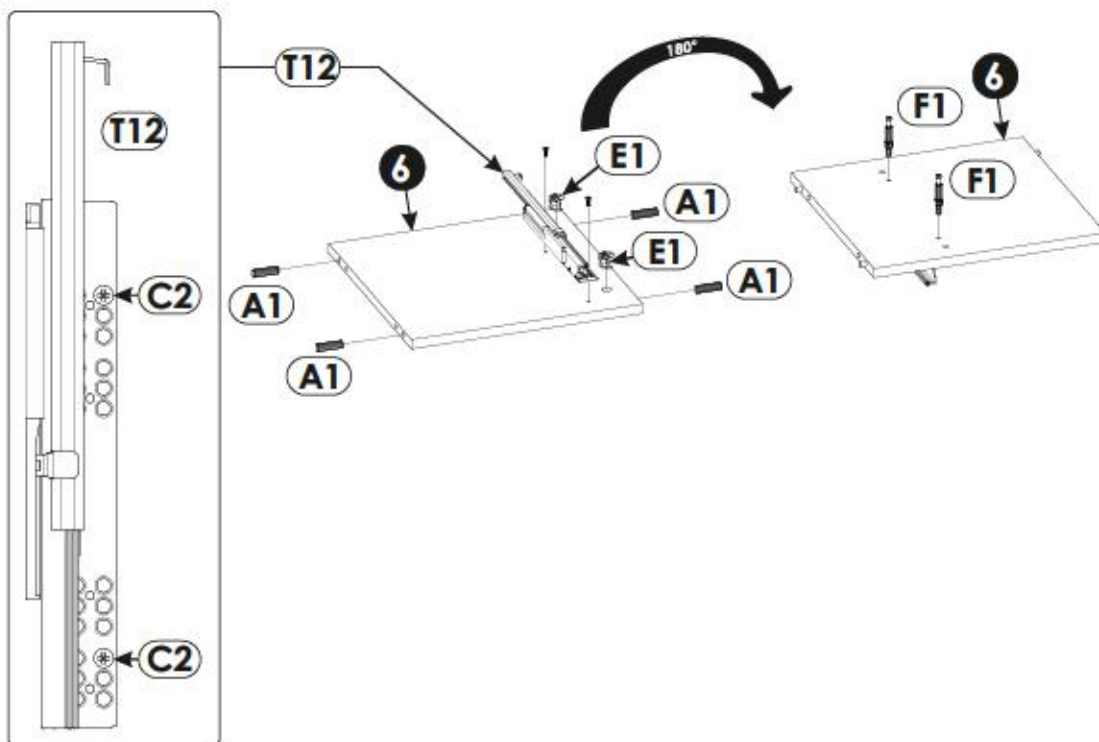
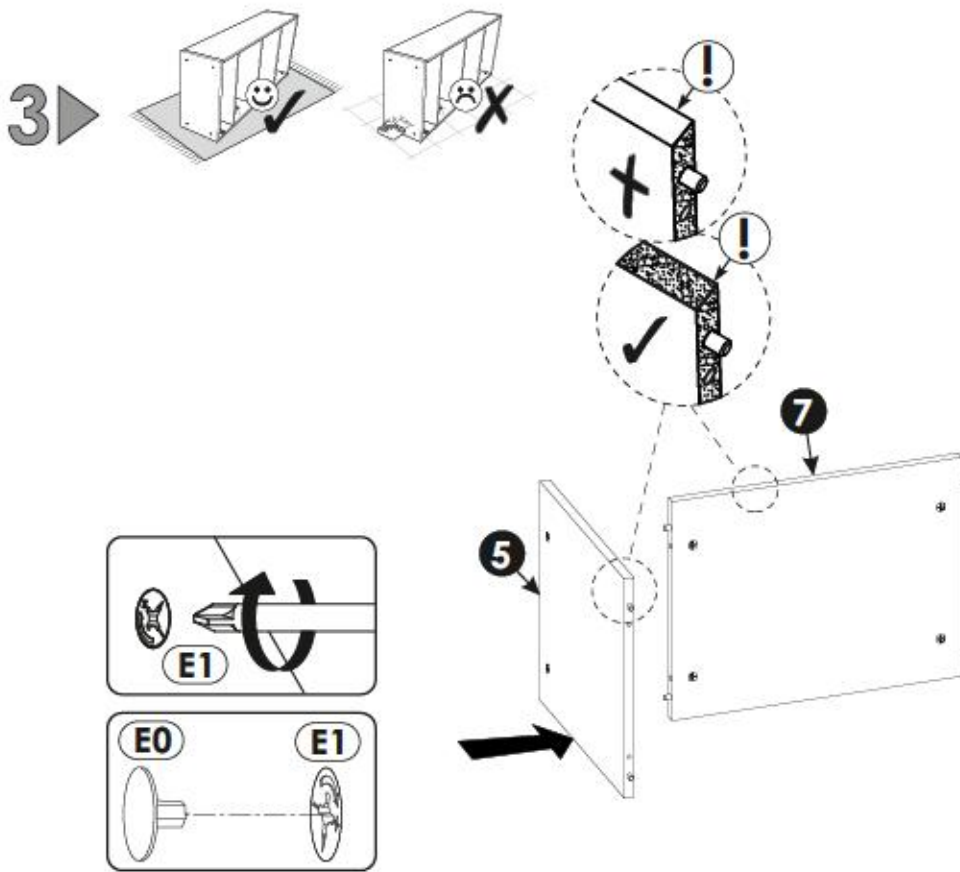

5 ▶

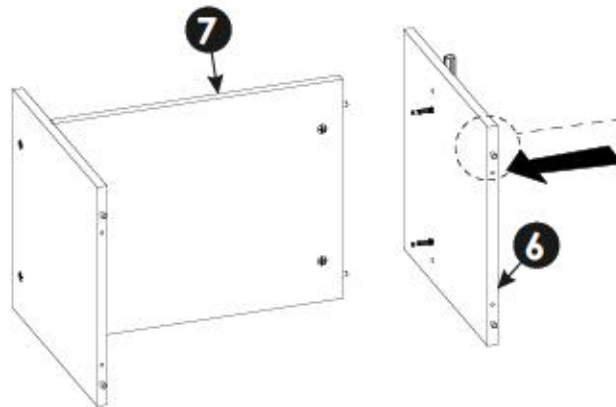
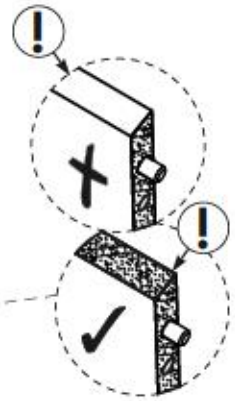
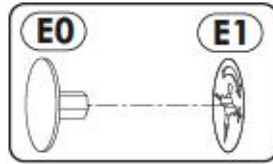
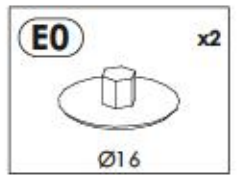
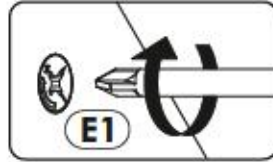
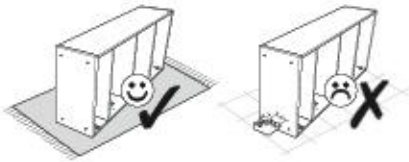

6 ▶

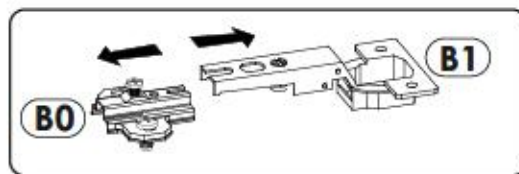
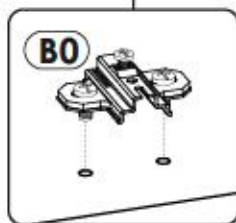
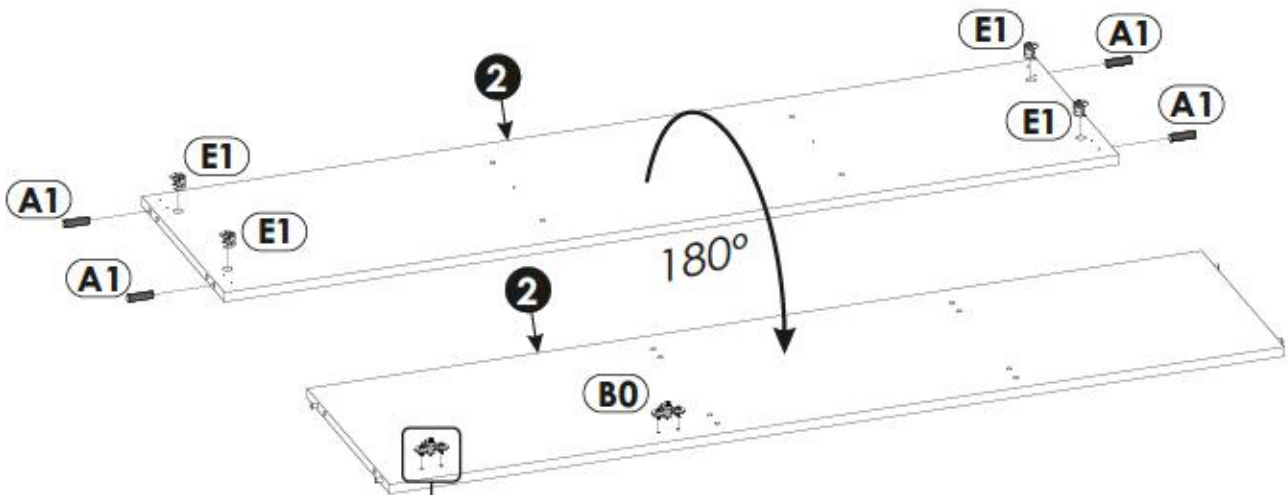
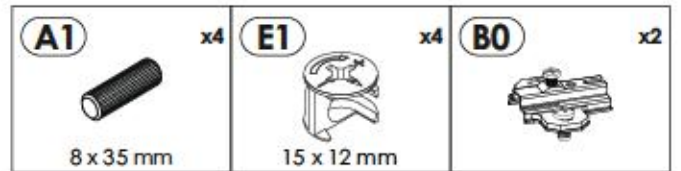

7 ▶

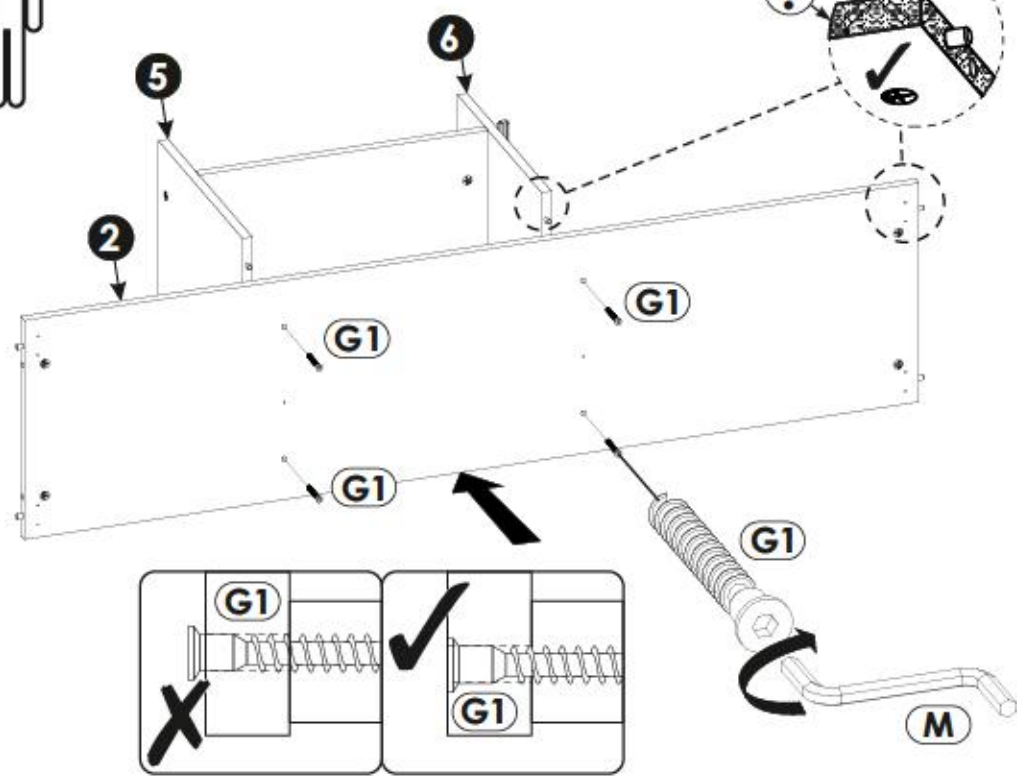
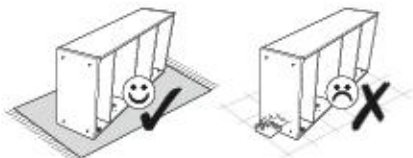

G1 x4
7 x 50 mm

8 ▶

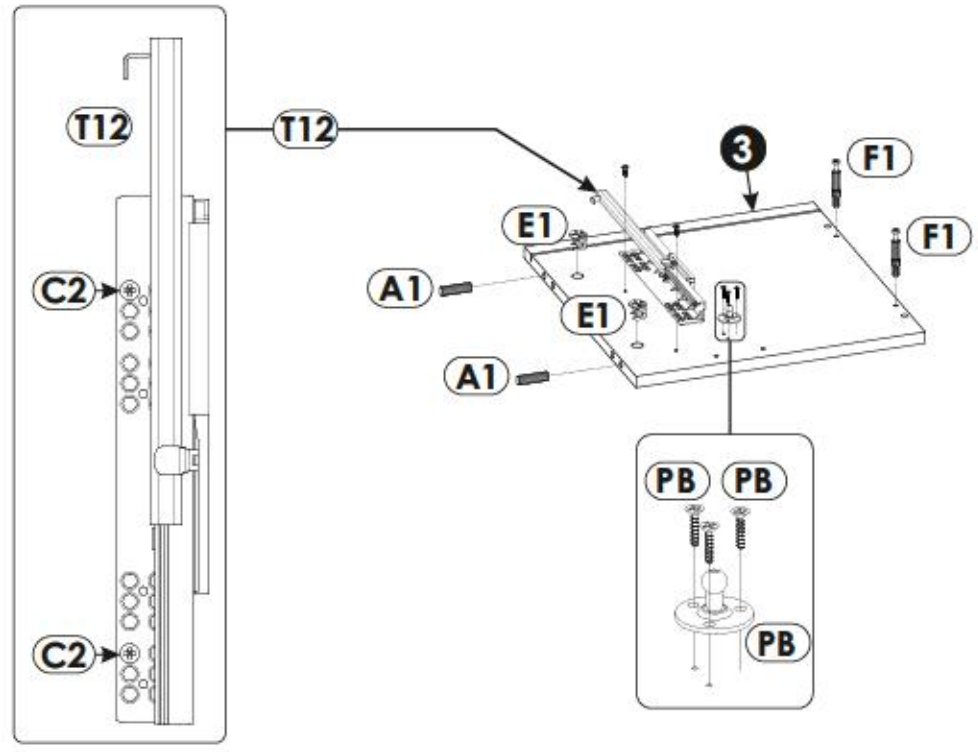

A1 x2
8 x 35 mm

E1 x2
15 x 12 mm





F1 x2
6 x 34 mm

T12 x1
L - 350 mm

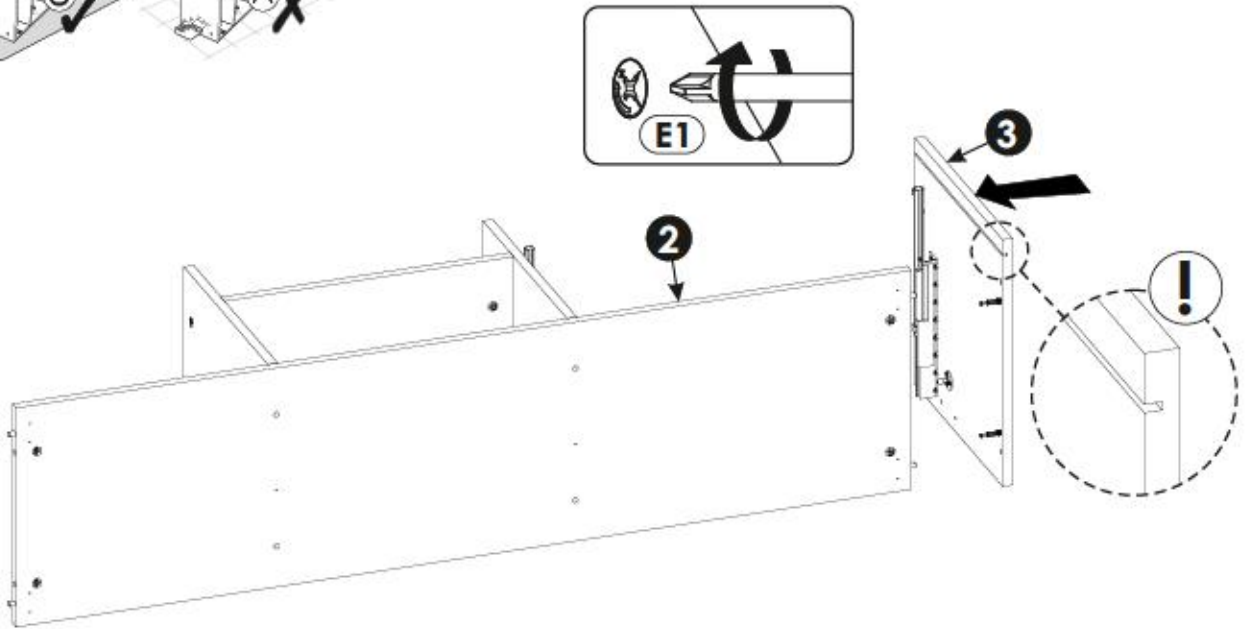
C2 x2
5 x 13 mm

PB x1



A1	x2	E1	x2	F1	x2	BC15	x2
							
8 x 35 mm		15 x 12 mm		6 x 34 mm			

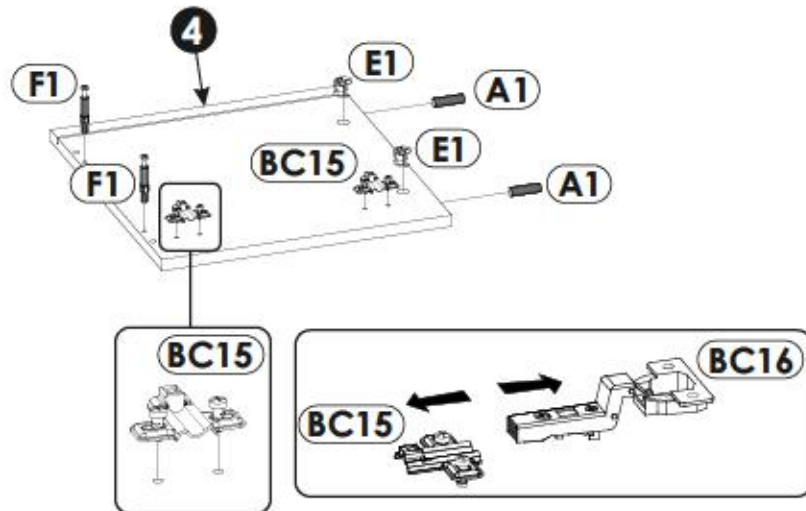

11▶

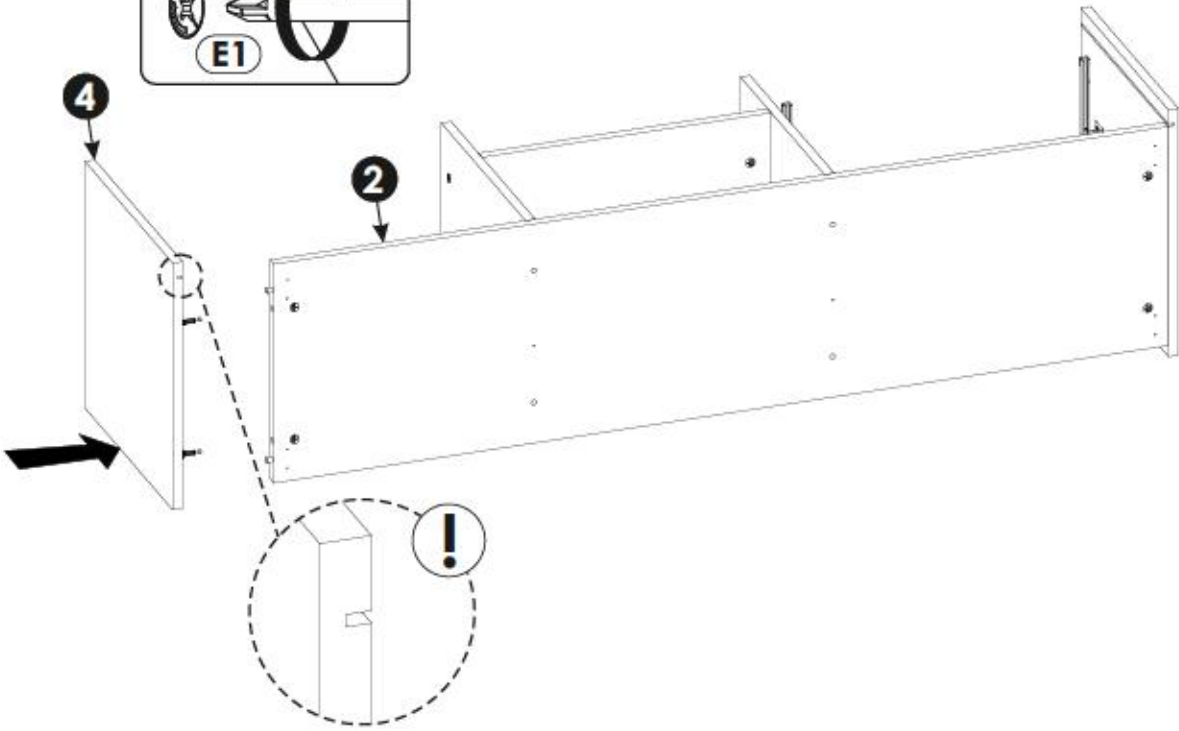
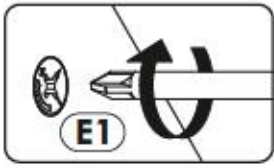
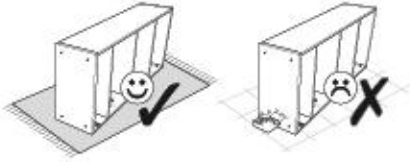

12▶

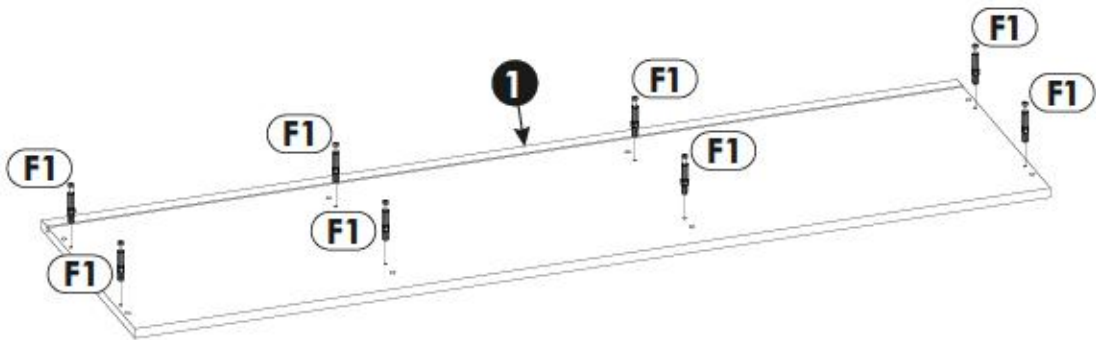
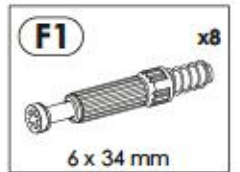

13▶

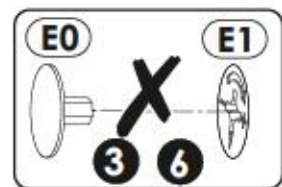
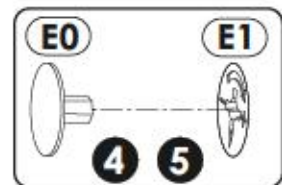
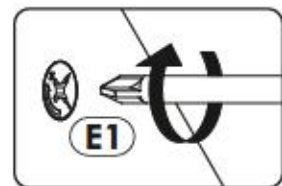
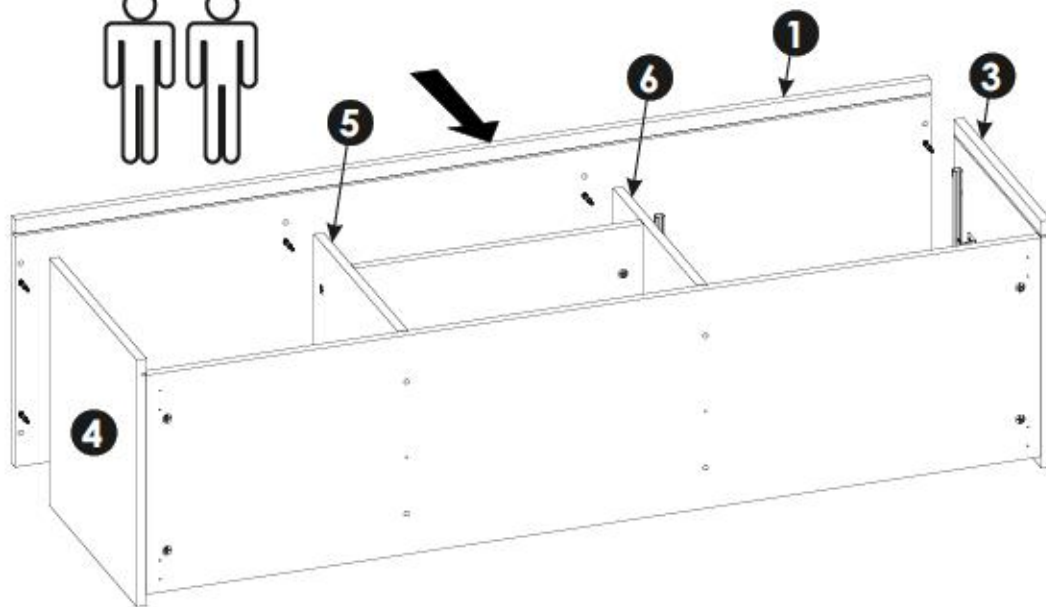
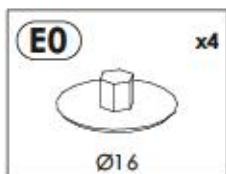
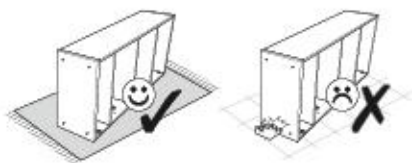

14▶

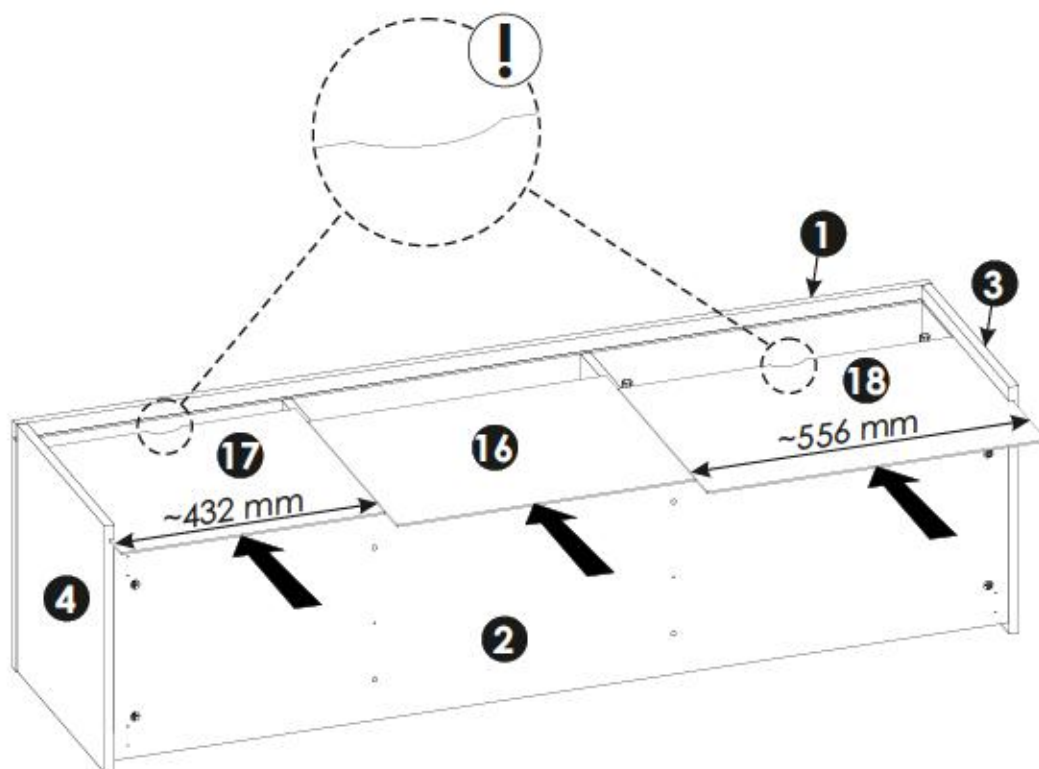
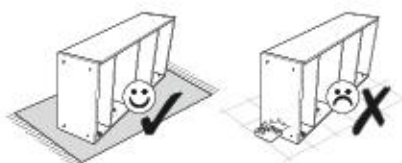

15 ▶

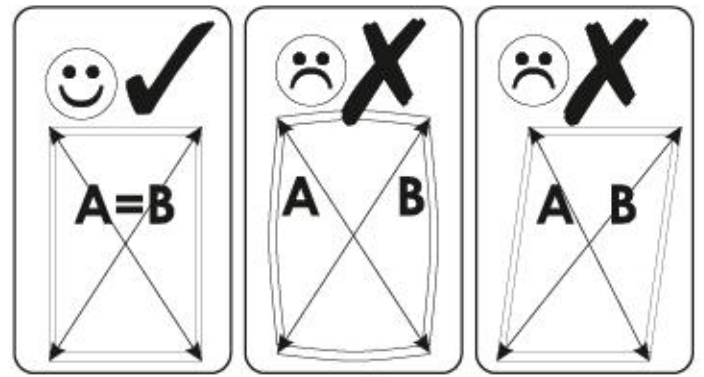
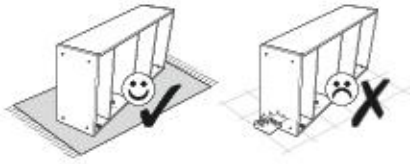

A=B

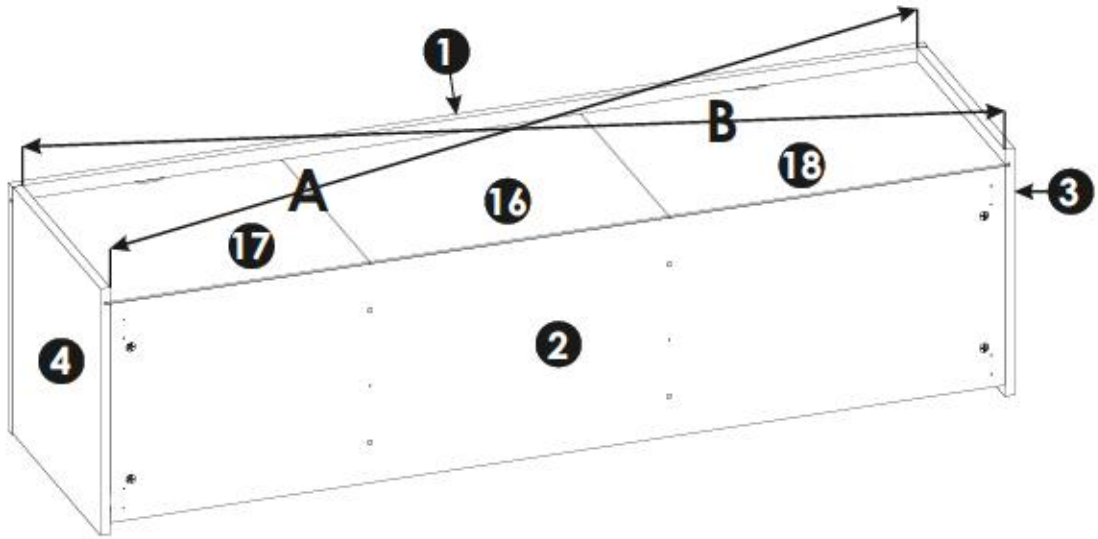



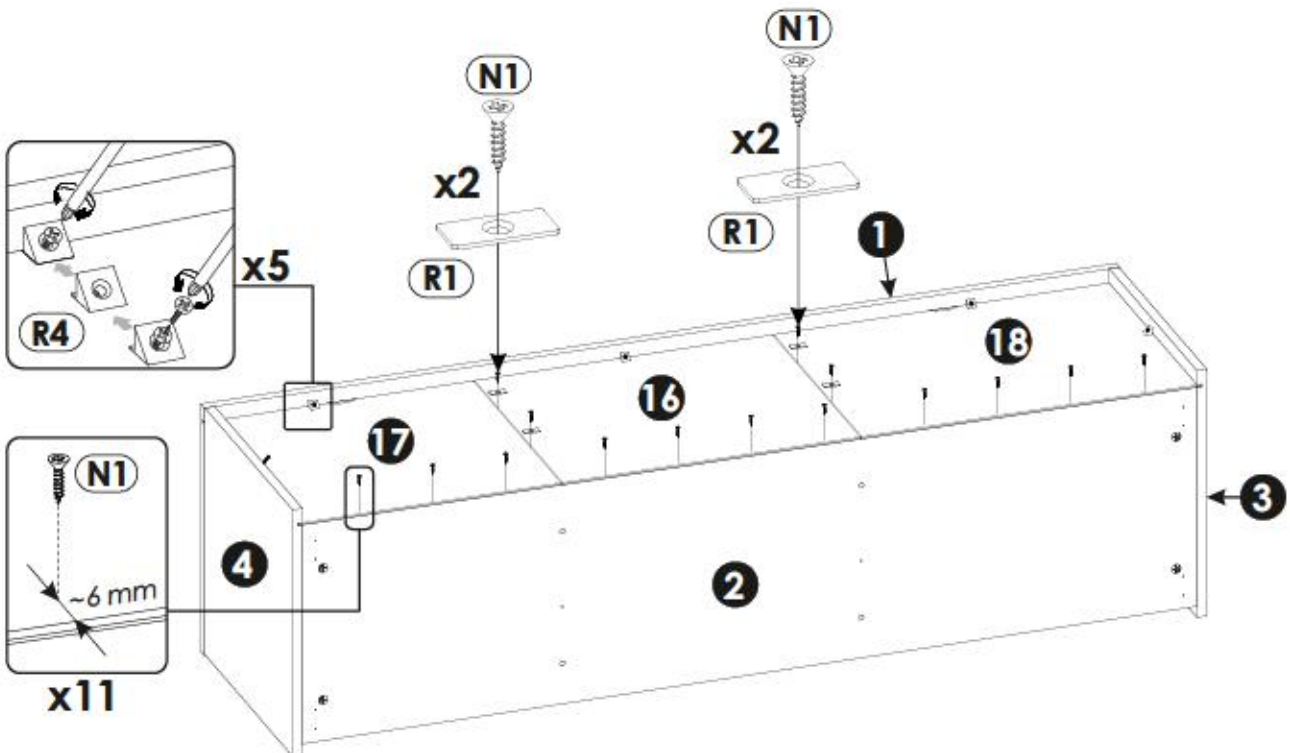
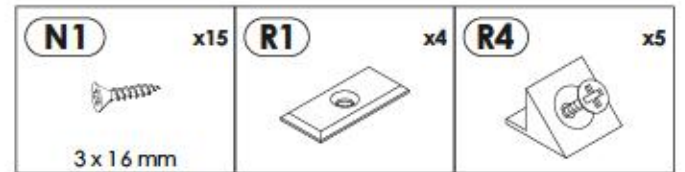
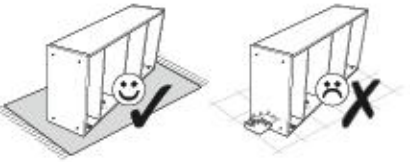

16 ▶

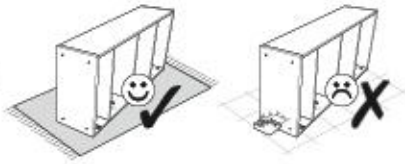

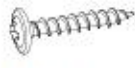
17▶



I3 x2  3,5 x 22 mm	O1 x2 	I13 x8  4 x 30 mm	O6 x4 
--	--	---	---

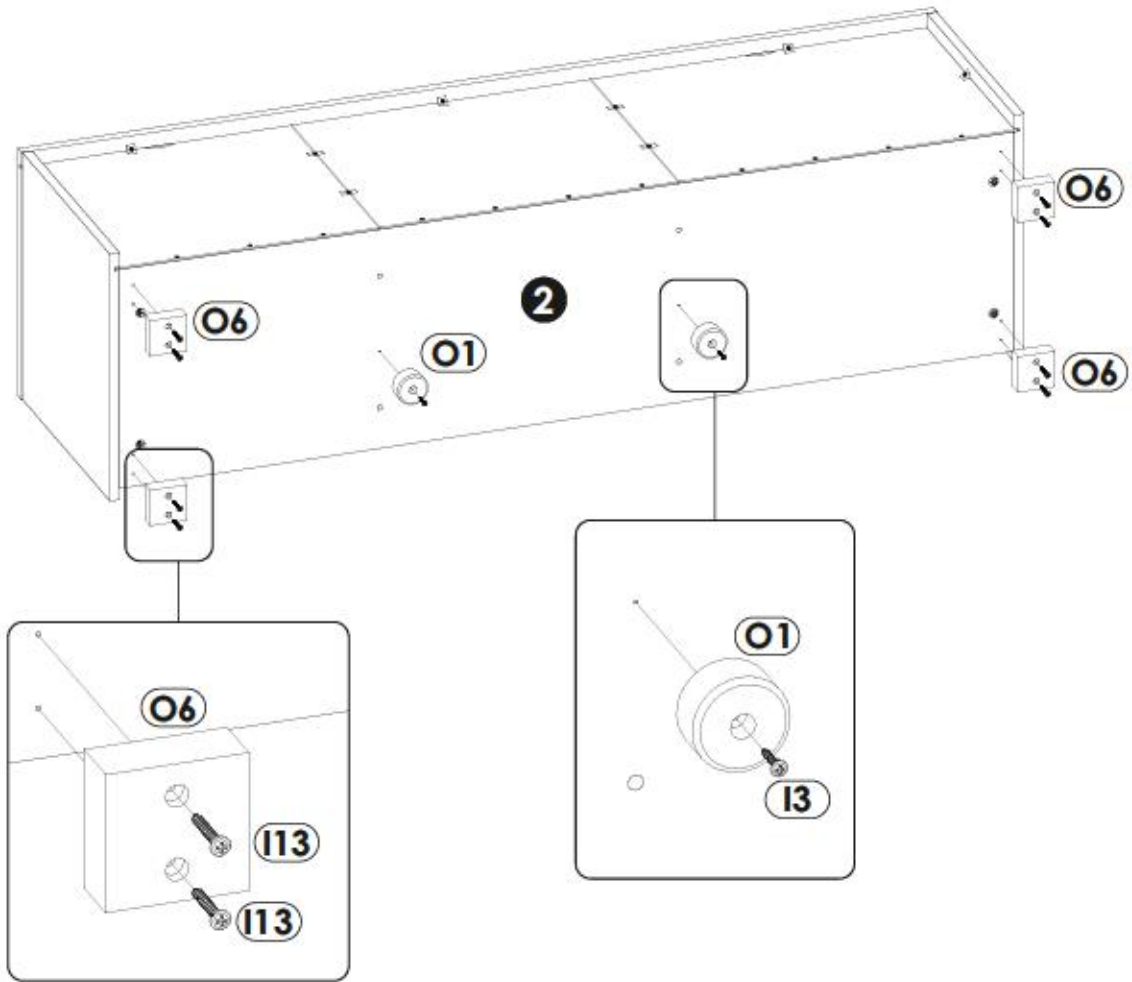

18▶

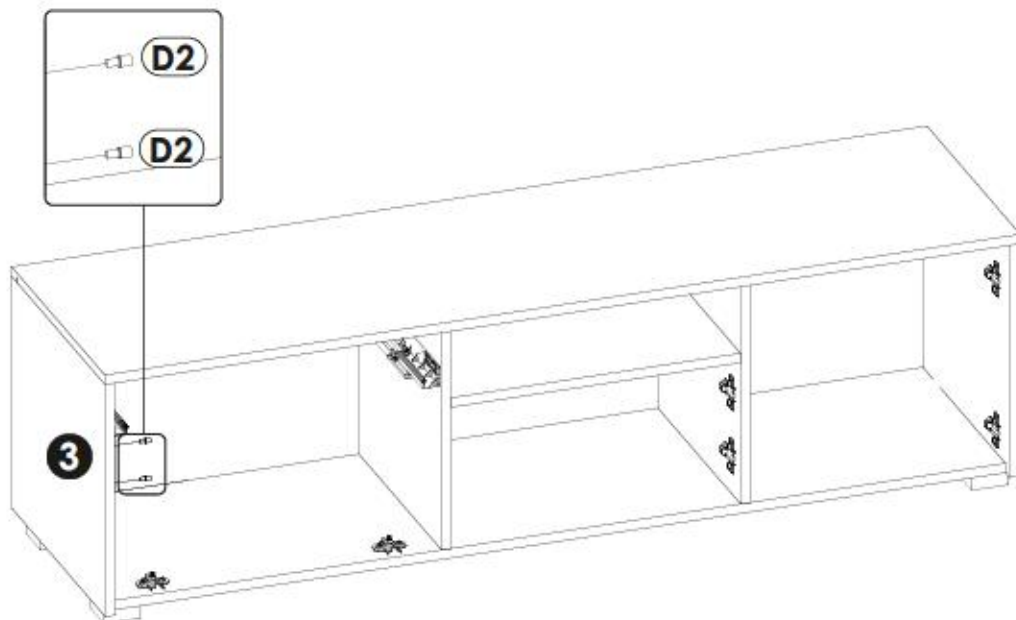

D2 x2 

19 ▶

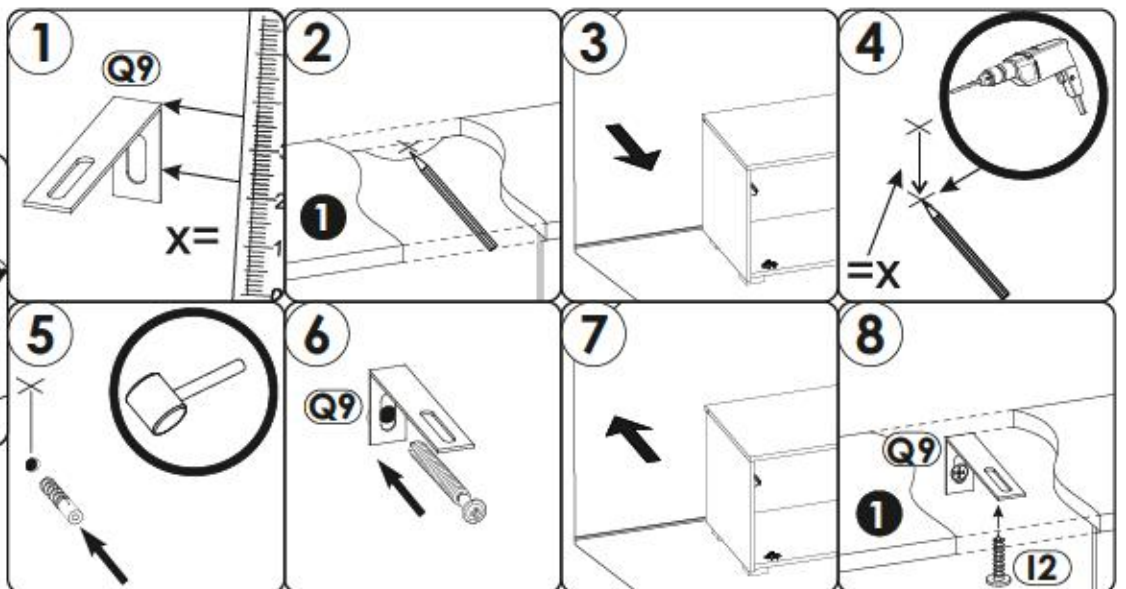
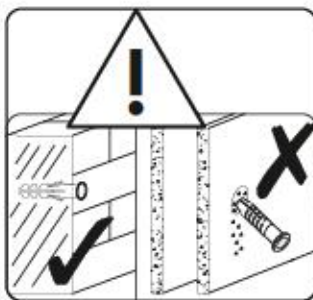
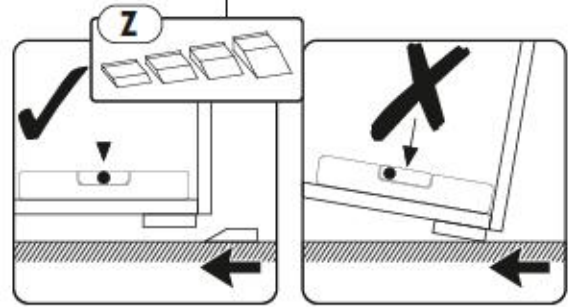
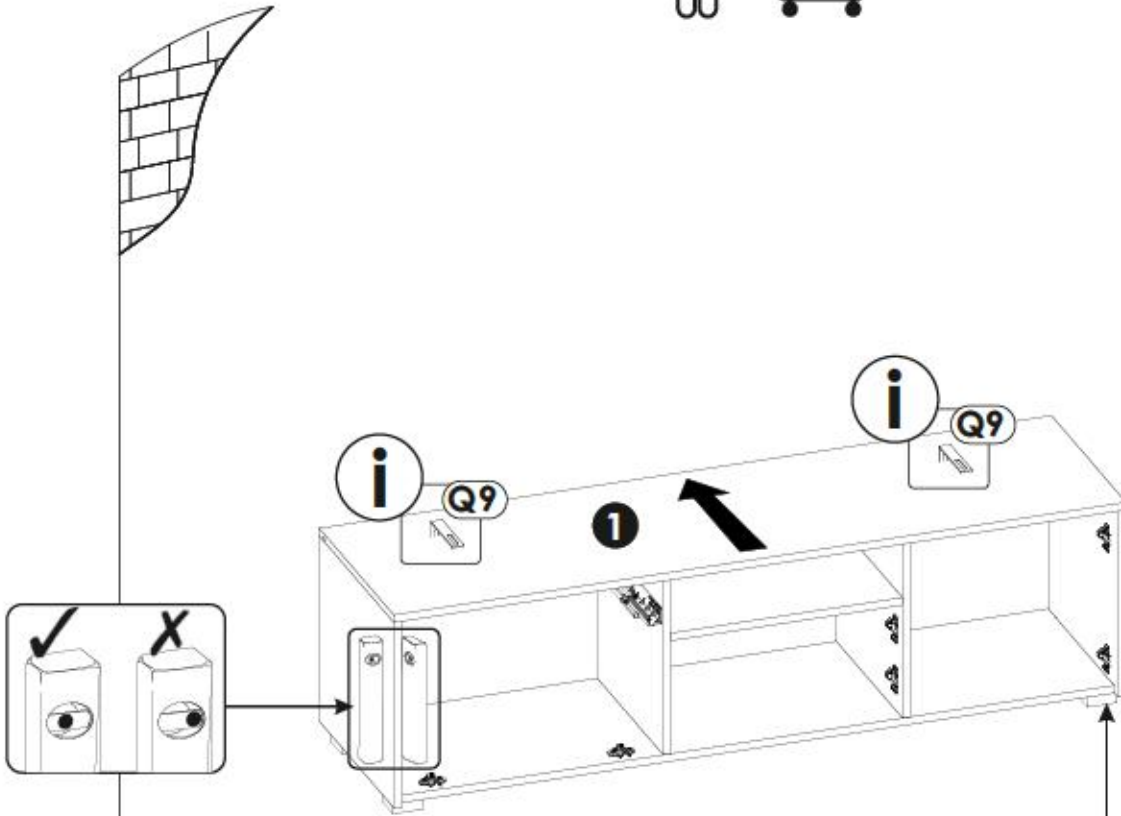
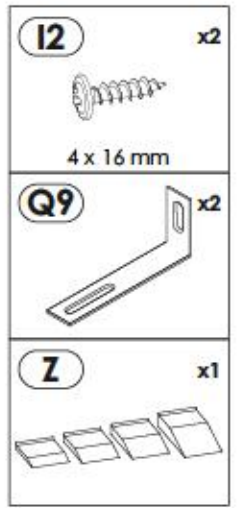

20 ▶

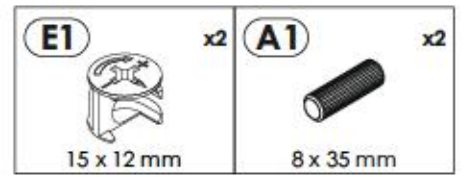

21 ▶

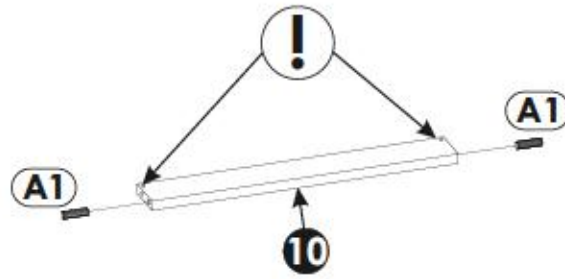

22 ▶

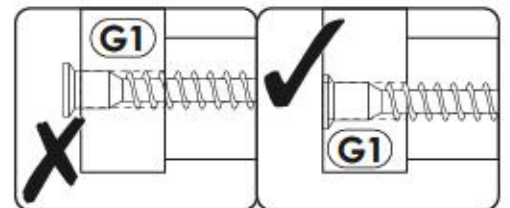
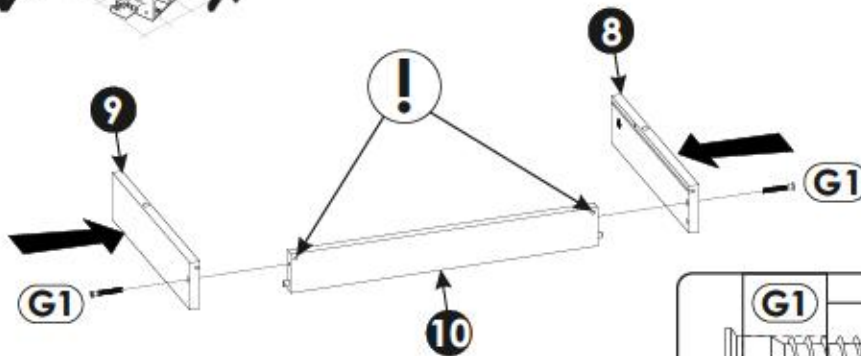
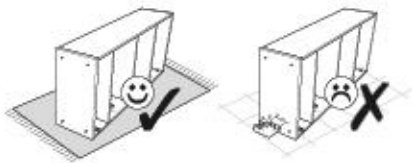

23 ▶

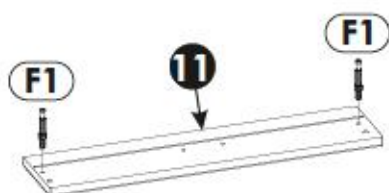
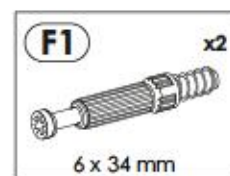

24 ▶

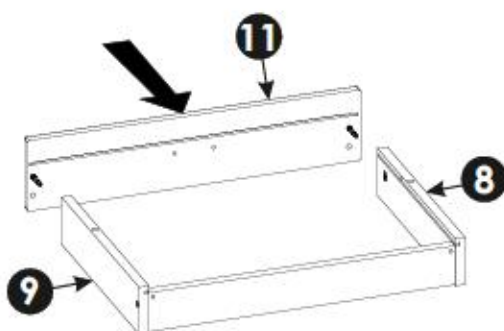
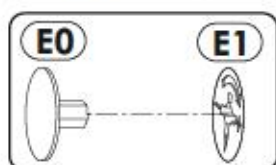
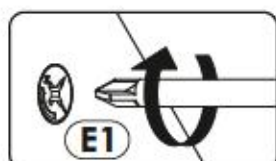
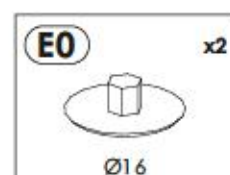
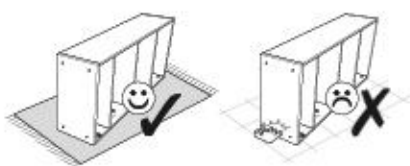

25 ▶

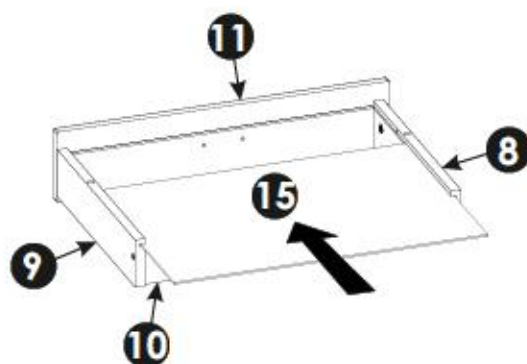
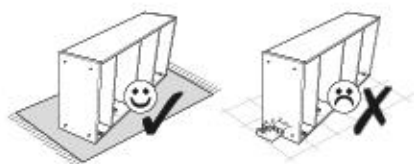

26 ▶

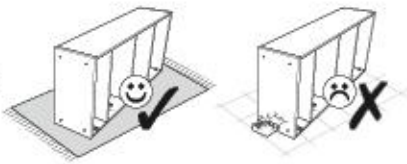

A=B

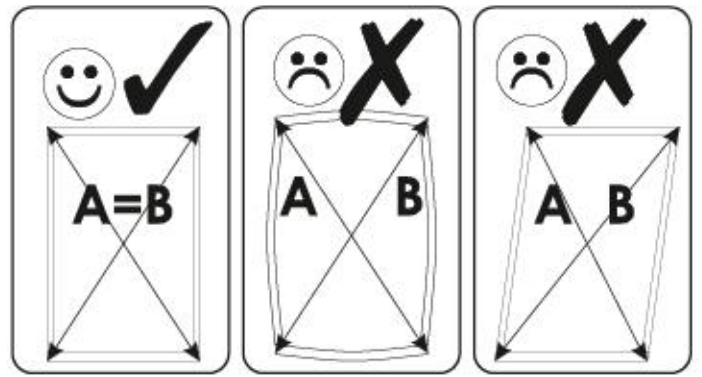
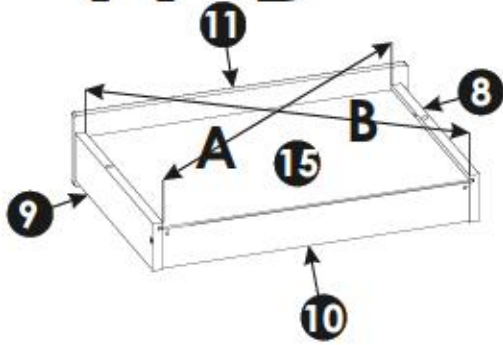

27 ▶

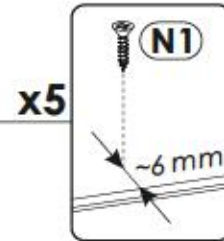
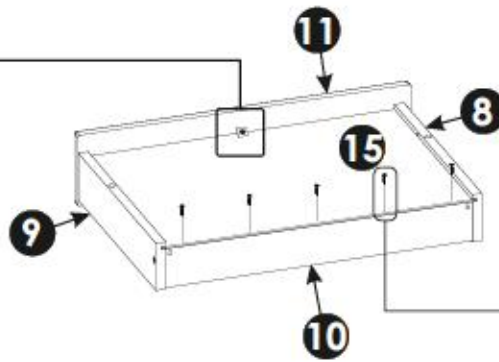
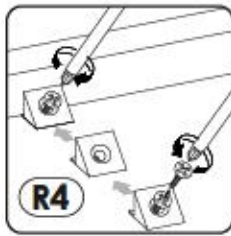
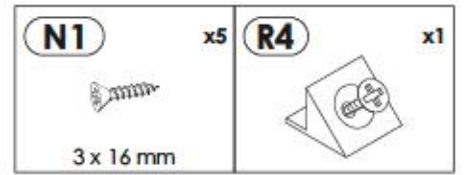
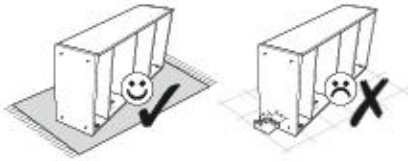

28 ▶

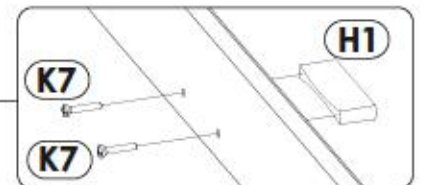
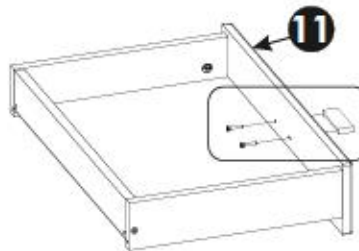
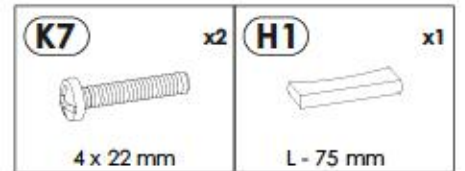
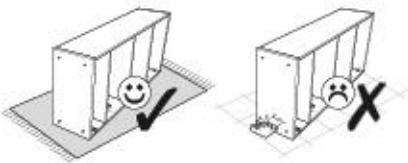

29 ▶

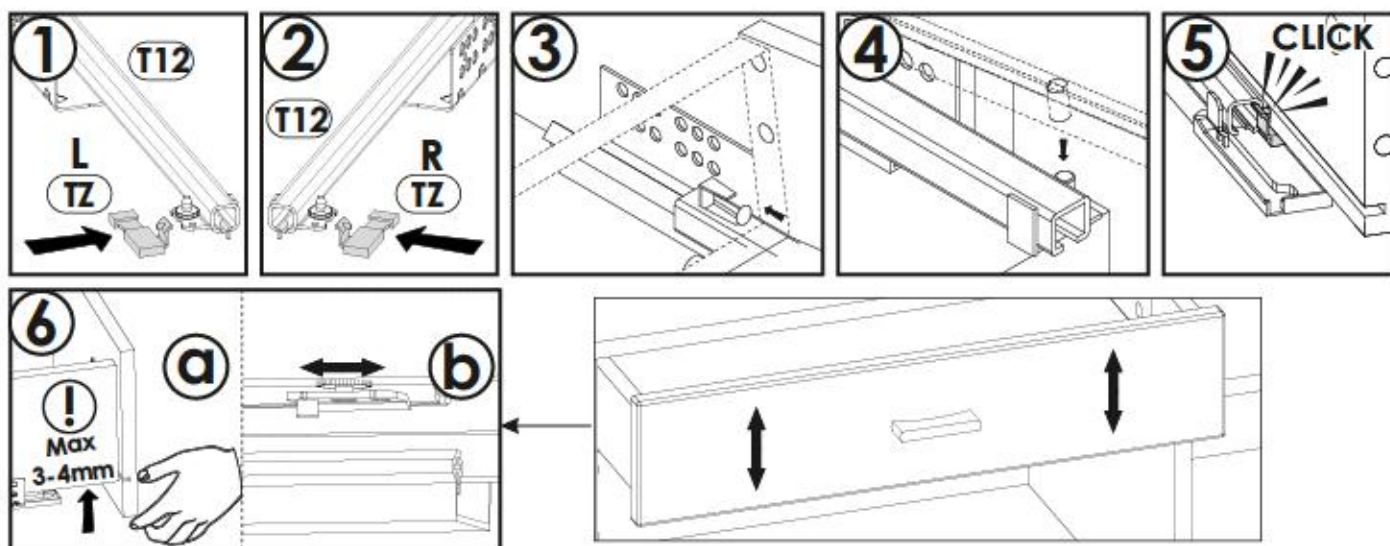
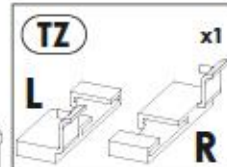
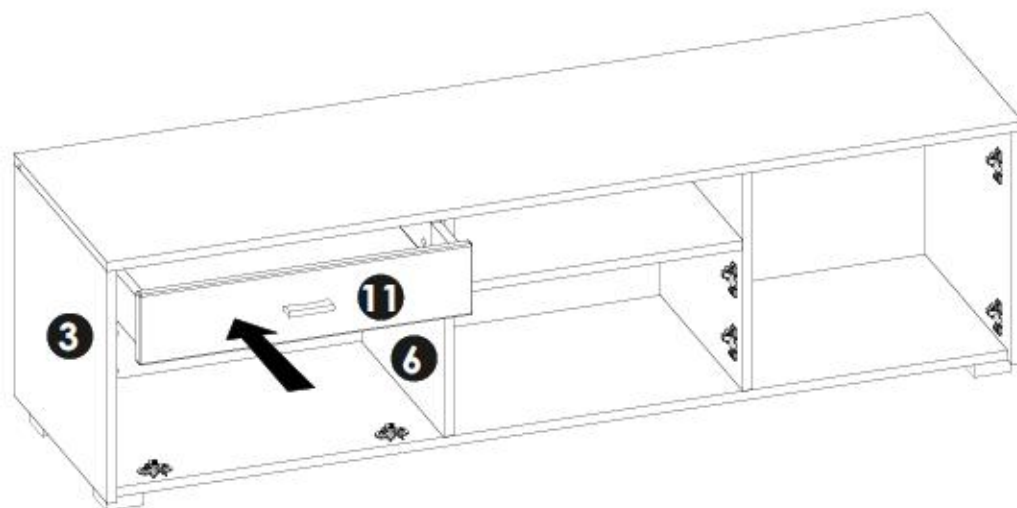

30 ▶

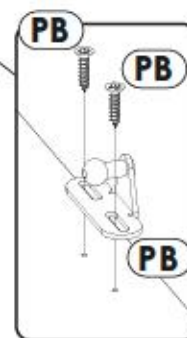
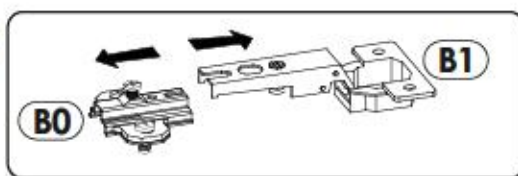
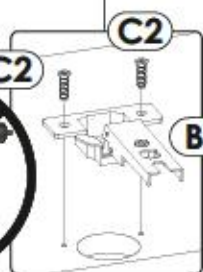
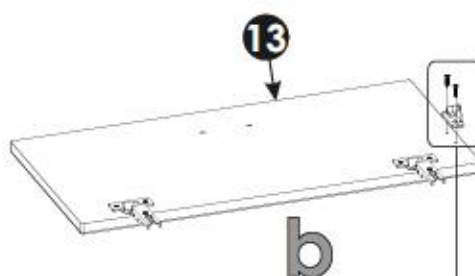
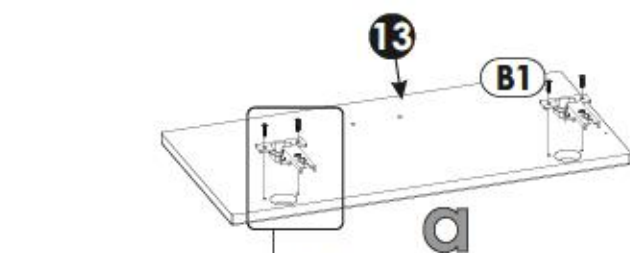
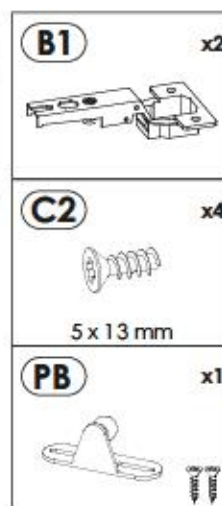

31▶

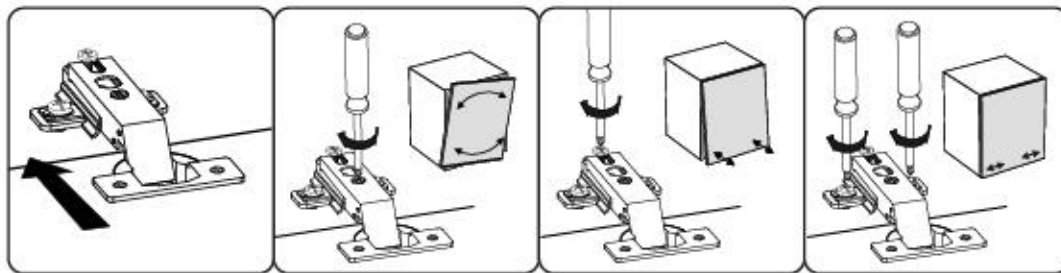
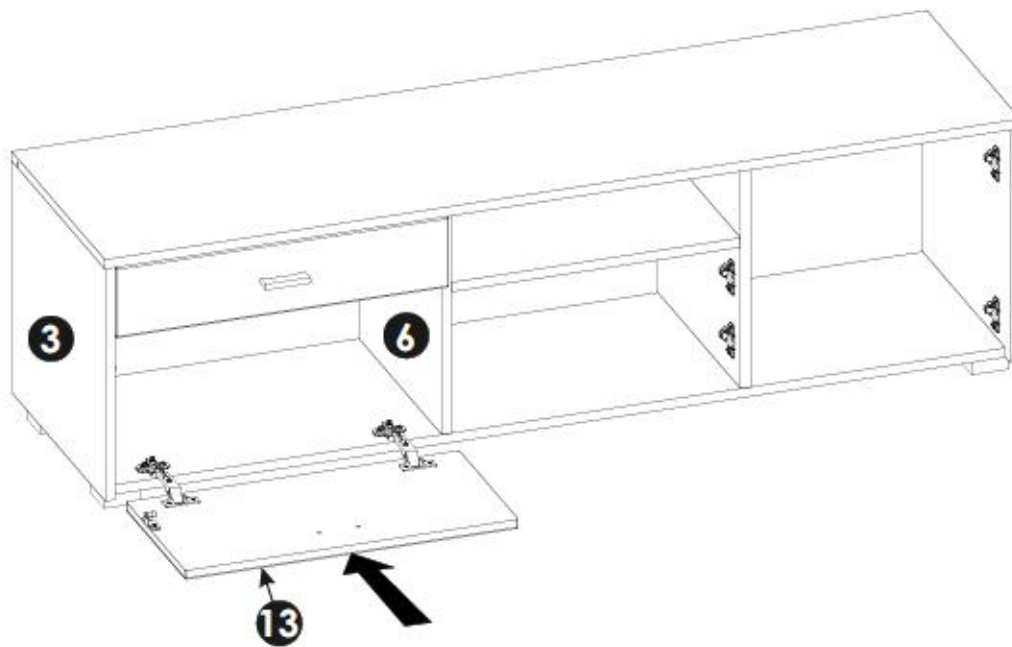

32▶

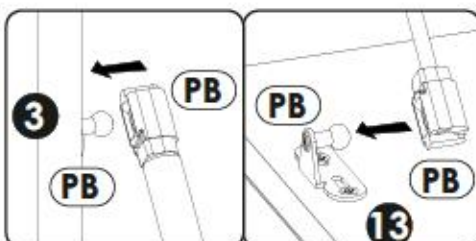
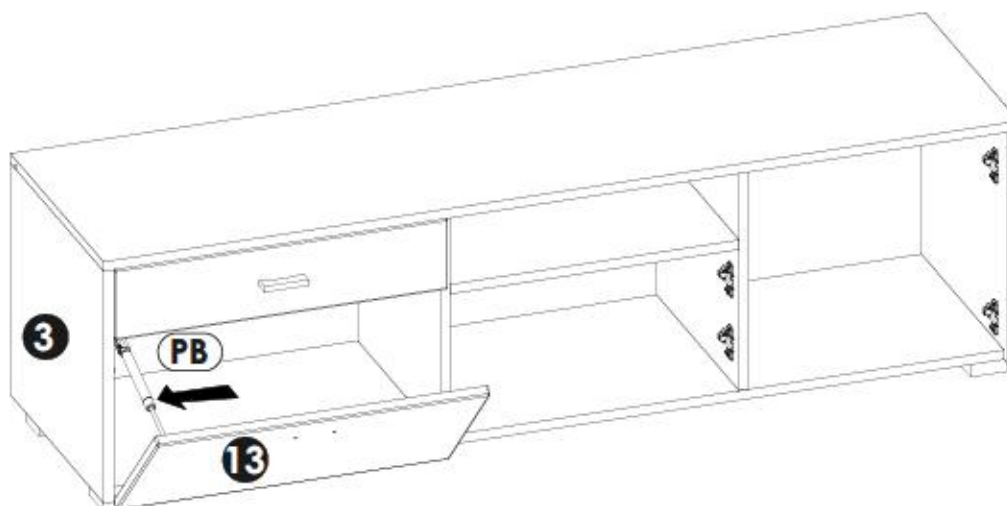
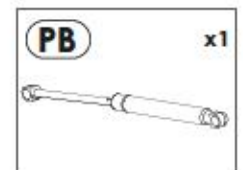

33▶

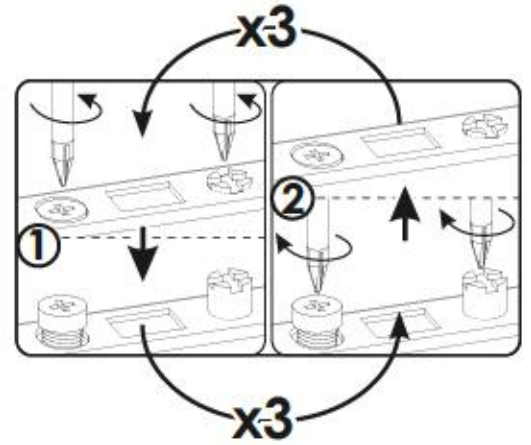
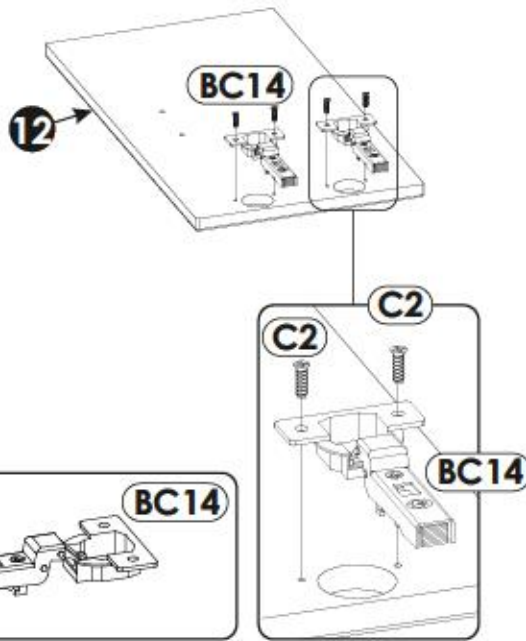
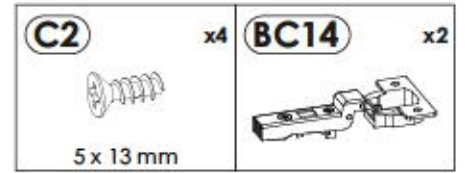

34▶

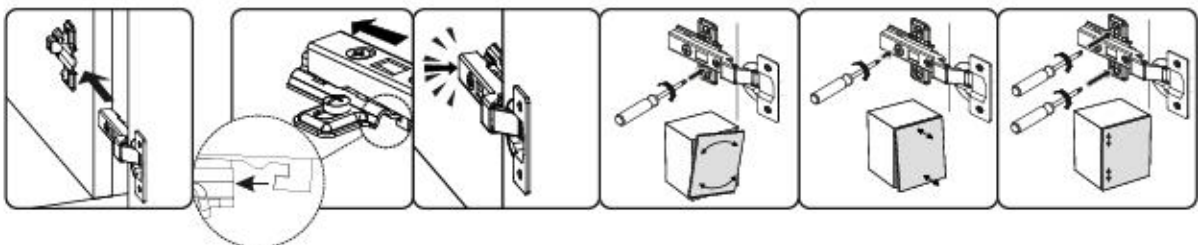
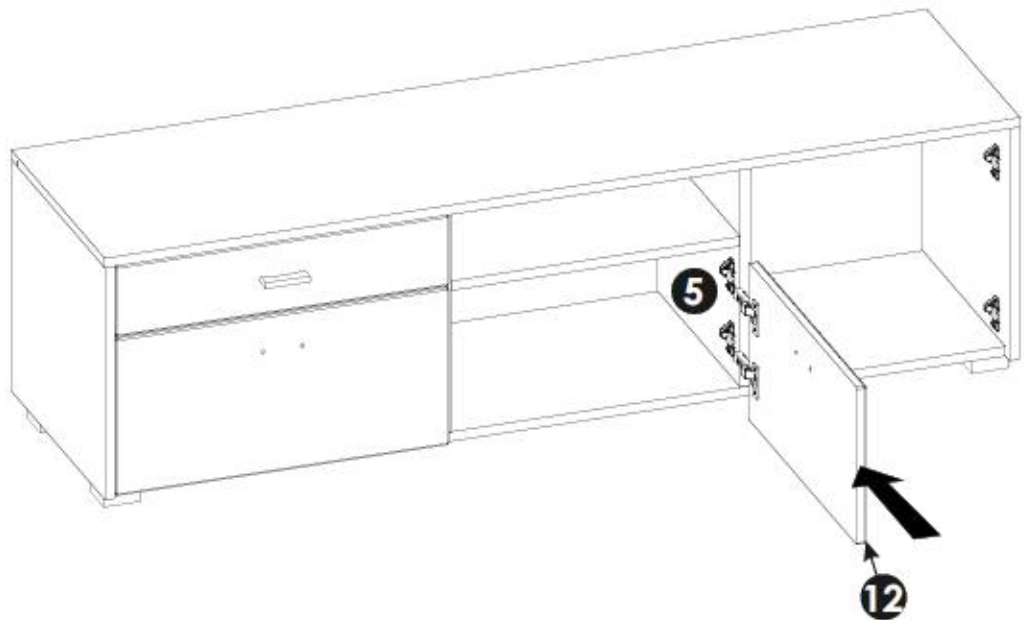

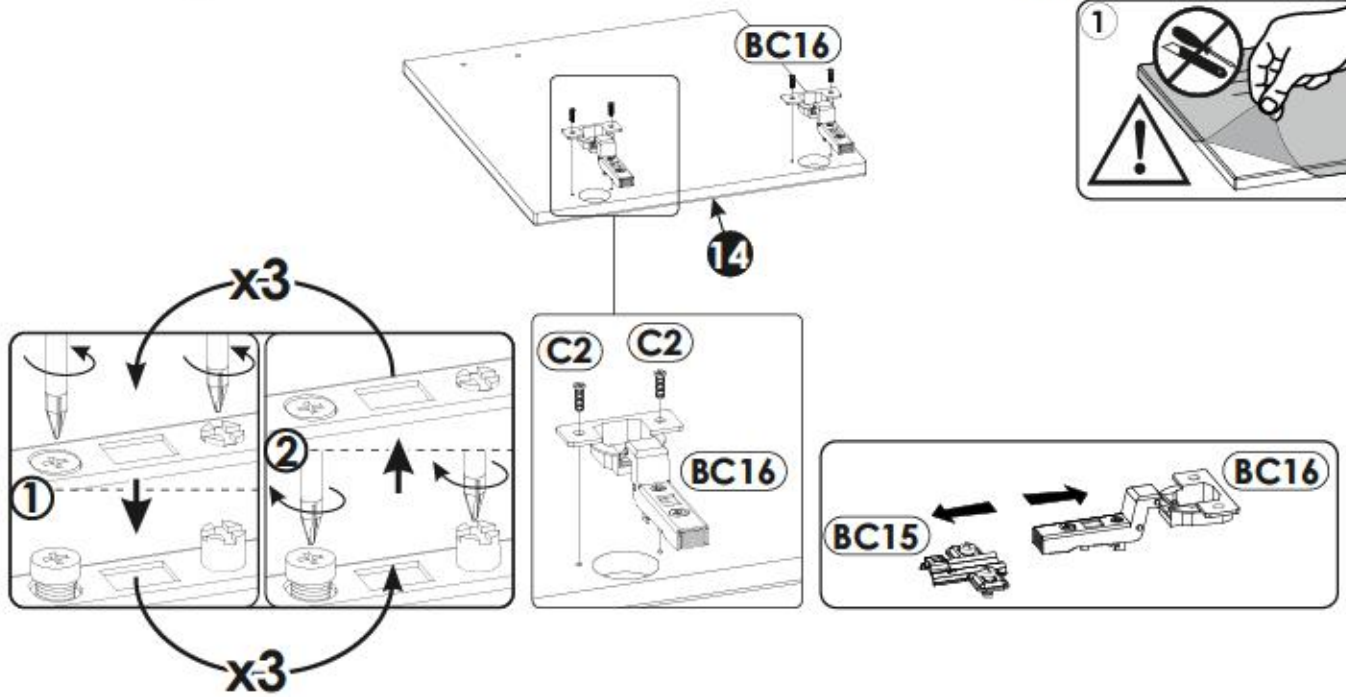
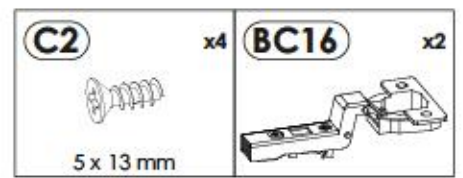

36 ▶

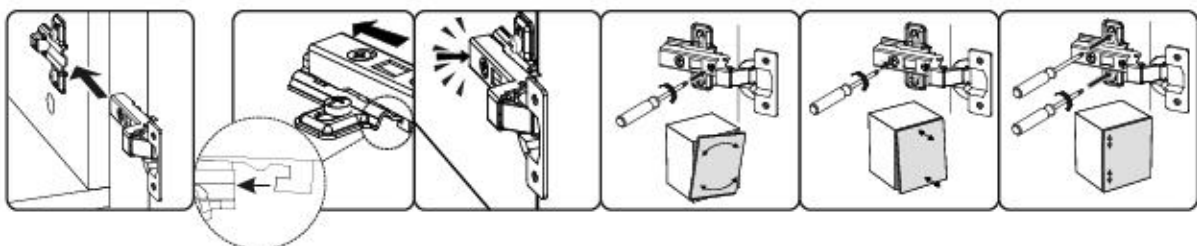
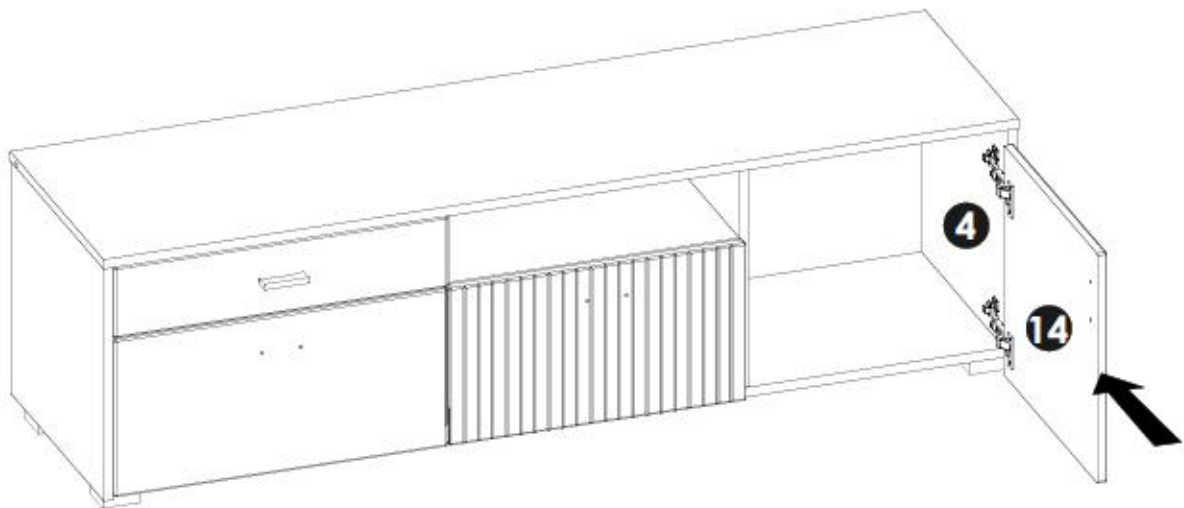

37▶

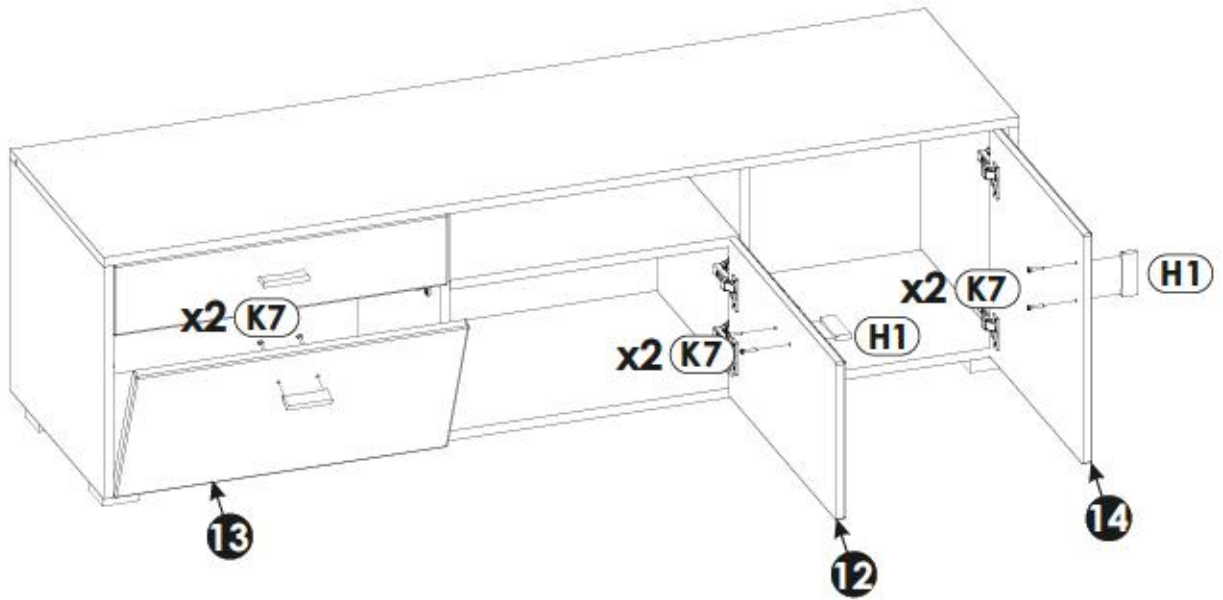
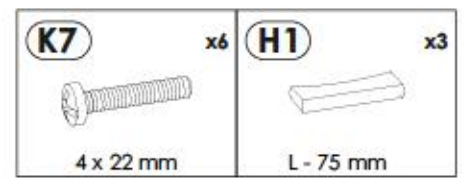

38▶

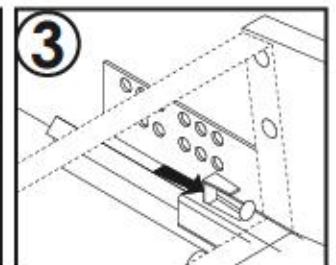
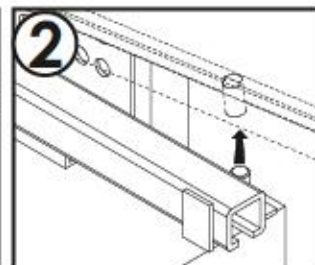
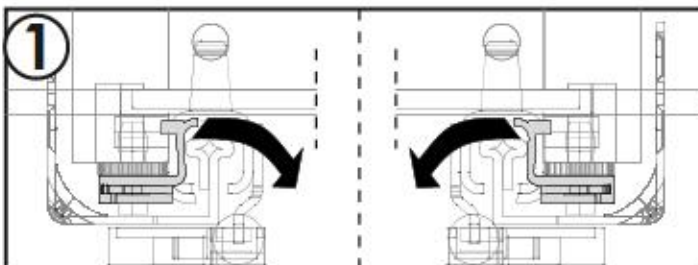
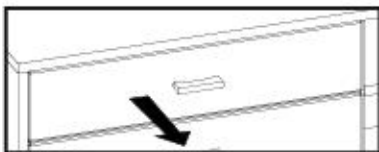
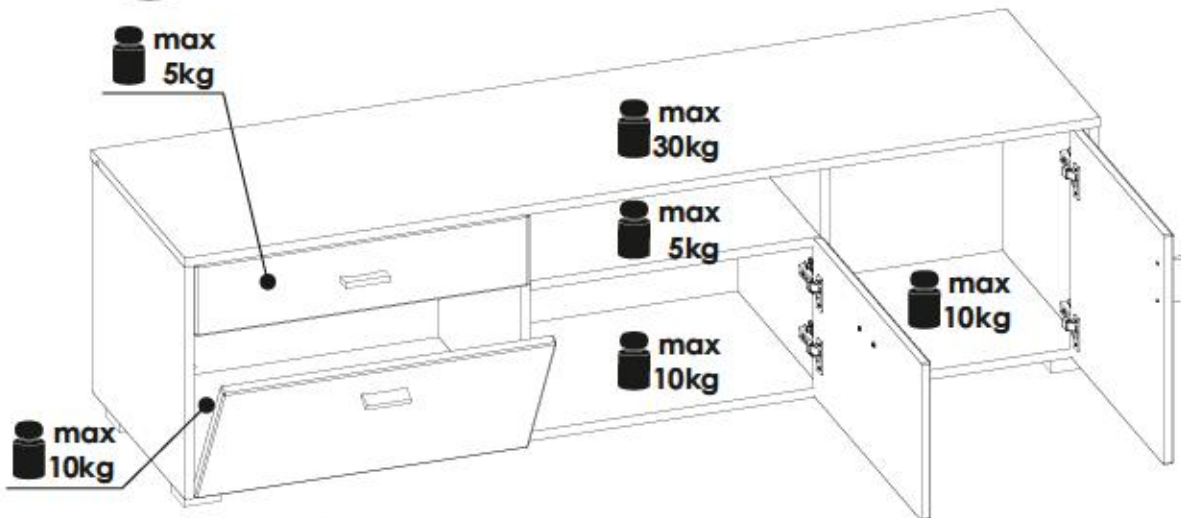

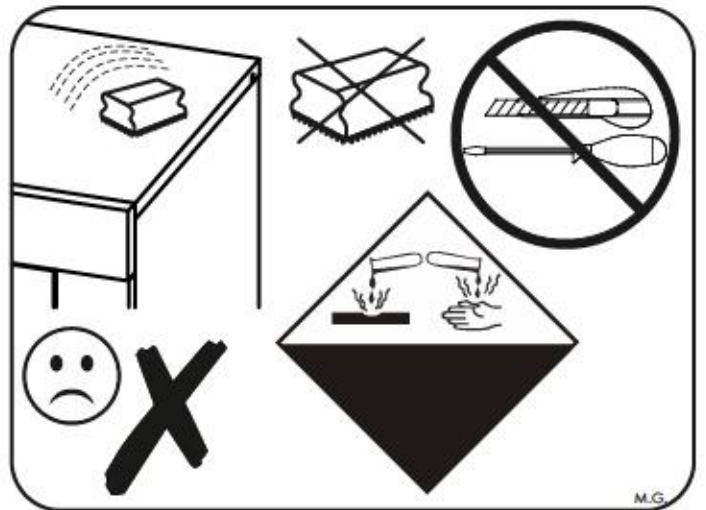
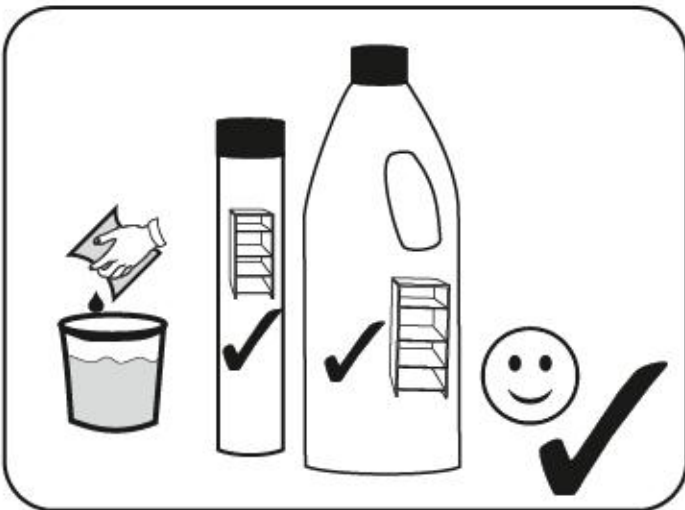
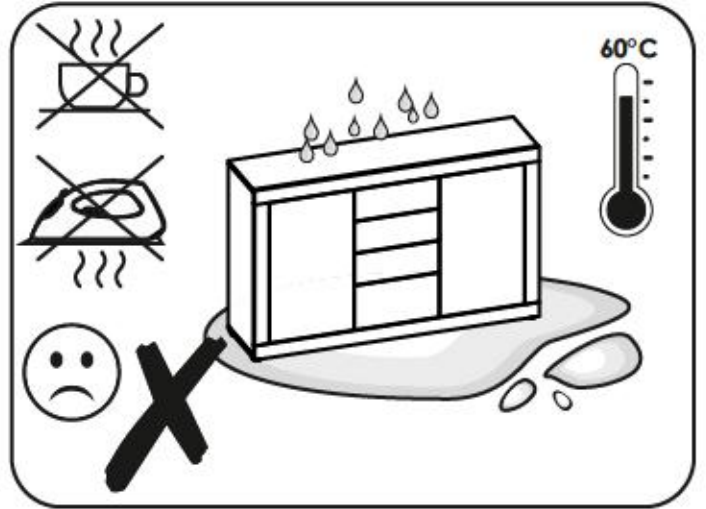
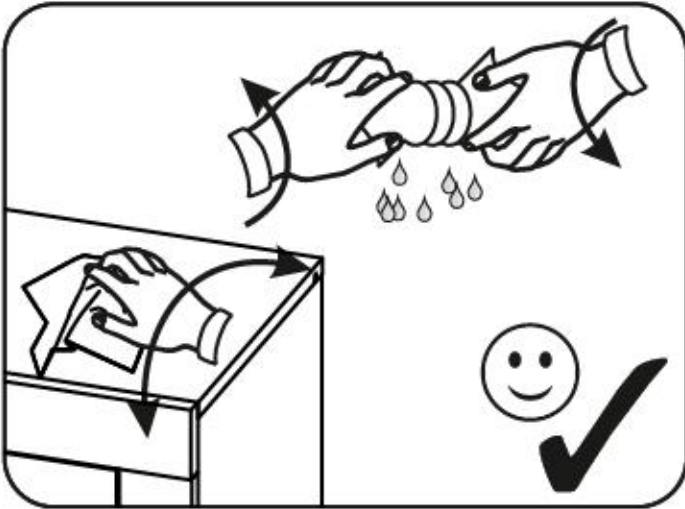
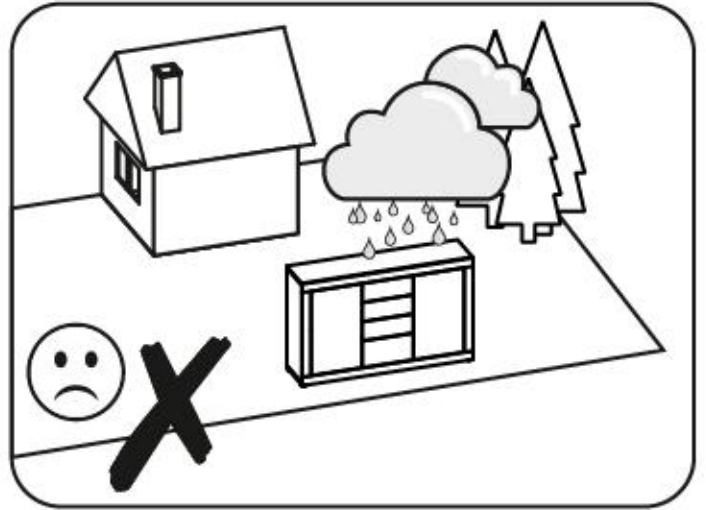
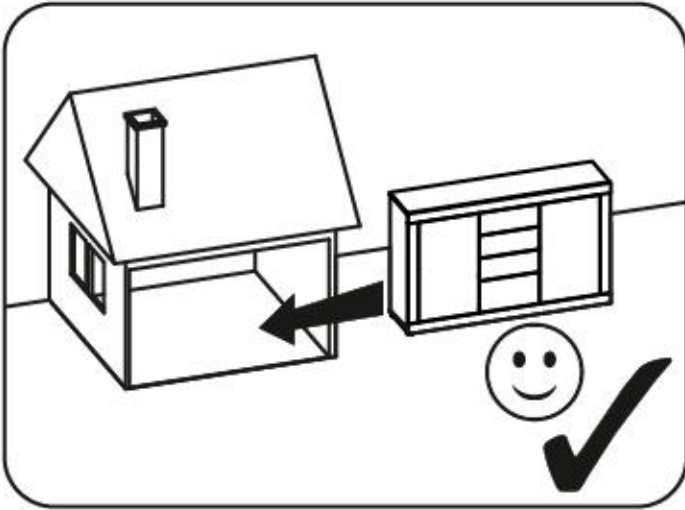

3WSEHU71/3WSYHU71



Ø5 Ø8

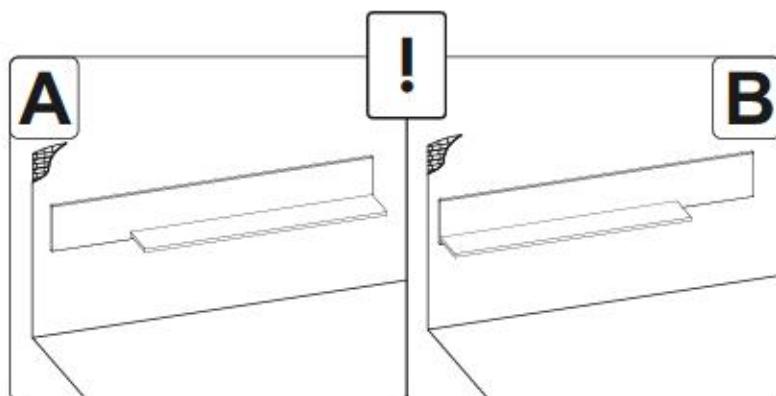

x1



x2

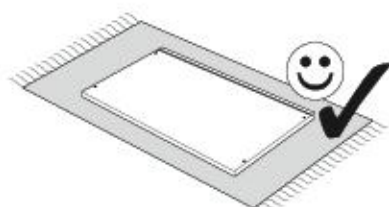
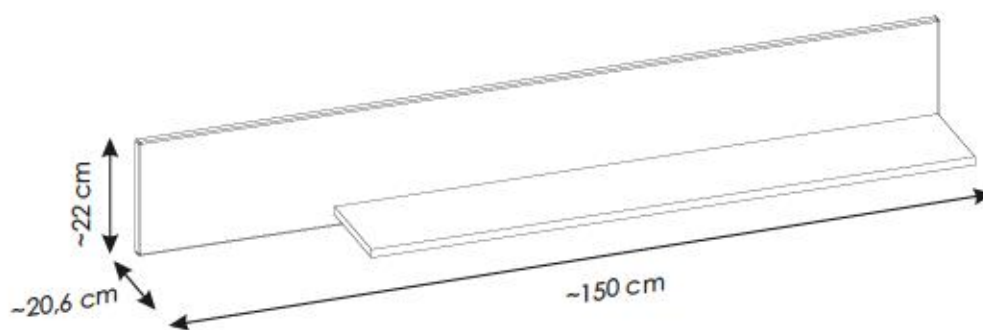

AR.

ملاحظة!

يجب تثبيت الأثاث بإحكام إلى الحائط أو الجدار لتجنب خطر إنقلابه. لا تحتوي العلبه على مسامير التثبيت، إذ إنه ينبغي إستعمال المسامير المخصصة لنوعية الحائط أو الجدار. اختر المسامير التي تناسب جدارك.

E.

¡ATENCIÓN! El mueble debe ser fijado permanentemente a la pared para evitar el riesgo relacionado con el vuelco del mueble. En el paquete no hay tornillos de fijación, ya que se debe elegir el tipo de fijación adecuado para el tipo de pared. Elija el apropiado para su tipo de pared.

CN.

注意！本家具需要固定在墙上以免倒塌。箱子里没有安装螺钉。因为安装方式需要根据墙的类型调整。请按照您的墙类型选择合适的安装方式。

SLO.

POZOR! Pohištvo trajno pritrđite na steno, da preprečite tveganje, da se prevrne. V paketu ni pritrđilnih vijakov, saj je treba način pritrđitve ustrezno izbrati glede na vrsto stene. Izberite način, ki je ustrezen za vašo steno.

HU.

FIGYELEM! Rögzítse a bútorokat a falhoz, hogy elkerülje a bútor felborulásának kockázatát. A készletben nem találhatóak rögzítőcsavarok, mivel a rögzítés típusa a fal típusától függ. Válassza ki a fal típusának megfelelő kötőelemeket.

NL.

OPMERKING! De meubelen moeten permanent aan de muur worden bevestigd om te voorkomen dat de meubelen kantelen. Er zitten geen bevestigingsschroeven in het pakket, omdat het type bevestiging moet worden gekozen op basis van het type muur. Kies de juiste voor uw type muur.

EN.

WARNING! To prevent this furniture from tripping over, fix it to the wall permanently. Fixing devices are not included since different wall materials require different types of fixing devices. Please make sure you chose the correct ones for your type of wall.

SK.

POZORI Nábytok musí byť trvalo pripevnený k stene tak, aby sa zamedzilo riziku prevrátenia. Balík neobsahuje upevňovacie skrutky, pretože typ upevnenia je treba vybrať podľa typu steny. Vyberte typ vhodný pre Vašu stenu.

CZ.

POZORI Nábytek je nutné pevně připevnit ke zdi, abychom se vyhnuli riziku spojenému s jeho převrnutím. Součástí balení nejsou připevňovací šrouby, protože způsoby připevnění je nutné zvolit podle druhu stěny. Vyberte správný pro Váš typ stěny.

RU.

ПРИМЕЧАНИЕ! Эту мебель необходимо всегда прикреплять к стене, чтобы избежать рисков, связанных с переворотом мебели. В пакете нет крепежных винтов, потому что тип крепления должен быть выбран в соответствии с типом стены. Выберите, пожалуйста, правильные винты к вашей стене.

RO.

ATENȚIE! Mobila trebuie ancorată permanent în perete pentru a evita riscul de răsturnare a mobilei. În pachet nu sunt incluse șuruburile de fixare, deoarece tipul de ancoraj trebuie ales în funcție de tipul de perete. Alegeți șuruburile potrivite pentru tipul Dvs. de perete.

TR.

DIKKAT! Devrimle riskini önlemek için mobilya duvara sabitlenmelidir. Sabitleme civataları pakete dahil değildir, çünkü sabitleme tertibatının tipi, duvara tipine uygun olarak seçilmelidir. Onu duvannızın tipine göre seçiniz.

PL.

UWAGA! Mebel należy trwale zamocować do ściany, aby uniknąć ryzyka związanego z przewróceniem się mebla. W paczce nie ma śrub mocujących, ponieważ rodzaj mocowania należy odpowiednio dobrać do rodzaju ściany. Dobierz właściwe do Twojego rodzaju ściany.

D.

ACHTUNG! Um alle mit dem Umkippen des Möbels verbundenen Risiken auszuschließen, muss das Möbel fest an der Wand verankert werden. Beschläge für die Wandbefestigung sind nicht beige packt, da diese von der jeweiligen Wandbeschaffenheit abhängig sind. Bitte solche Befestigungsschläge wählen, die für die heimischen Wände geeignet sind.

FR.

ATTENTION! Ce meuble doit être fixé en permanence au mur pour éviter les risques de chute. Les vis de fixation ne sont pas livrées car le type de fixation doit être choisi en fonction du type de mur. Sélectionnez les fixations adaptées au mur.

I.



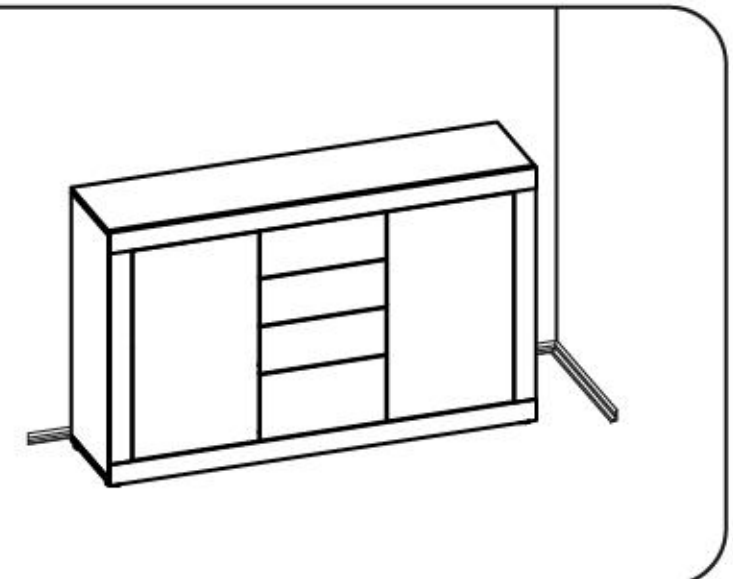
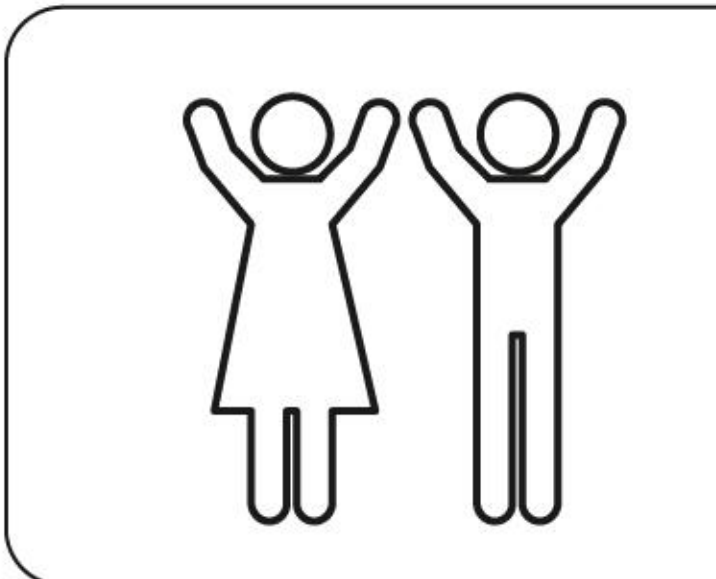
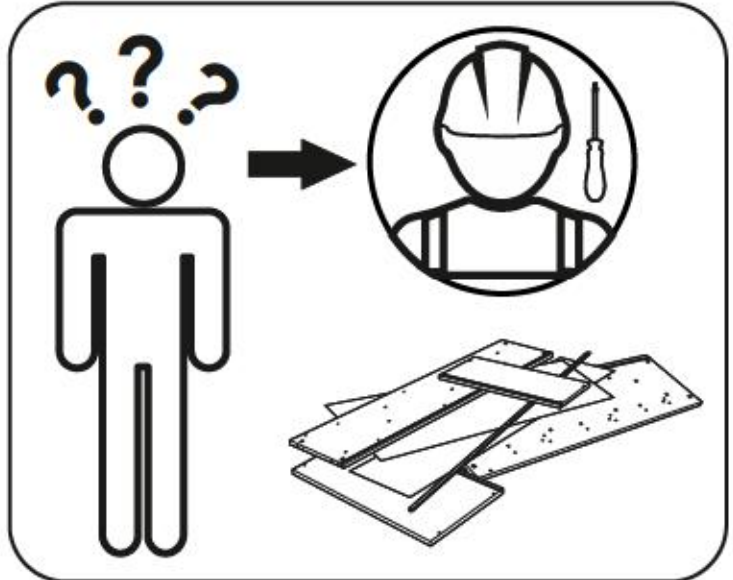
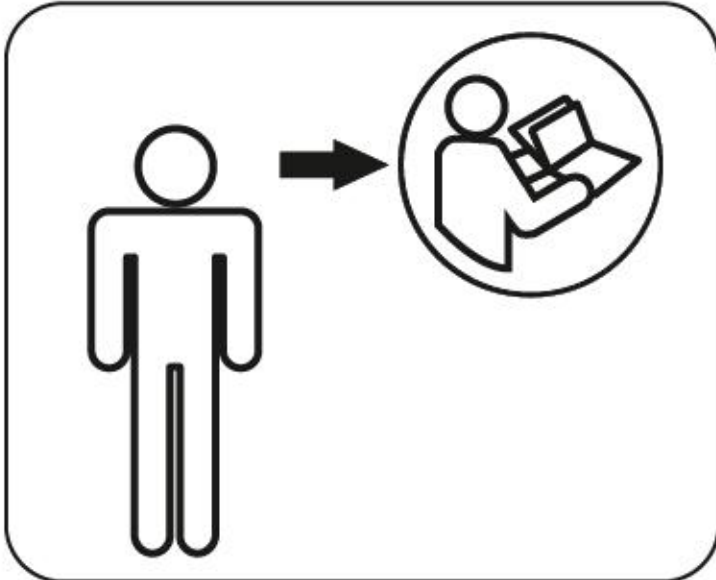
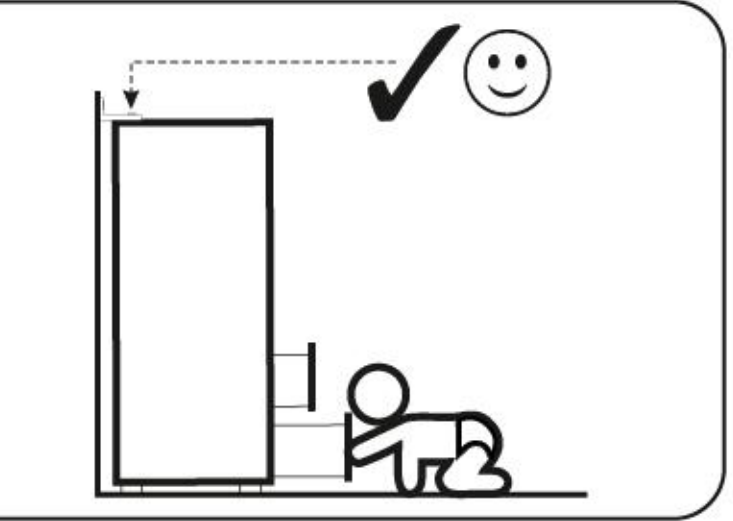
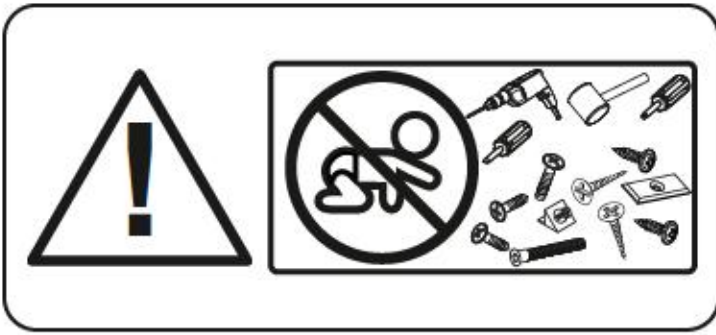

ATTENZIONE! Il mobile deve essere permanentemente fissato alla parete per evitare i rischi derivanti da un ribaltamento del mobile. La confezione non include le viti di fissaggio, in quanto il tipo di fissaggio deve essere scelto in base al tipo di parete. Utilizzare viti appropriate in base al materiale della parete.

HR.

NAPOMENA! Namještaj mora biti trajno pričvršćen za zid, kako bi se izbjegao rizik od njegovog prevrtanja. U paketu nema vijaka za pričvršćivanje, jer se vrsta montaže mora prilagoditi vrsti zida. Odaberite pravu vrstu prema Vašoj vrsti zida.

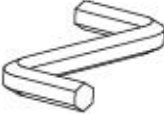

3WSEHU71/3WSYHU71

A1 8 x 35 mm x6 	C2 5 x 13 mm x4 	G2 7 x 60 mm x3 
M  x1	P1  x2	R7  x2

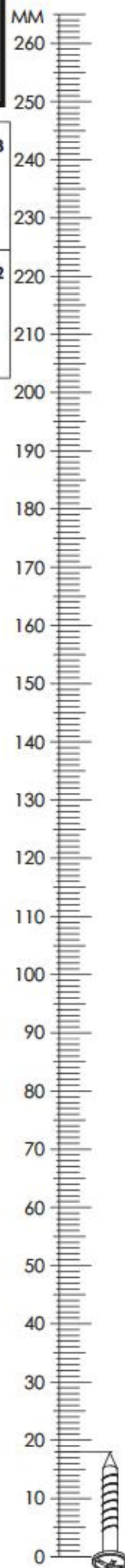

3WSEHU71/3WSYHU71

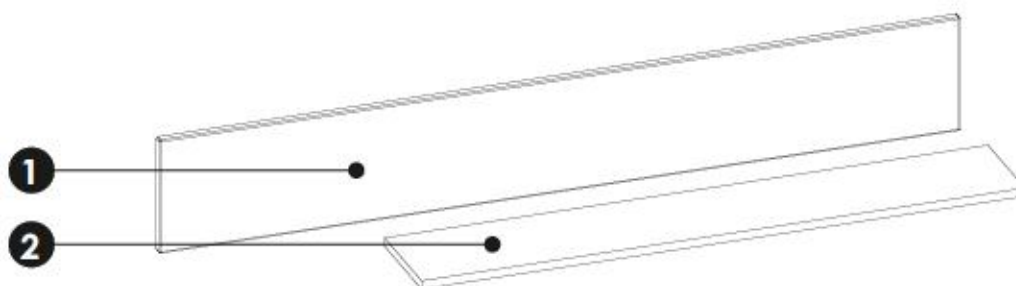

1	1500	220	16	x1	1/1
2	1130	190	16	x1	1/1

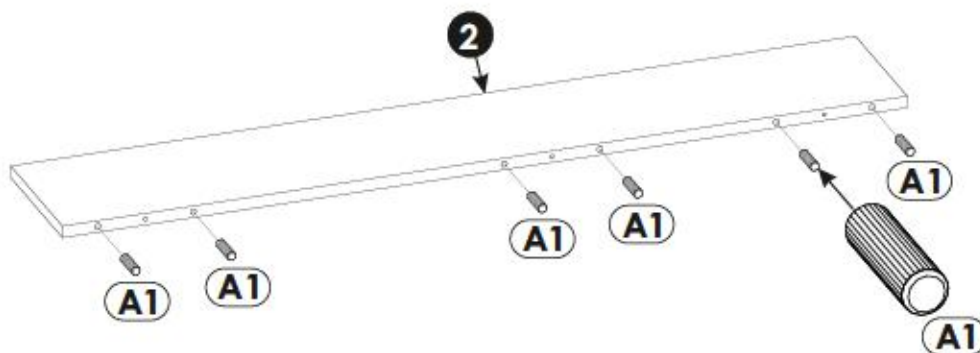
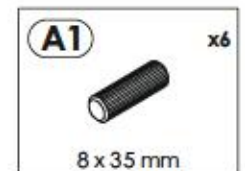
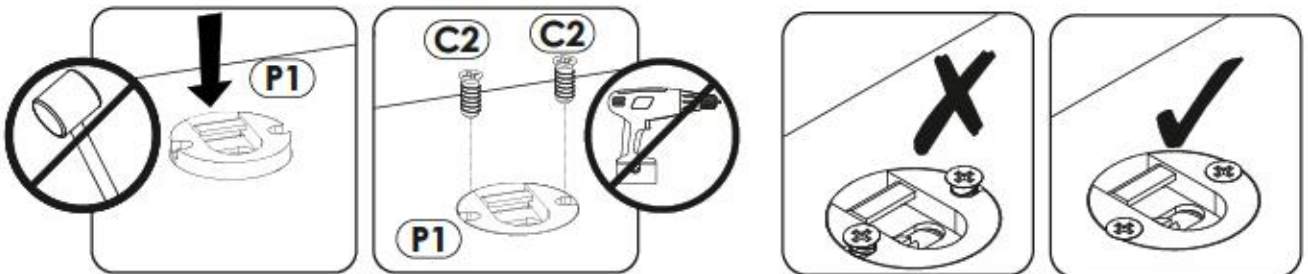
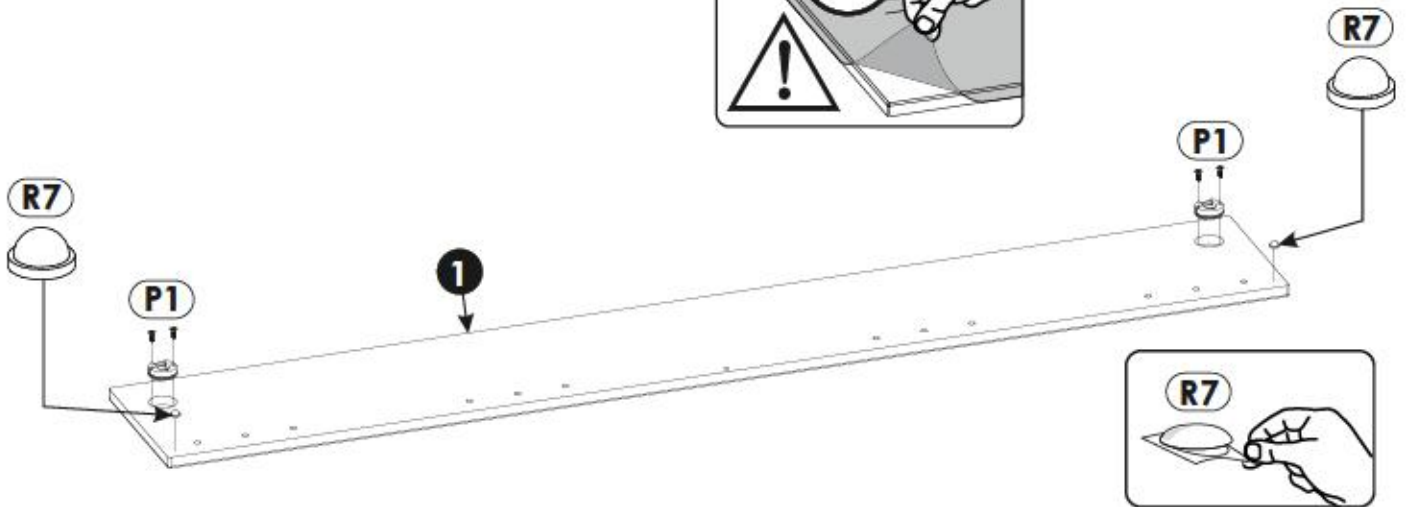
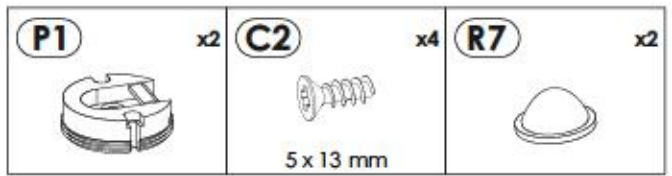

3 ▶

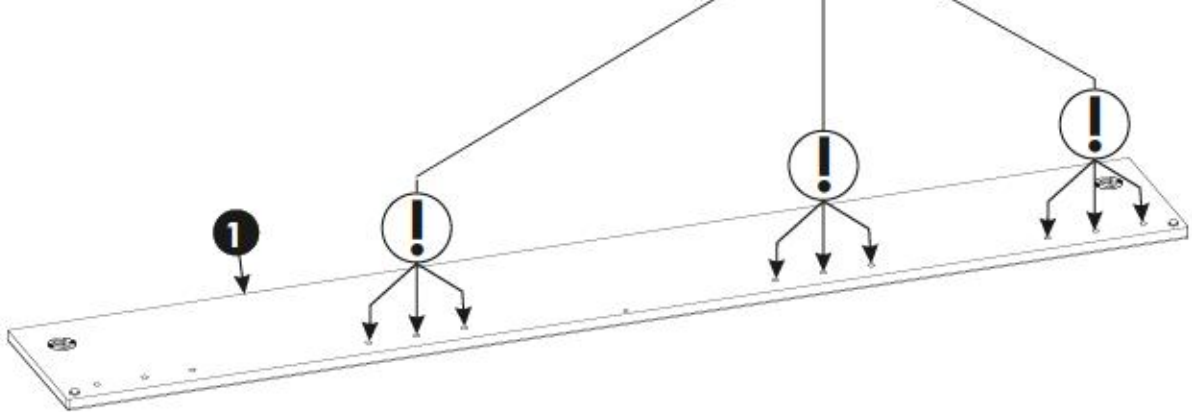
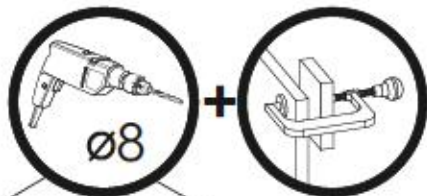
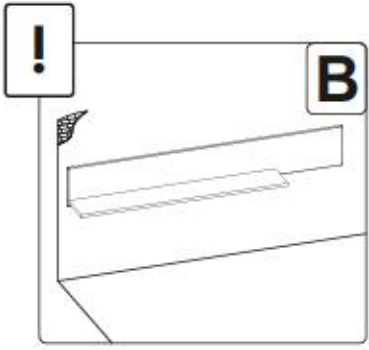
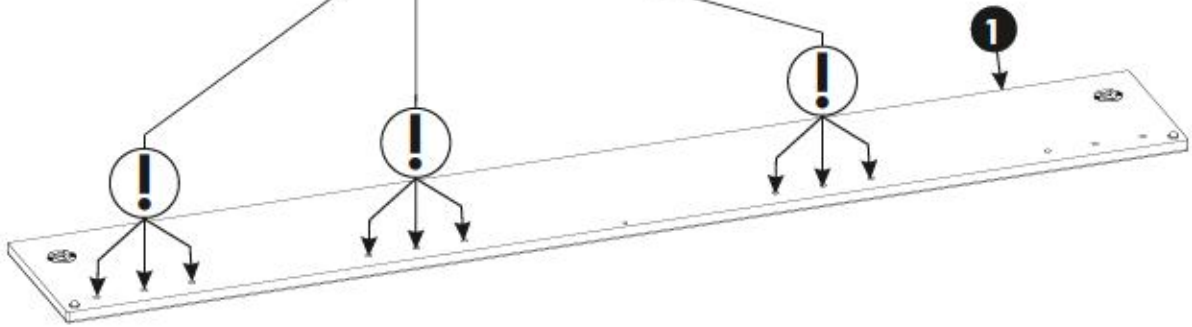
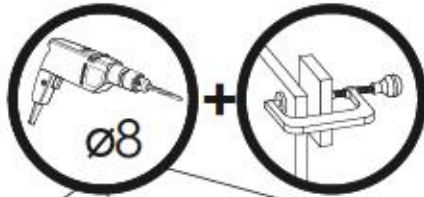
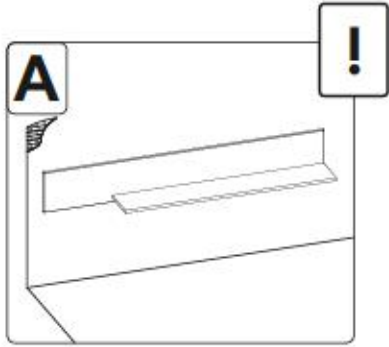

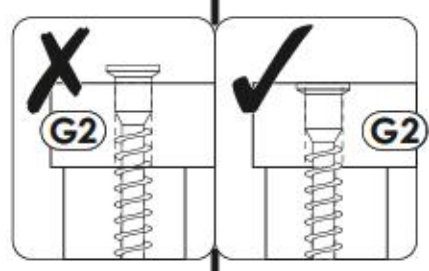
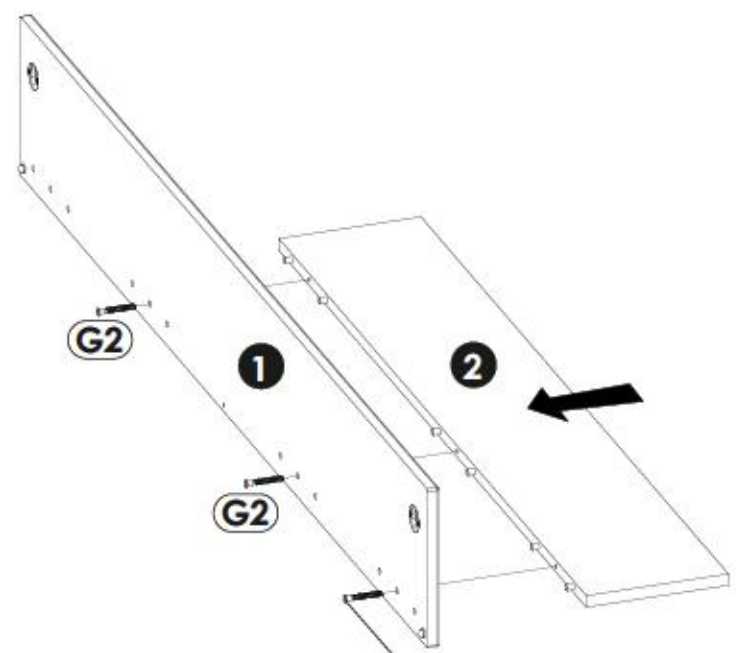
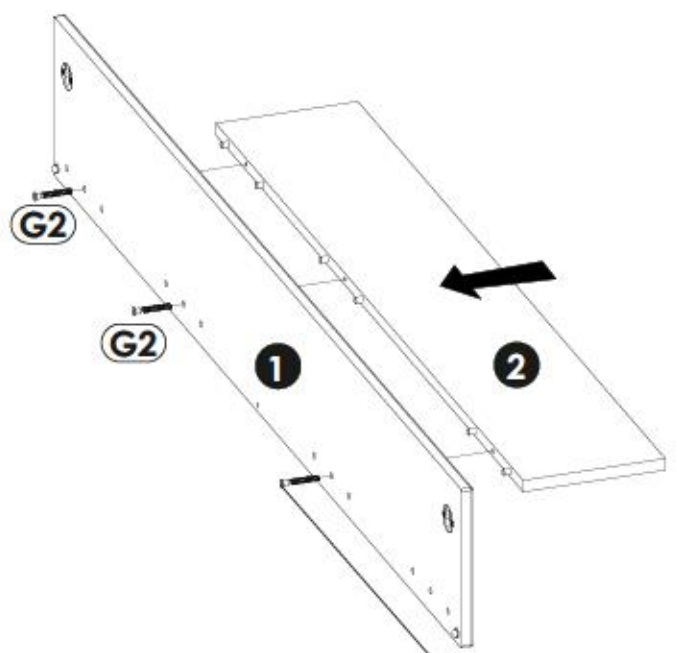
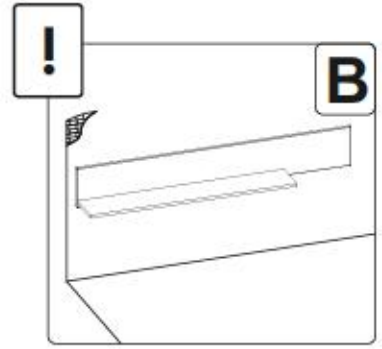
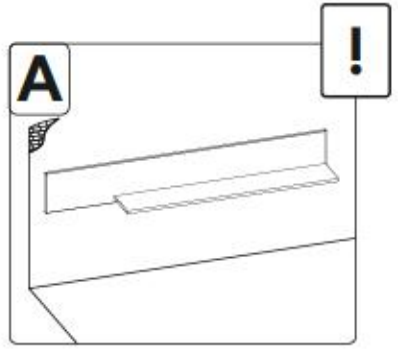
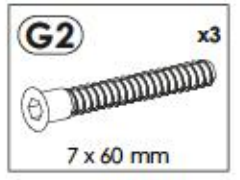

5 ▶

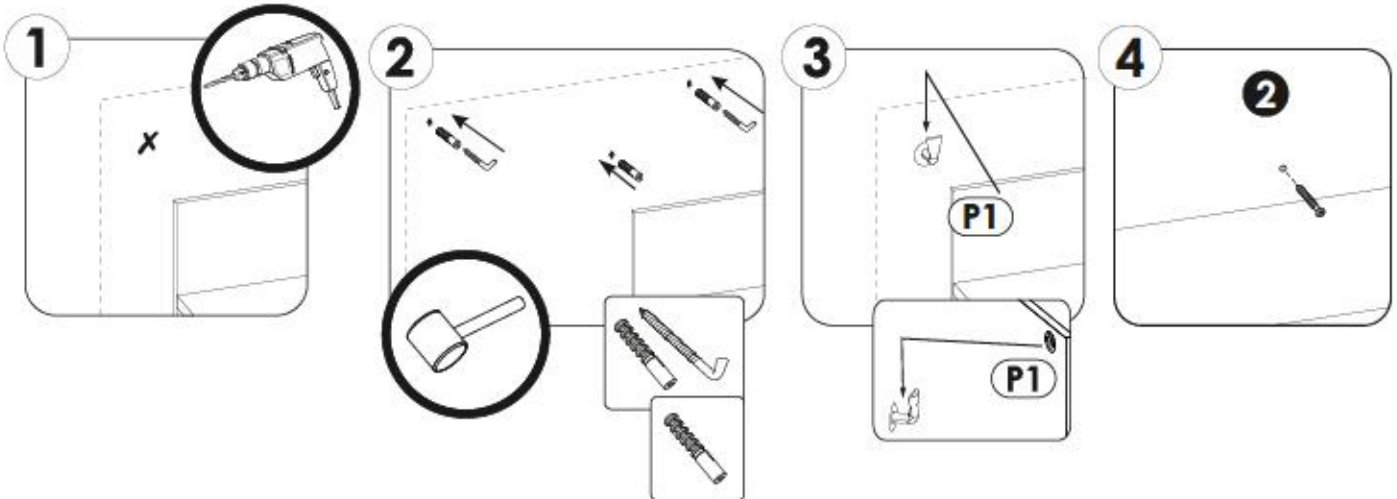
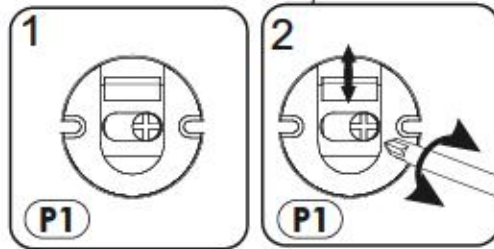
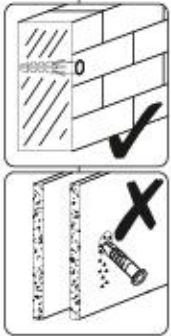
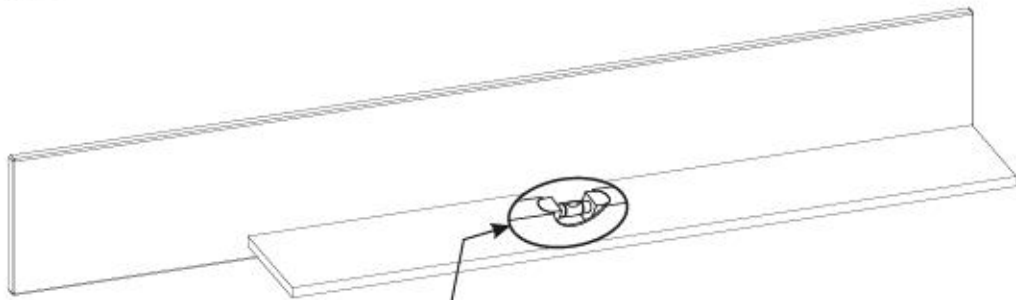
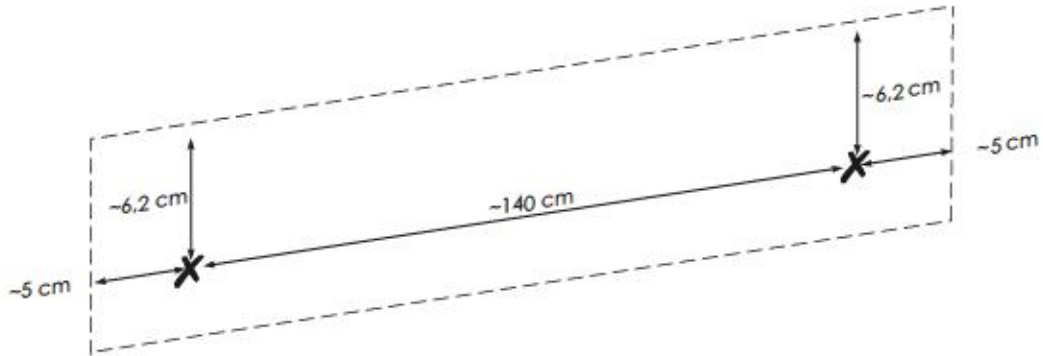

6 ▶

