

980728

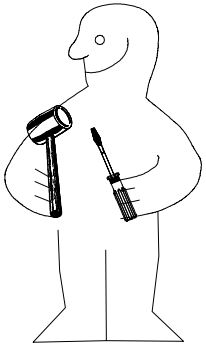

1.

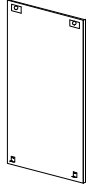

2.

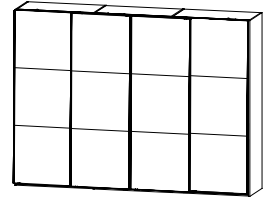
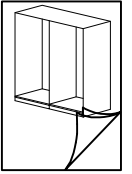
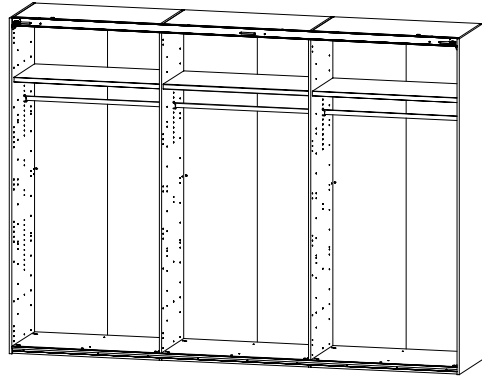
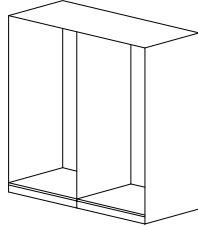

HSP 300 4trg NG

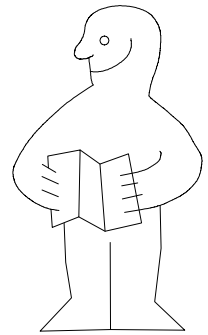
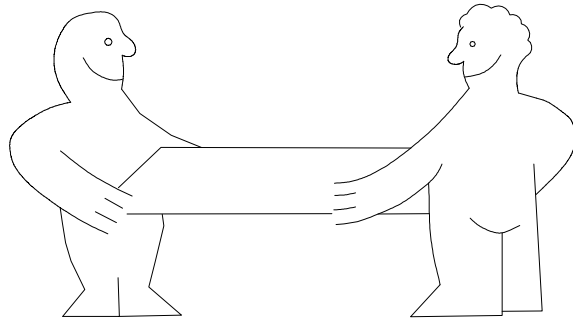
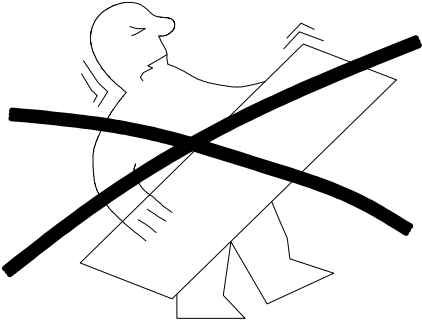

1-2-3-4... ○

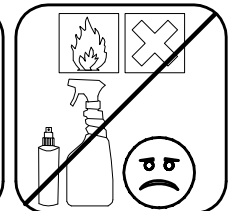
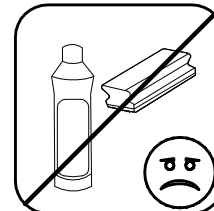
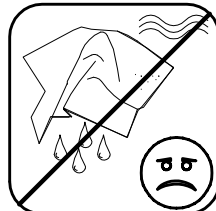
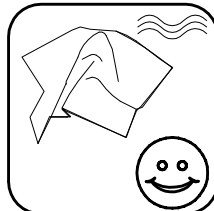
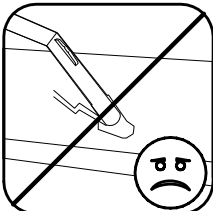
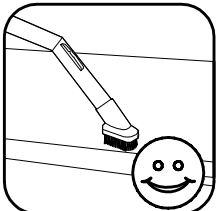
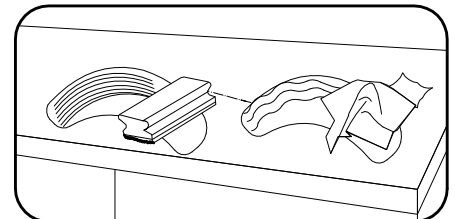
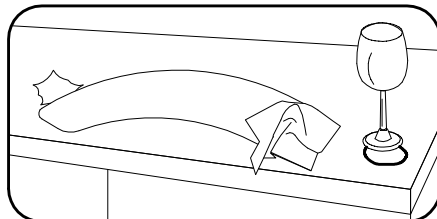
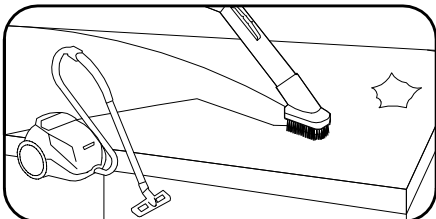
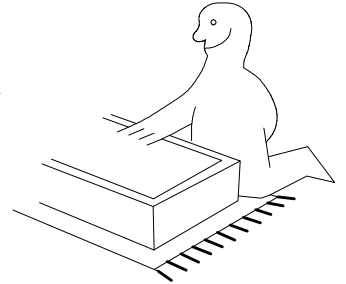
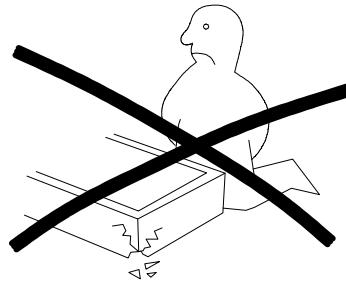
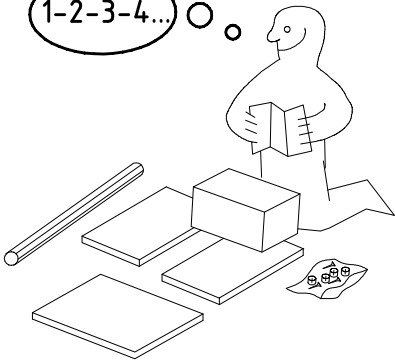





980728

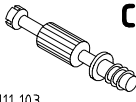

20.12.16 / -



12 16

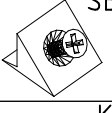

1/11

 111 xxx	A1 24x
 111 103	C 8x
	F3 8x

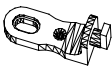
 111 xxx	S0 15x
 111 xxx ø12	V12 15x
 121 370 3,5 x 15 mm	G1 42x

 117 002	K2 6x
	SBV 24x
 100cm 121 400	K10 3x

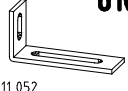

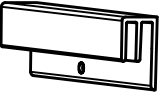

 111 611	J2 9x
 112 055 6,3 x 10,5 mm	T1 36x
 111 607	L8 12x

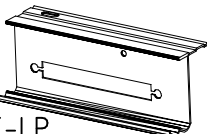

 111 052	o10 1x
 121 120 4 x 15mm	SP15 4x

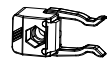
1x 
FPK
1453/1940/2430/2920/3408

1x 
SWT-LP
1453/1940/2430/2920SY
/3410 SY

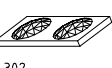

 121 xxx	SWT-ST 2x
 121 xxx M4 x 13 mm	SWT-SM5 2x
 121 xxx M4 x 10 mm	GH13 6x
 121 xxx 3,5 x 35 mm	G43 6x
 121 375	G14 2x

 121 004	SWH-SKL 1x
 121 004 3,5 x 22 mm	SWH-SKR 1x
 121 004	G24 10x
 352 302	KP8 4x

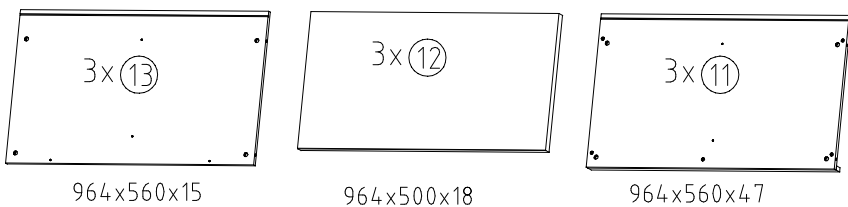
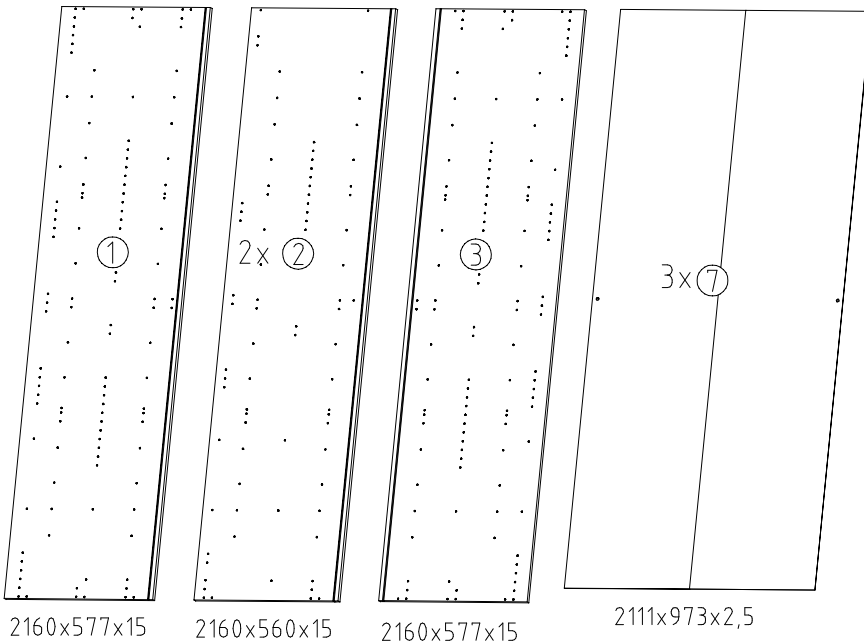
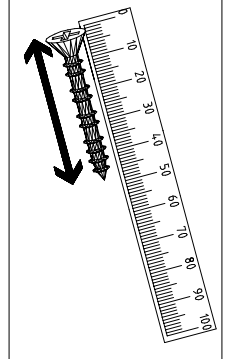
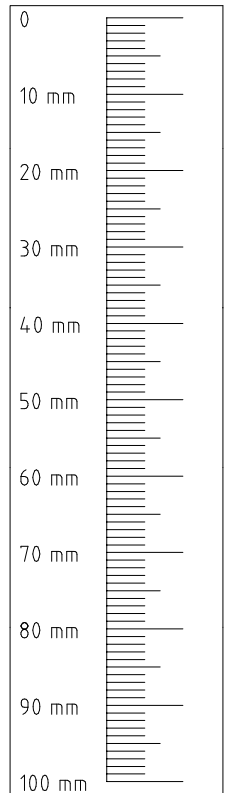
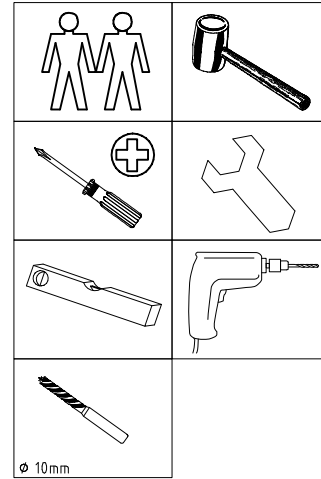

1

3,5 x 15 mm

G1

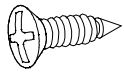

121 370

S0

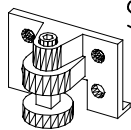

111 xxx

A1



111 xxx

3

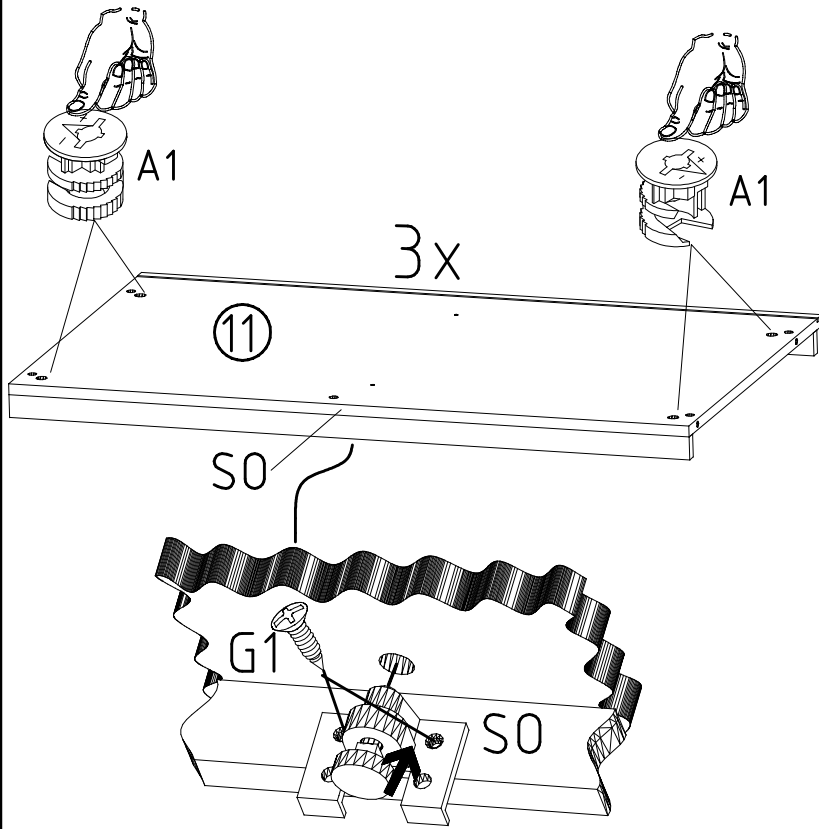

2

A1

111 xxx

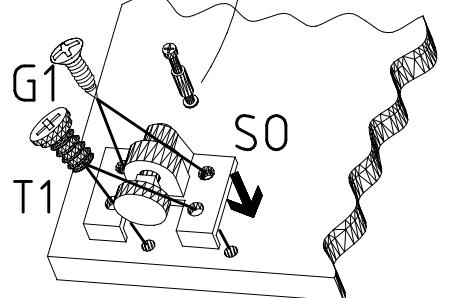
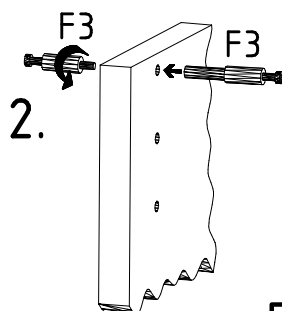
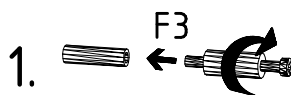
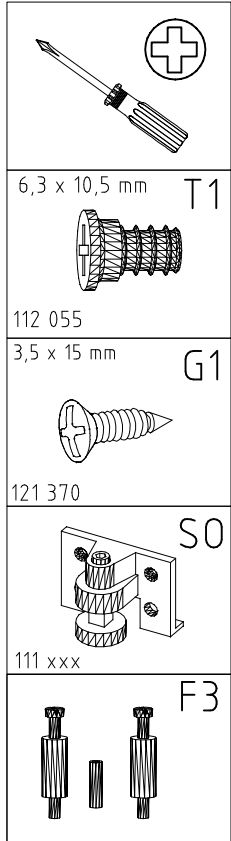
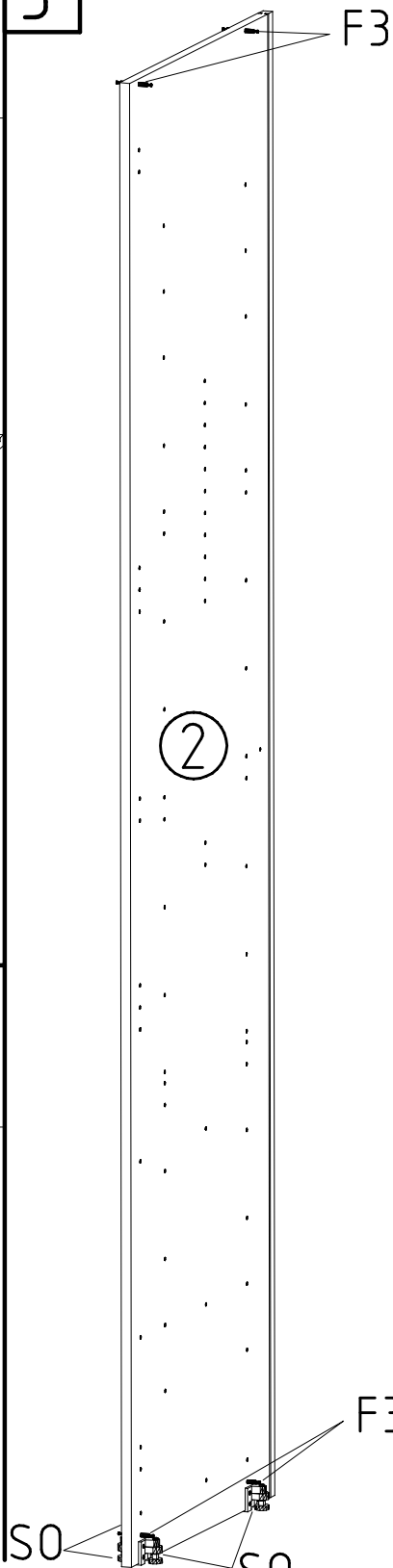
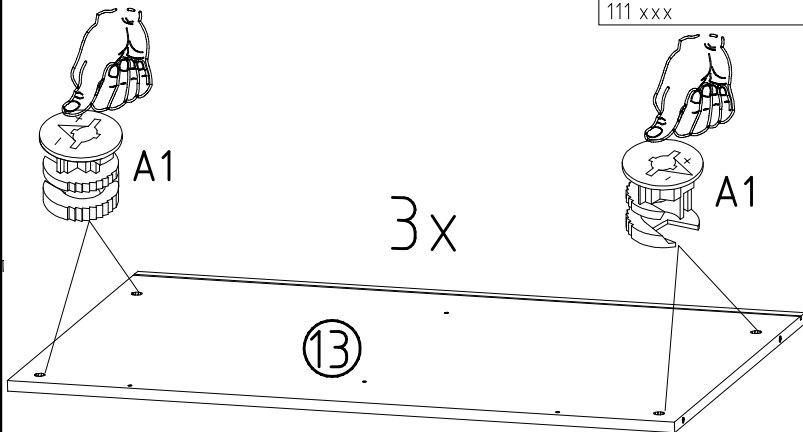

4

SWH-SKL

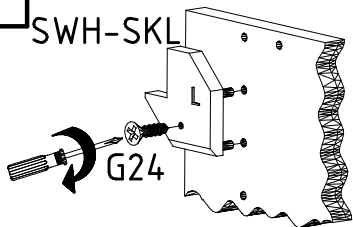

SWH-SKR

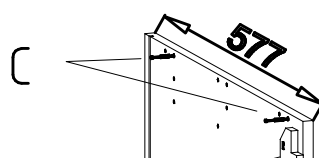
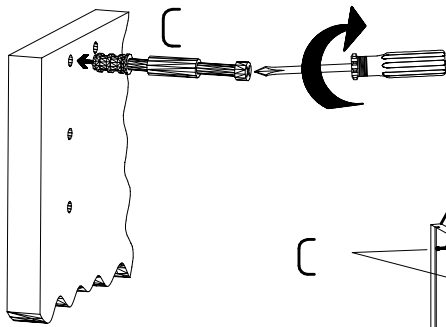
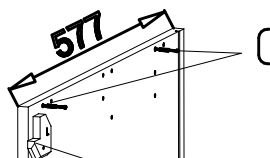
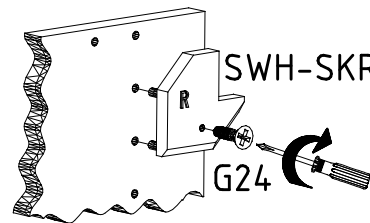

SWH-SKL + G24

SWH-SKR + G24

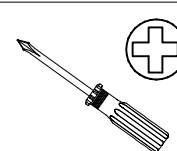

SWH-SKL

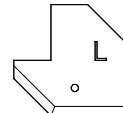

SWH-SKR

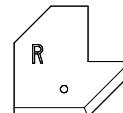

3,5 x 22 mm G24

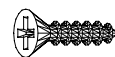

121 004

6,3 x 10,5 mm T1

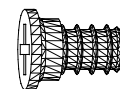

112 055

3,5 x 15 mm G1

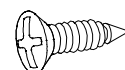

121 370

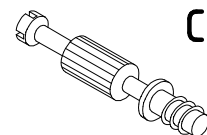

111 103

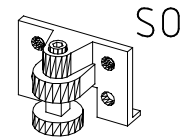

111 xxx

1

3

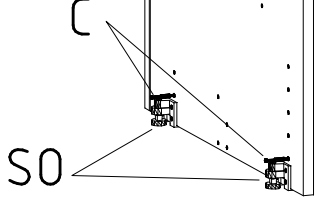
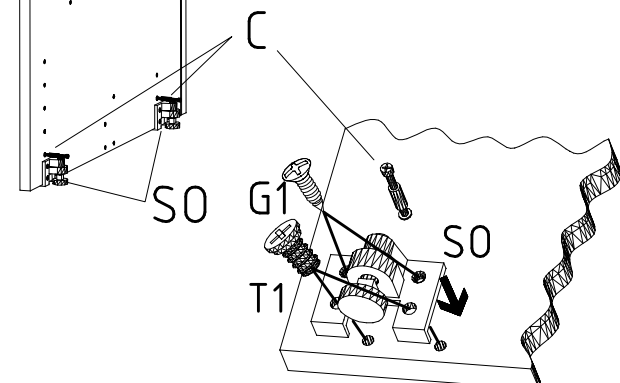

5

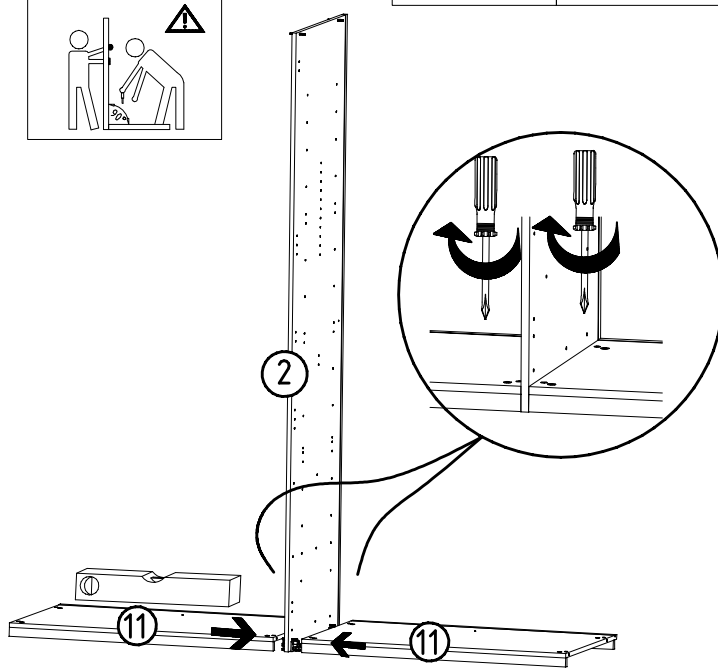
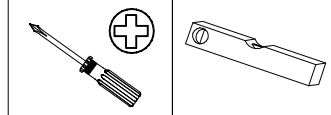

6

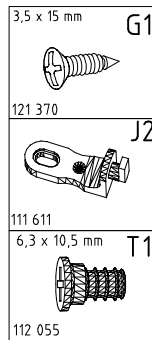
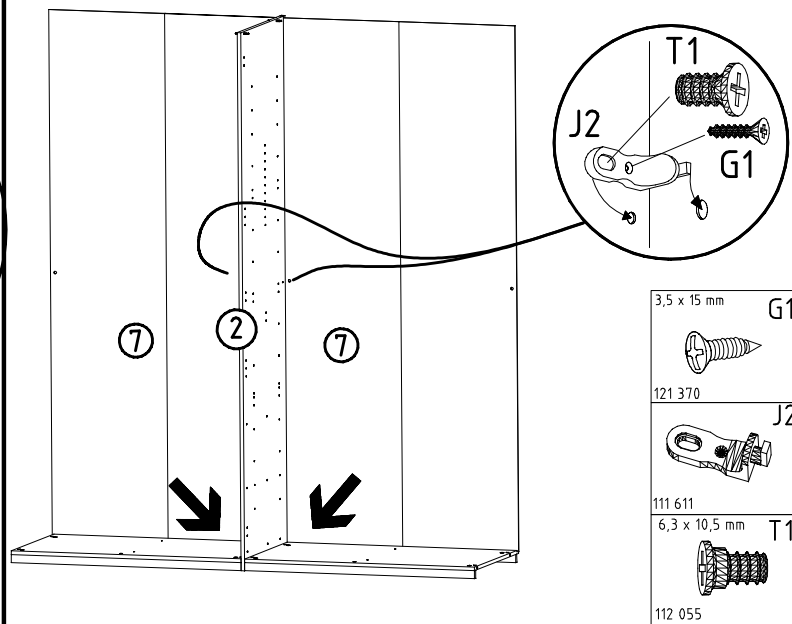
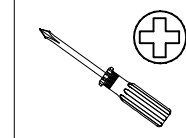

7

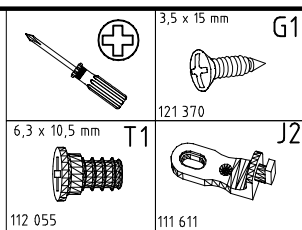

8

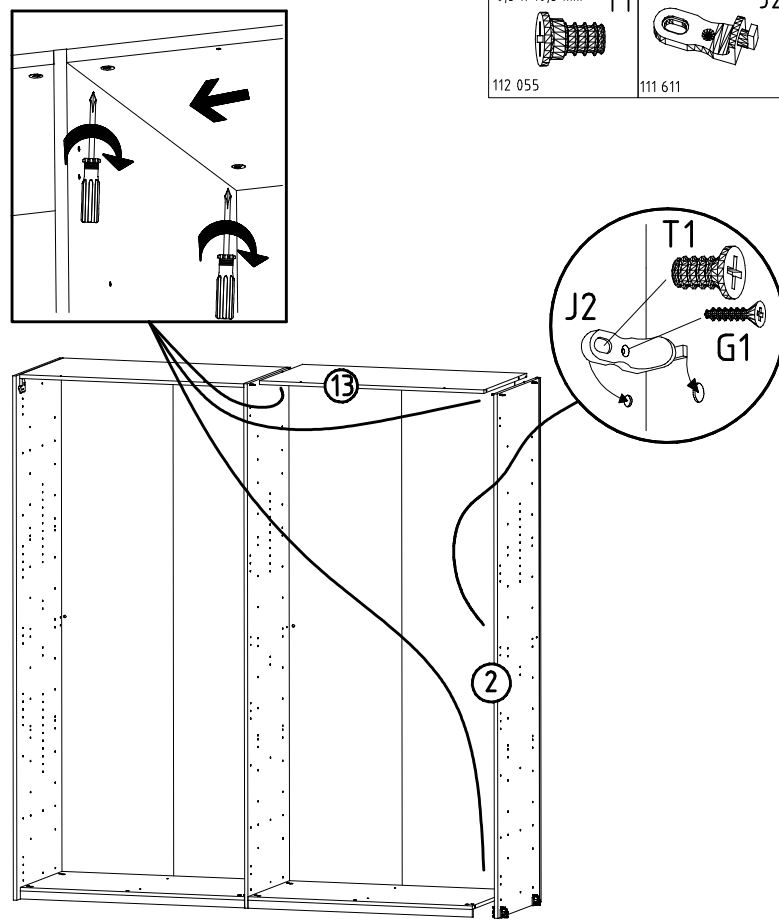
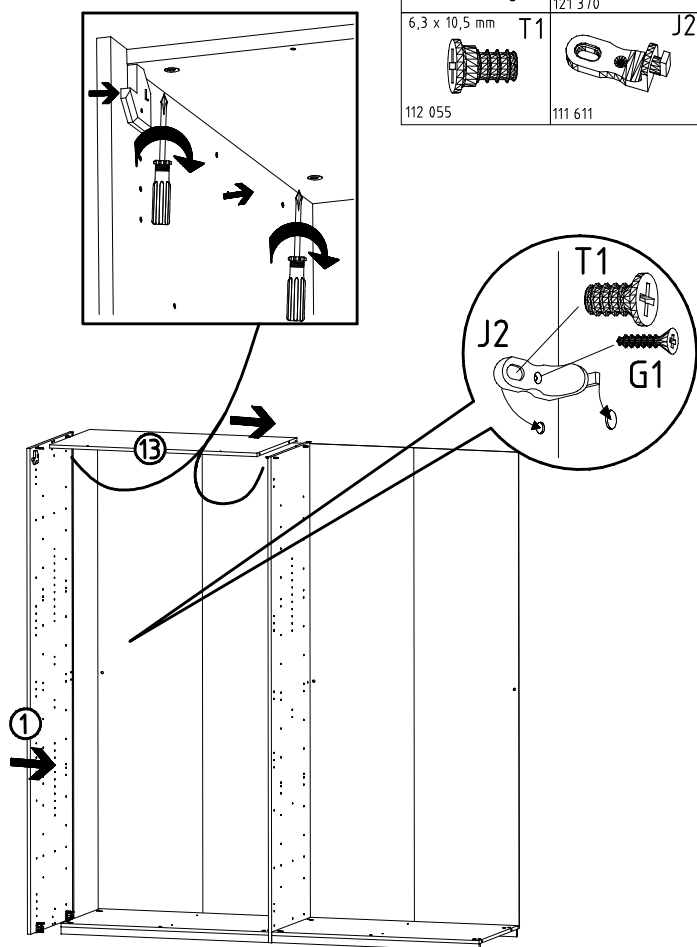
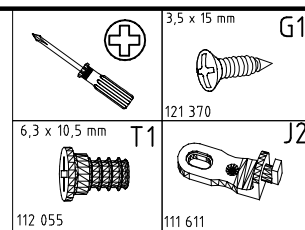

9

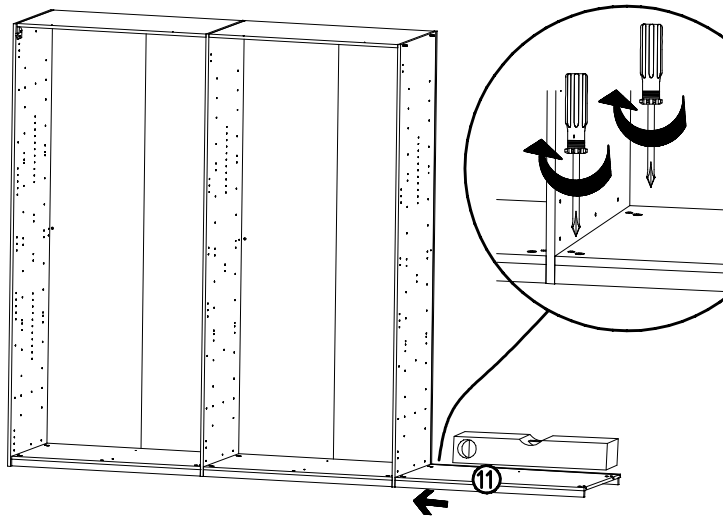
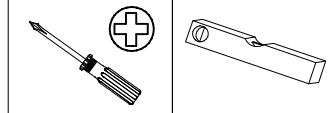
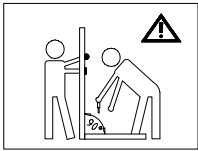

10

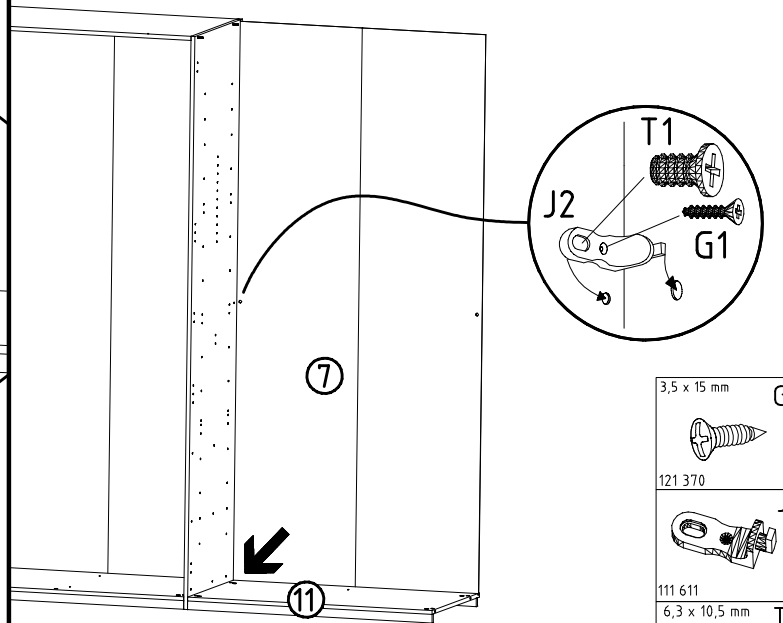
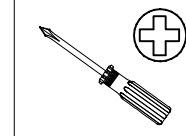

- 3,5 x 15 mm G1
- 121 370
- 111 611
- 6,3 x 10,5 mm T1
- 112 055

11

- 3,5 x 15 mm G1
- 121 370
- 111 611
- 6,3 x 10,5 mm T1
- 112 055

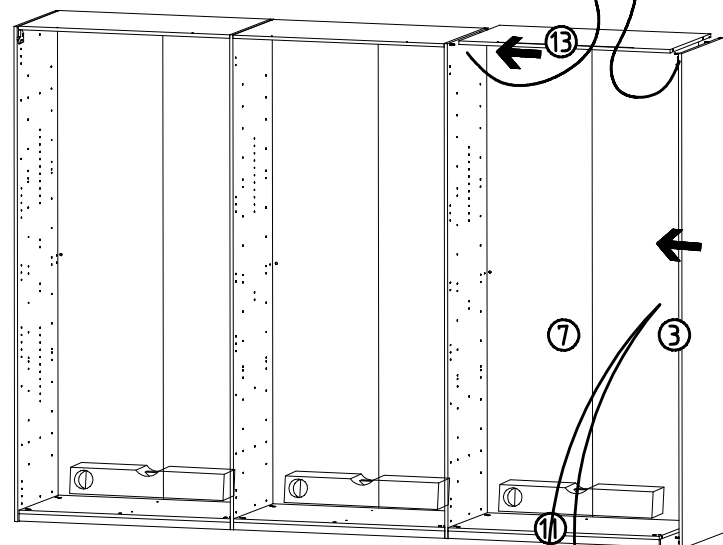
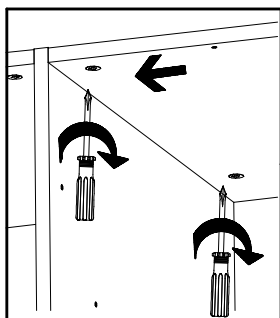

12

- L8
- 111 607
- K2
- 117 002
- 3,5 x 15 mm G1
- 121 370
- 100cm
- 112 400

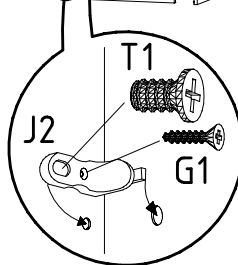
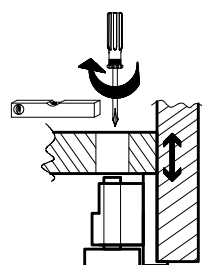
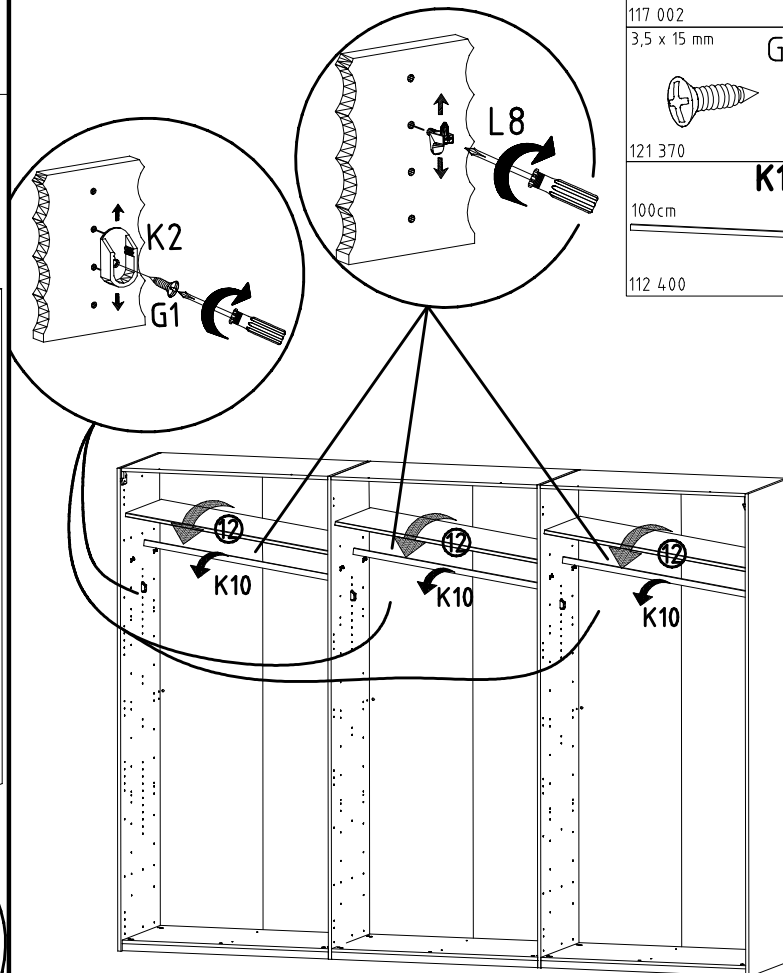

13

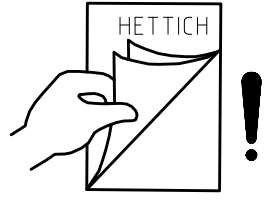
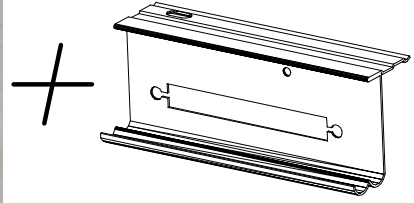
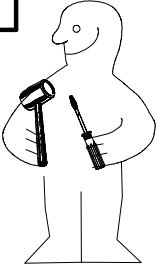

14

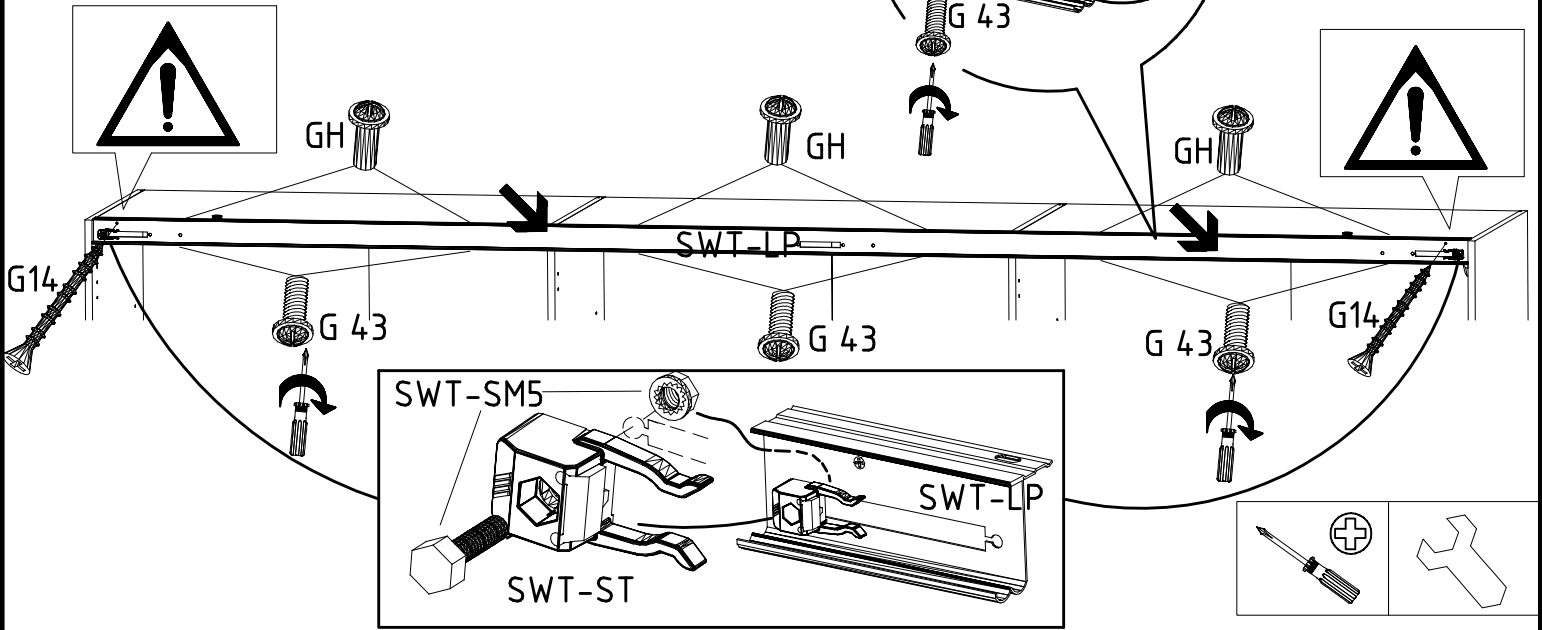
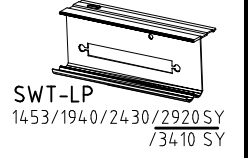
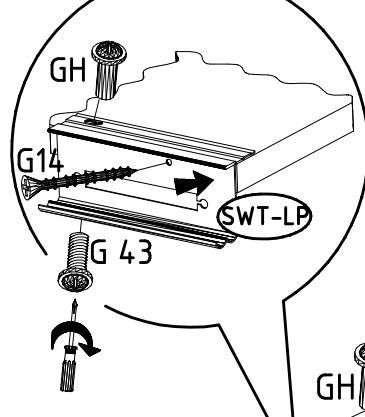
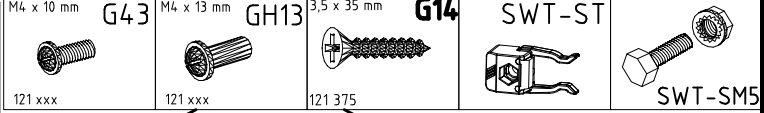
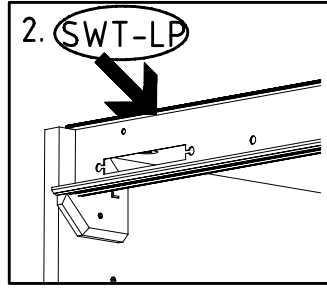
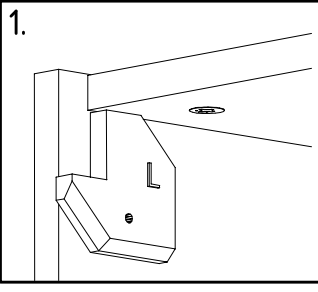

15

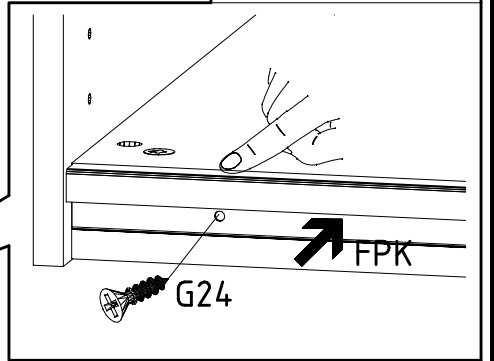
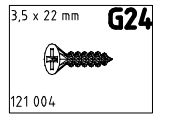
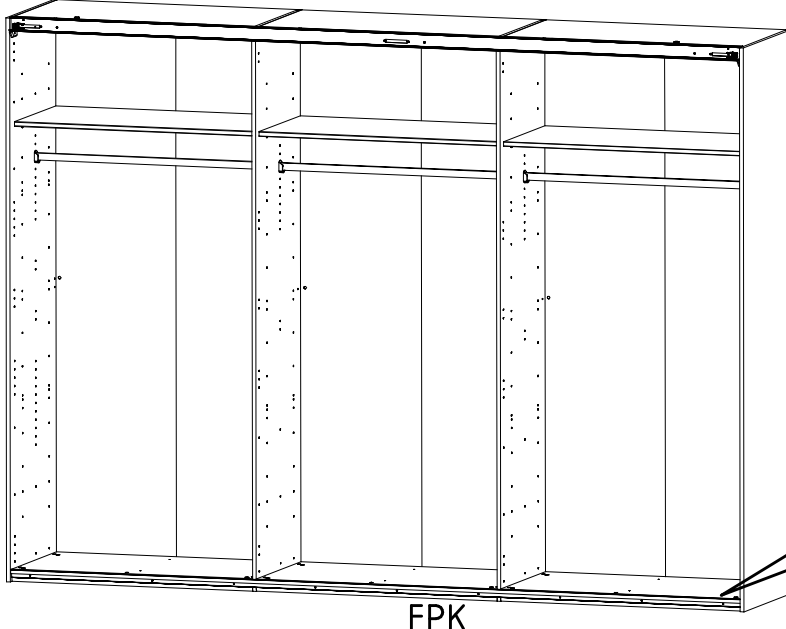

16

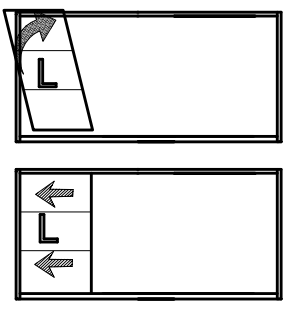

17

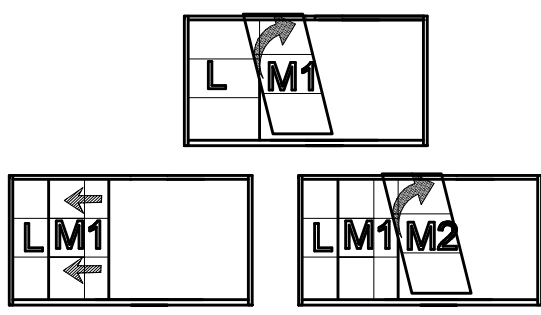

18

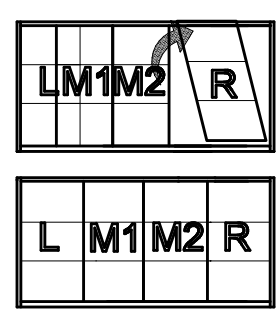

16 + 18

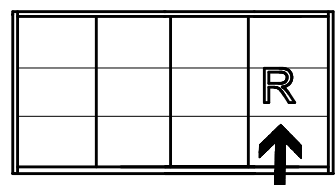
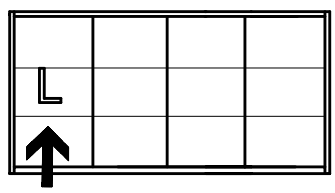

17

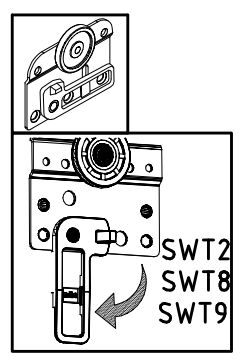
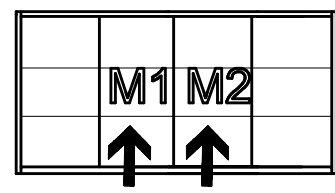

I.

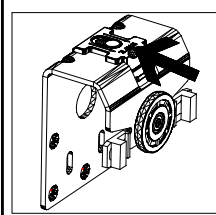
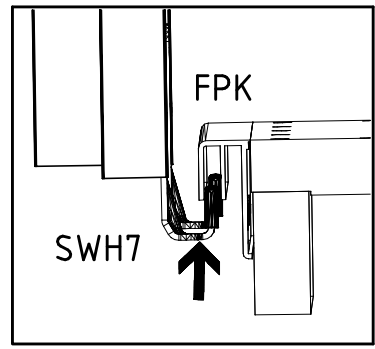

I.

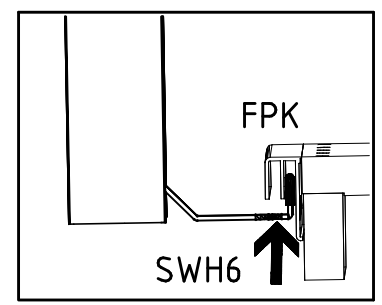

II.

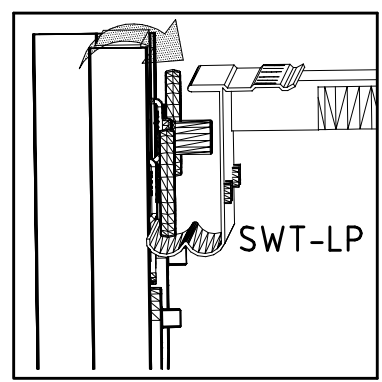

II.

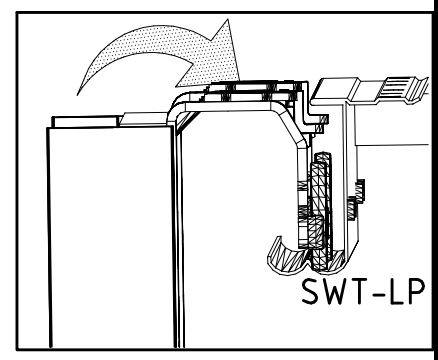

III.

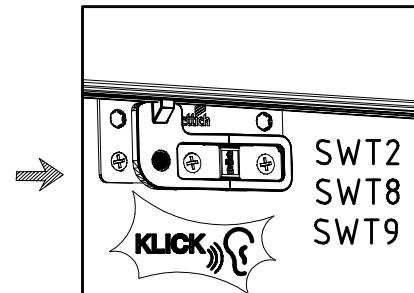
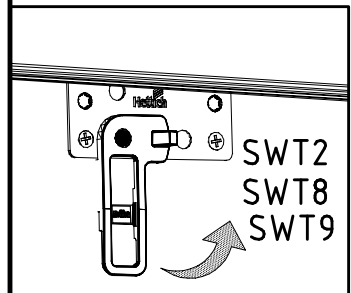

III.

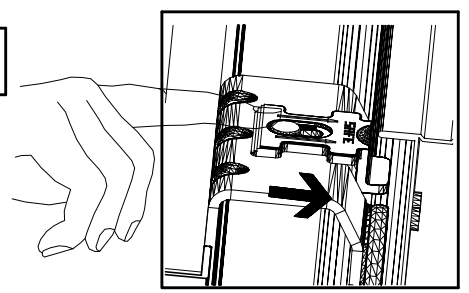

19

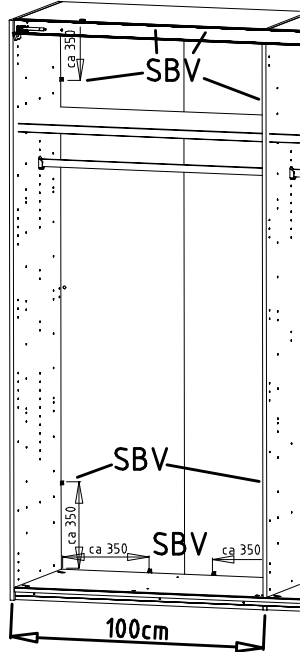
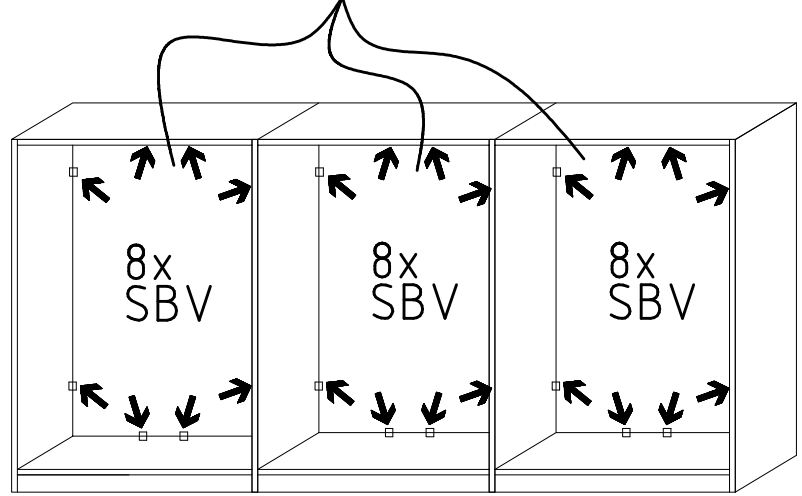
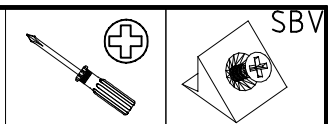
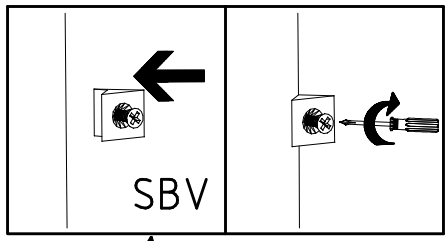

20

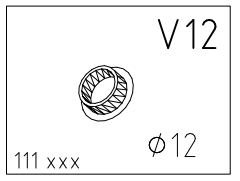
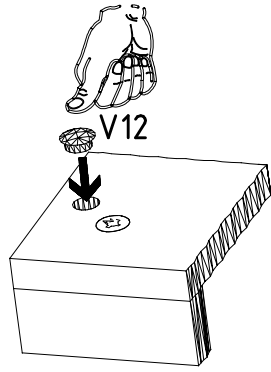
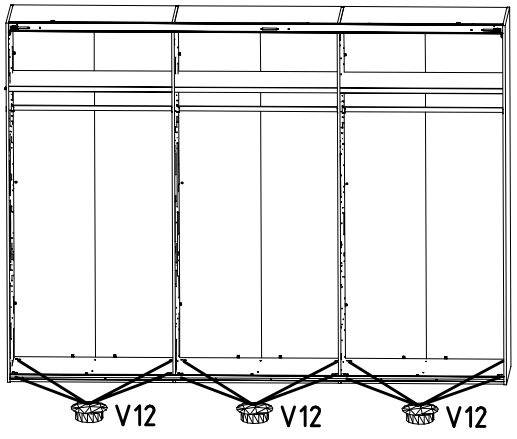

21

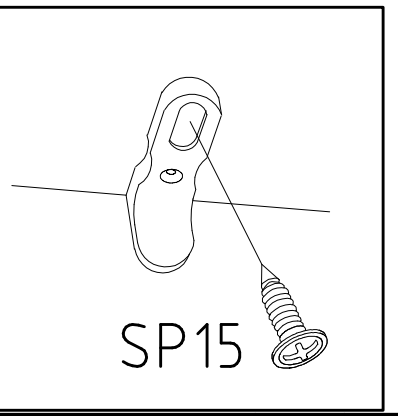
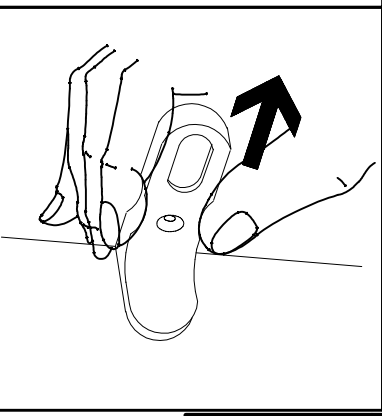
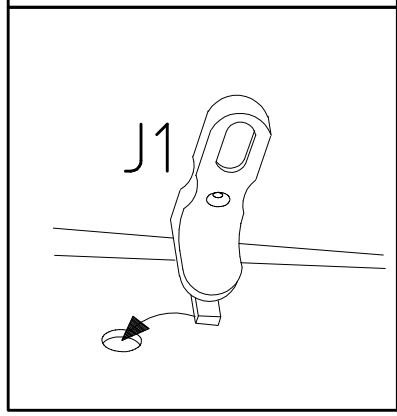
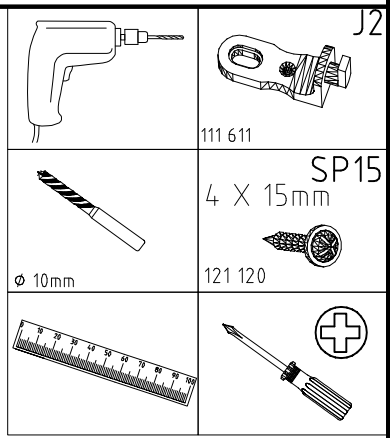
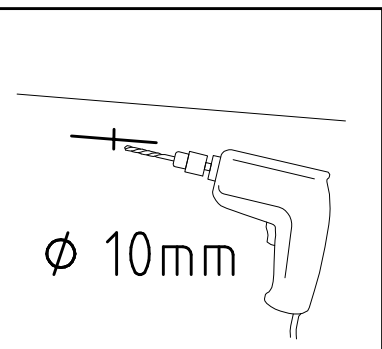
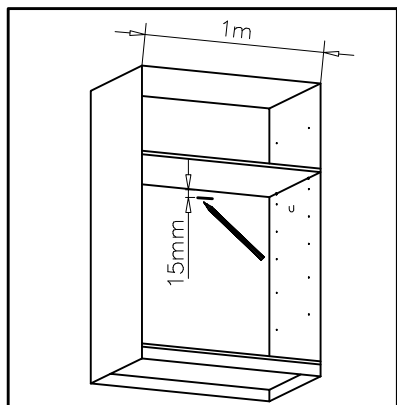

22

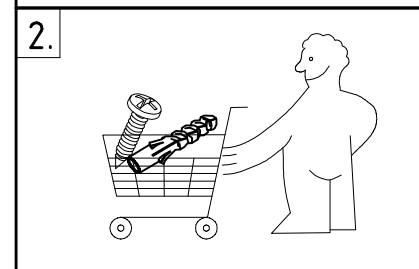
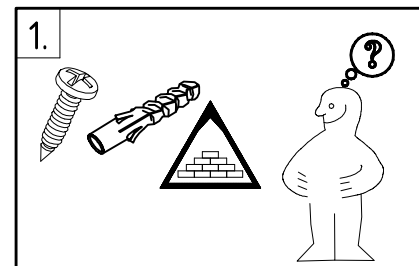
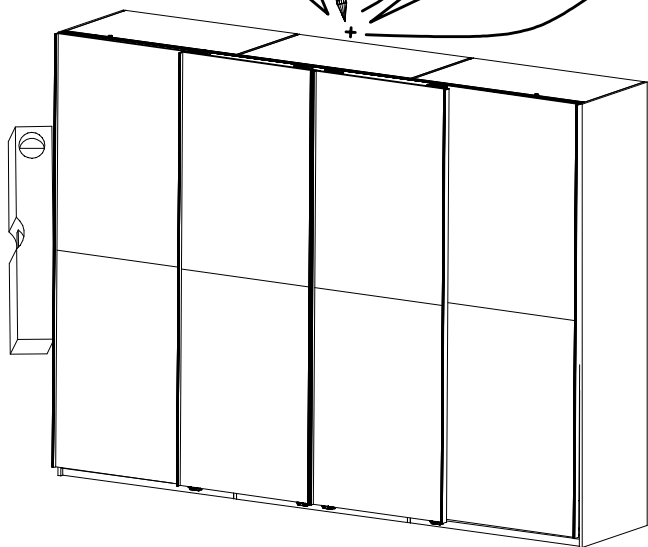
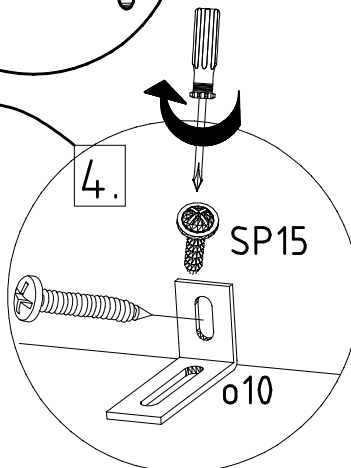
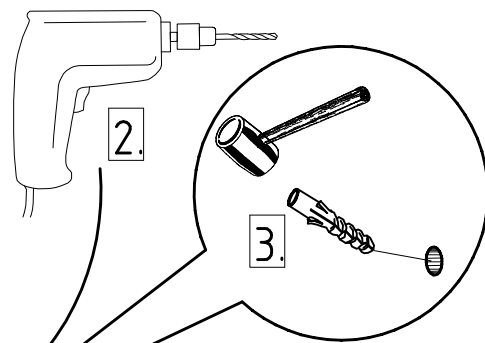
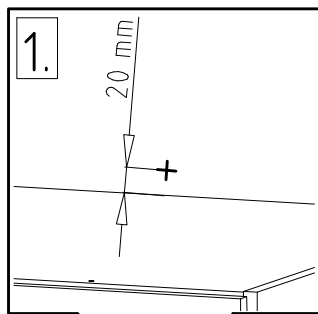
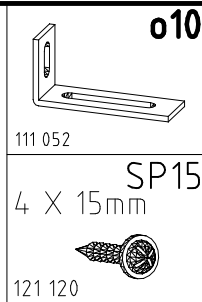
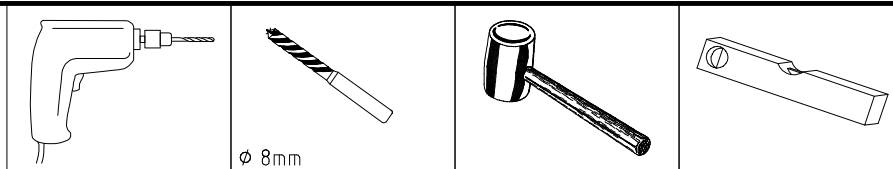

23

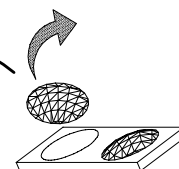
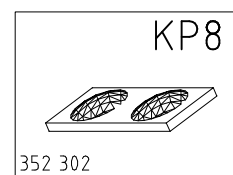
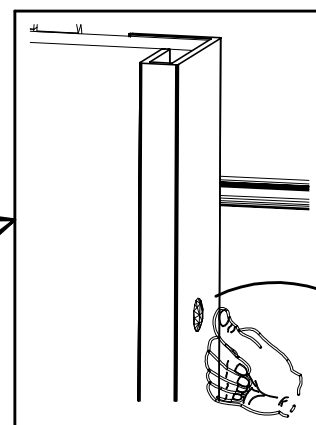
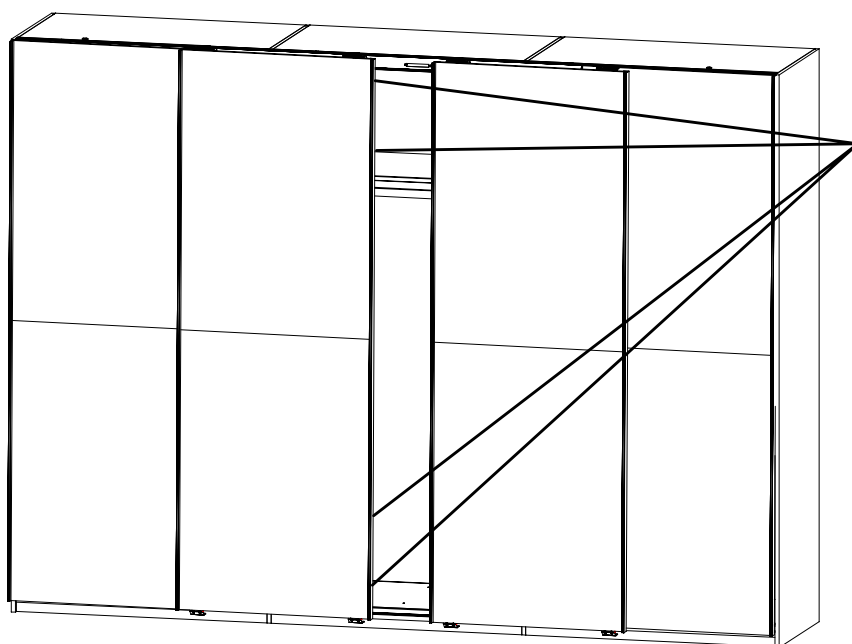

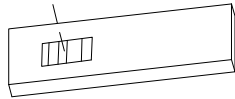
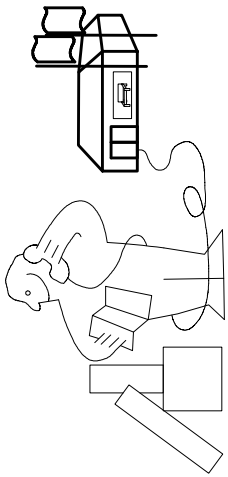
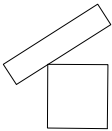
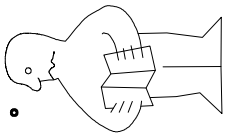

Modell/Model/Modèle

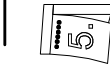

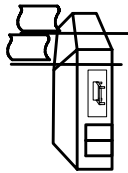

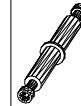
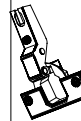
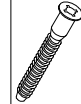

<121 370>

< G 1 >

<4x>

Änderungen die dem technischen Fortschritt geschuldet sind, behalten wir uns vor !

Bei nicht vorschriftsmäßiger und/ oder nicht fachmännischer Montage wird bei Personen- und/ oder Sachschäden keinerlei Haftung übernommen.

WIMEX Wohnbedarf/ Import Export Handels GmbH/ Postfach 1407/ 49112 Georgsmarienhütte/ Germany
Tel.:(+49) 05401 8598 72 Fax.:(+49) 05401 8598 33 Mail: service_H@wimex-online.com

104P-NR. / 104P-NO. 150X-NR. / 150X-NO. Auftrag/Order-No. / No. de Commande

23203 **30110XY** 104

Kunde MAX MUSTERMANN
Customer
Client

Kommission / your order reference / votre reference

3377 MINDEN

Dekor / Decor Decor / Modell / Modele

F99 **SAMPLE**

F99842 SCHWEBETUERENSCHRANK 250 CM H 216CM
PLANKENEICHE NB + RAH STEEL
PLANKENEICHE NACHBILDUNG

202320301107241476000001

Paket / Package / Paquet

414760

SOCKEL

Paket 1 von 8 Colli Kommission 10

HSP-SHT BOD 50 TEXT/TEX SOCKEL 32 FRESH TV / LF 104
SO-BOD TEXT RASTEX/ ZNBOD D18MM TX KLSTA

Montage - Anleitung Laenge 520,0 OBEREN
KS-64 Breite 568,0 OBEREN

SOCKEL32 KLEB

Bei Warenauslieferung für Rückgabe beachten!
En cas de livraison de marchandises veuillez retourner le bordereau d'envoi.



OBEREN 5 30/19 HAUT 23.08.19 OBEREN 1 1. JABOVE OBEREN



WIMEX Wohnbedarf
Import Export Handelsges mbH & Co. KG
Werner-von-Siemens-Str. 35
D-49124 Georgsmarienhütte - Germany

SAMPLE **23.08.19**
Modellname Produktionsdatum
Model Date of manufacture

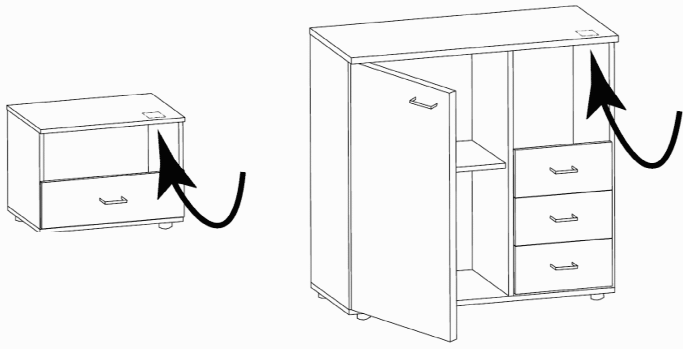
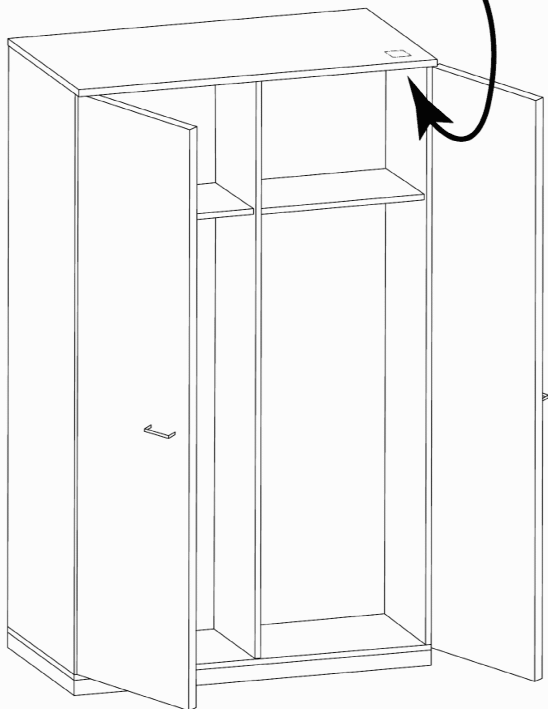
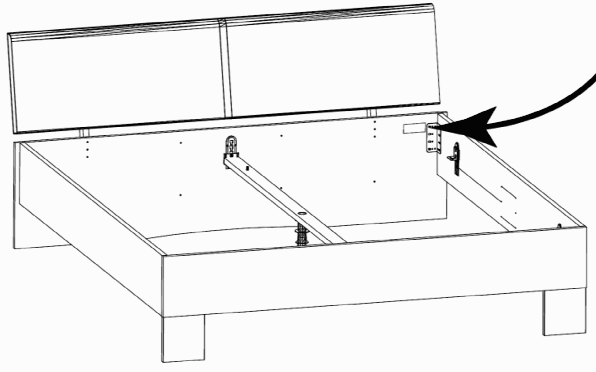

980828



1.

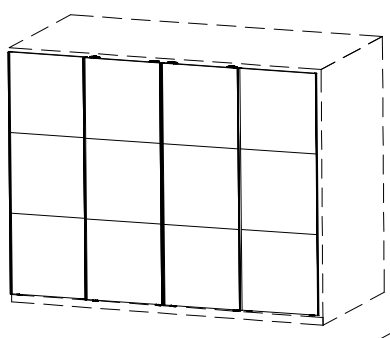
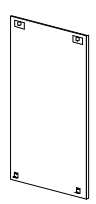

2.

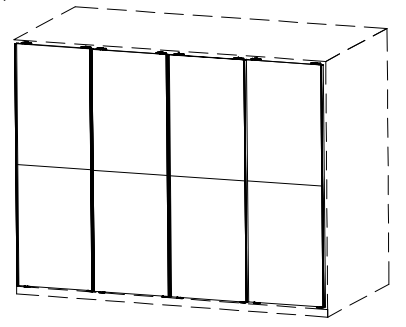
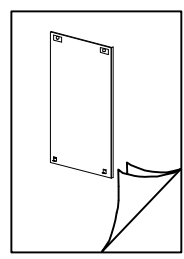
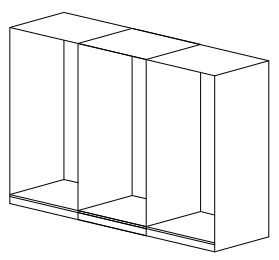
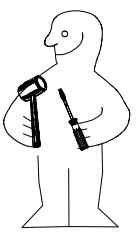

300 HSP Syncro

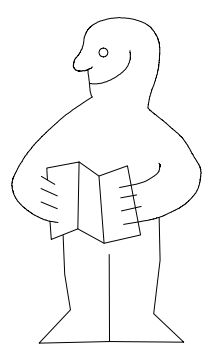
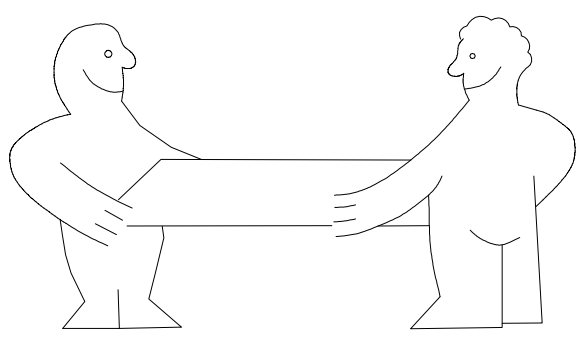
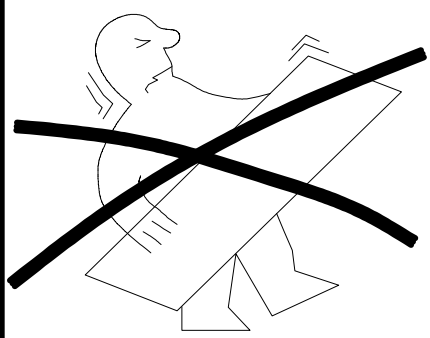

1-2-3-4... ○

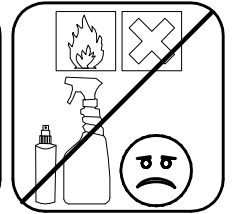
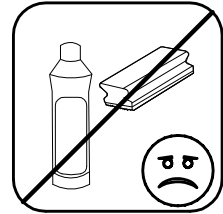
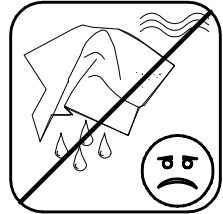
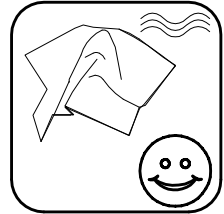
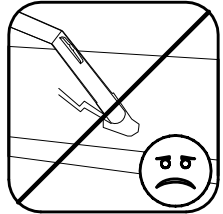
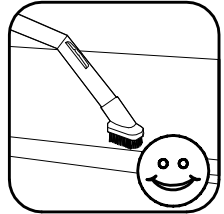
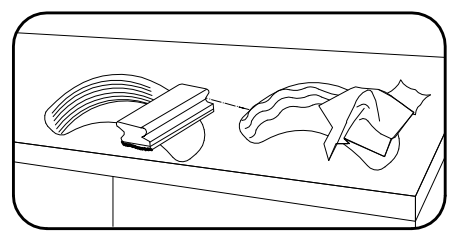
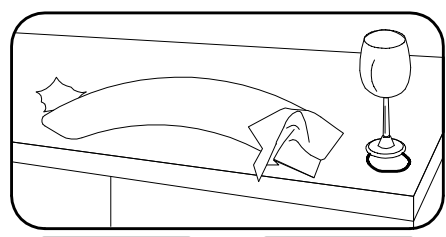
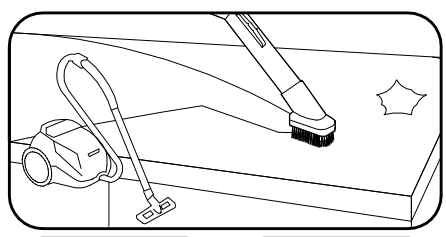
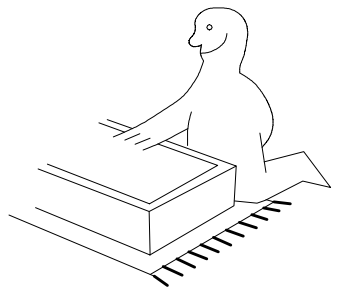
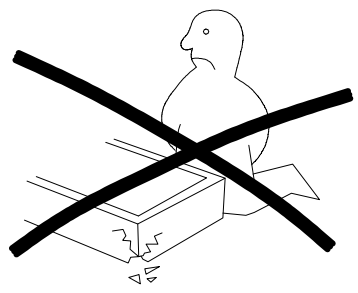
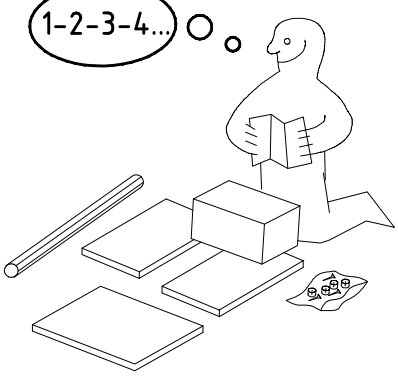

980828

03.12.16 / -

12 16

1/8

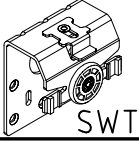
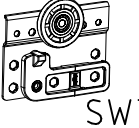
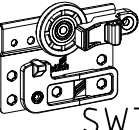
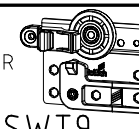
 SWT 1	4x
 SWT 2	2x
 L SWT 8	1x
 R SWT 9	1x

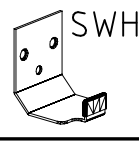
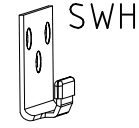
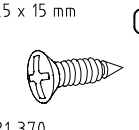
 SWH 6	4x
 SWH 7	4x
 3,5 x 15 mm G1 121 370	2x

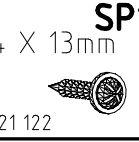
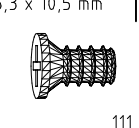
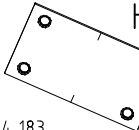
 4 X 13mm SP13 121 122	120x 136x
 6,3 x 10,5 mm T2 111 030	48x
 H5 114 183	4x 8x

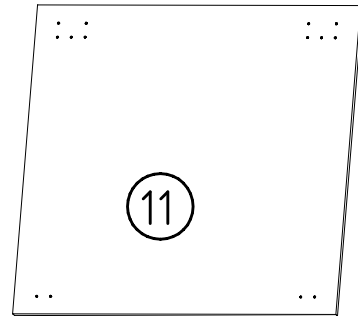
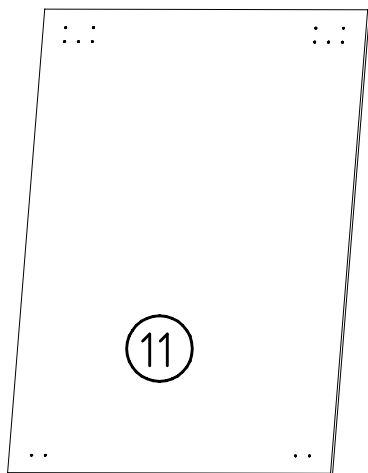
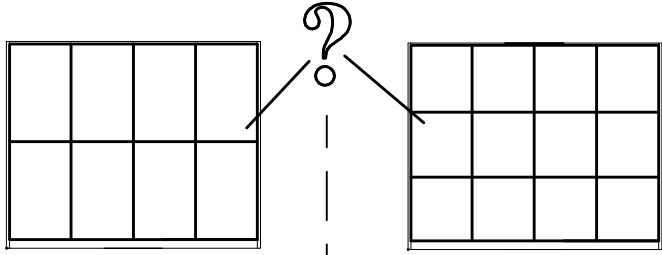
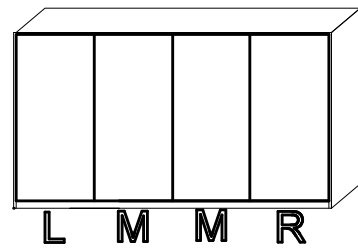
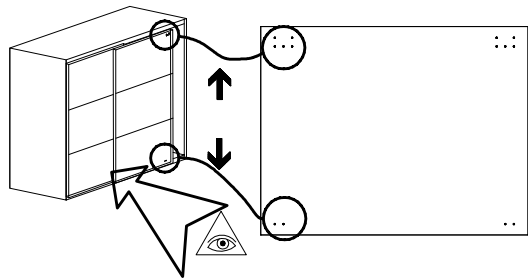
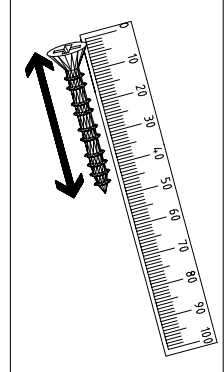
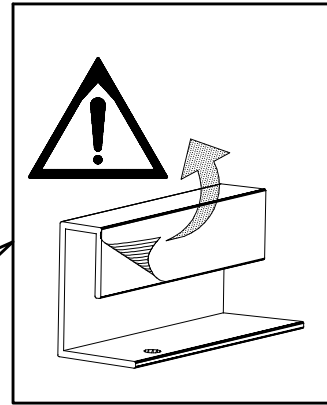
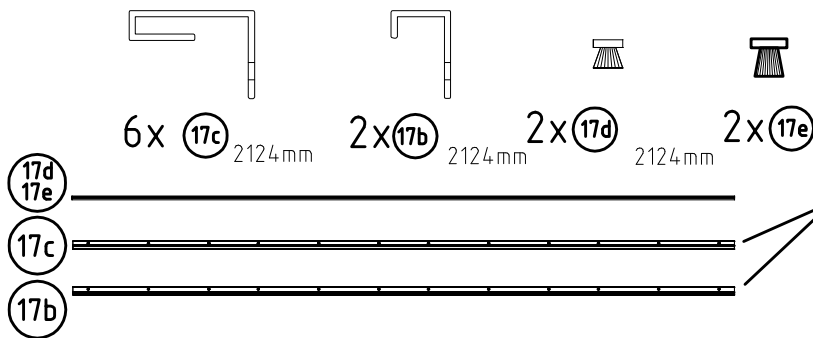
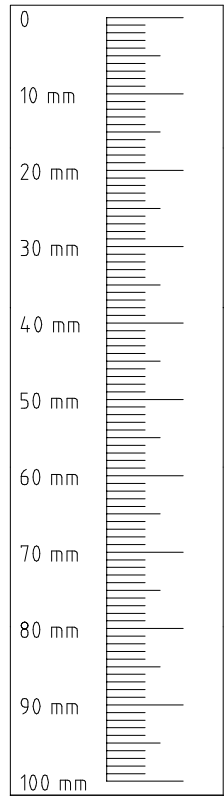
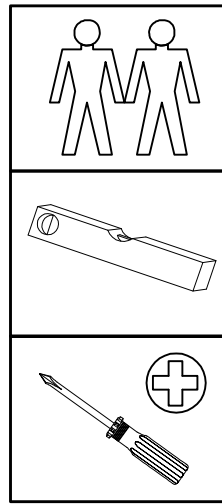

1

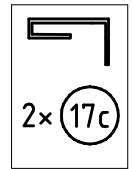
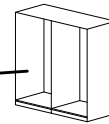
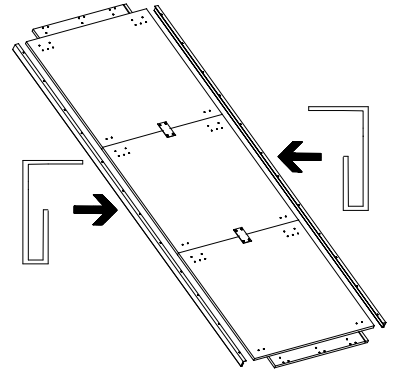
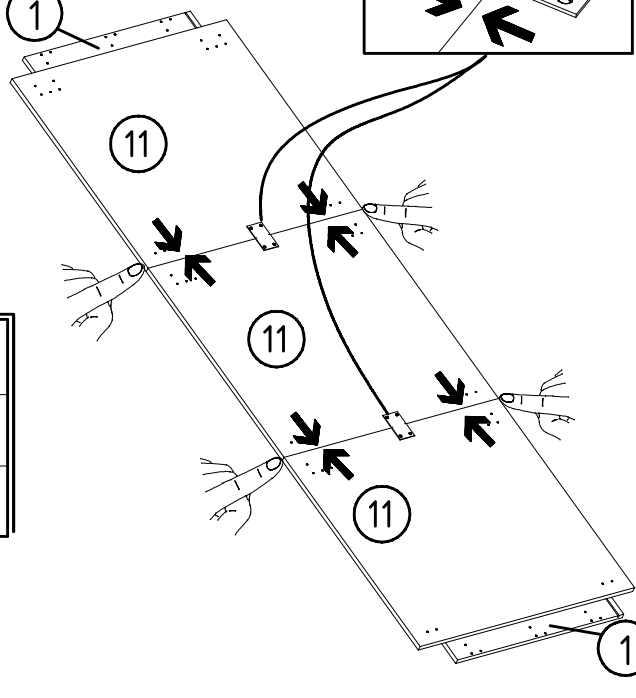
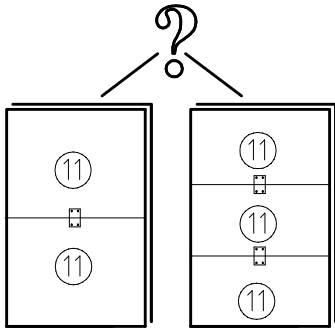
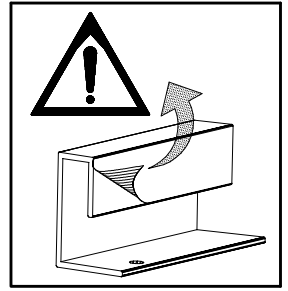
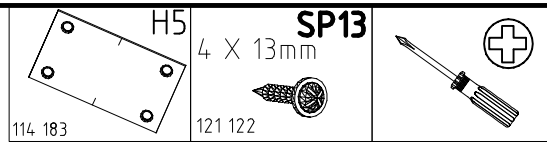
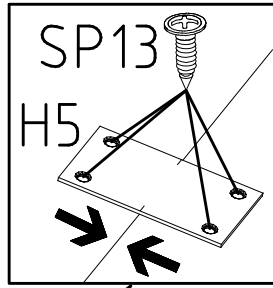
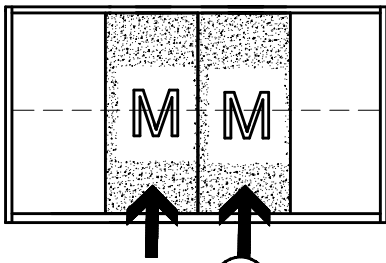

2

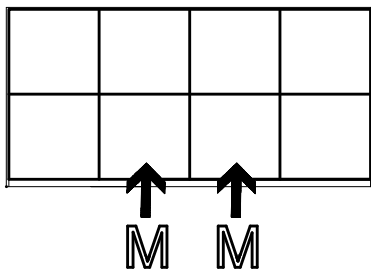
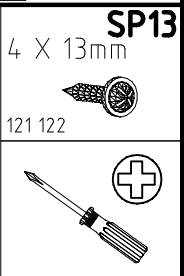
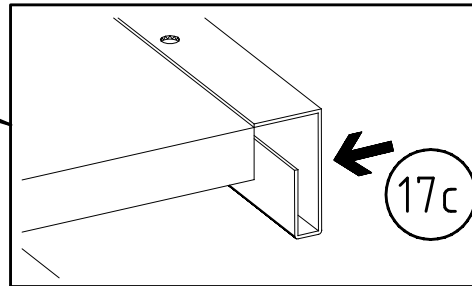
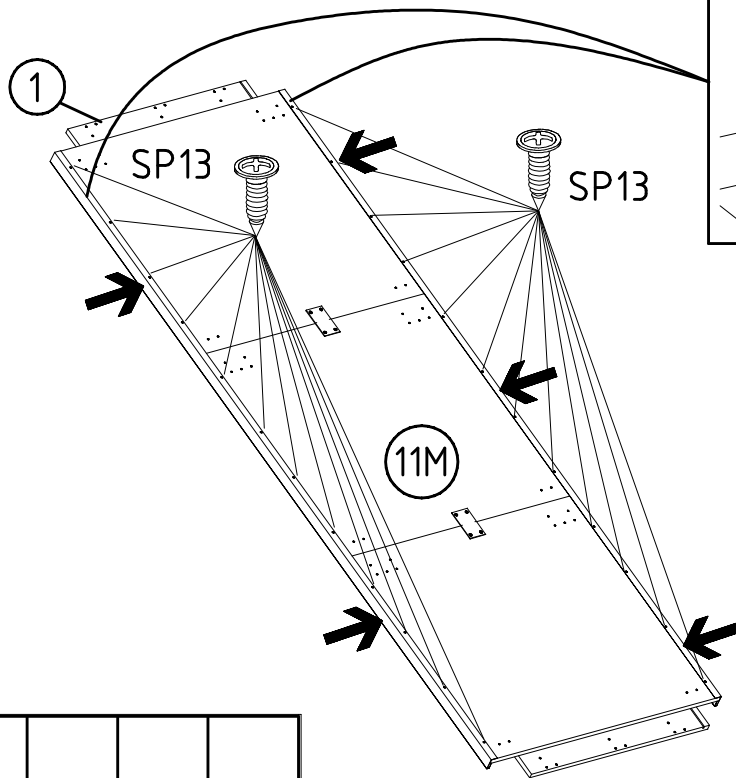

3

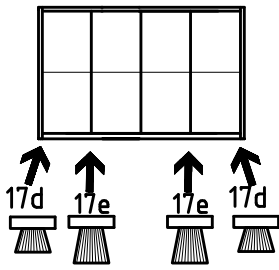
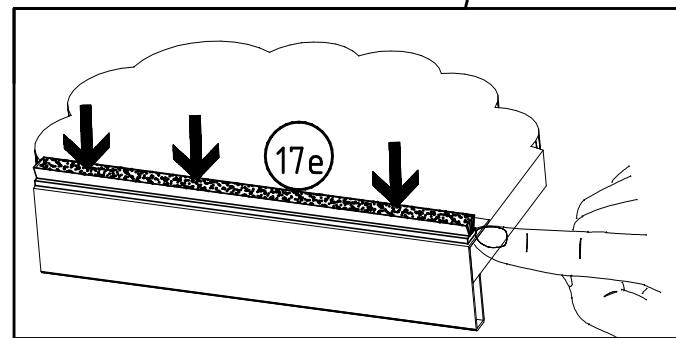
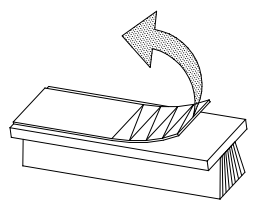
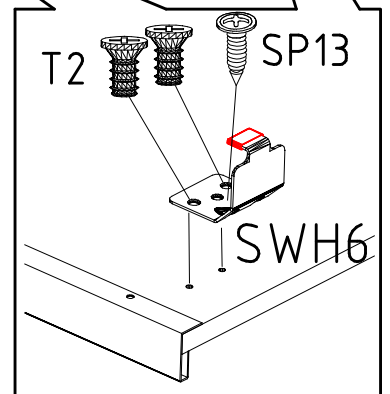
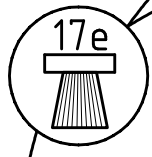
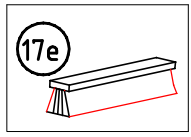
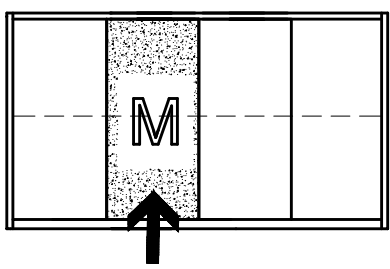
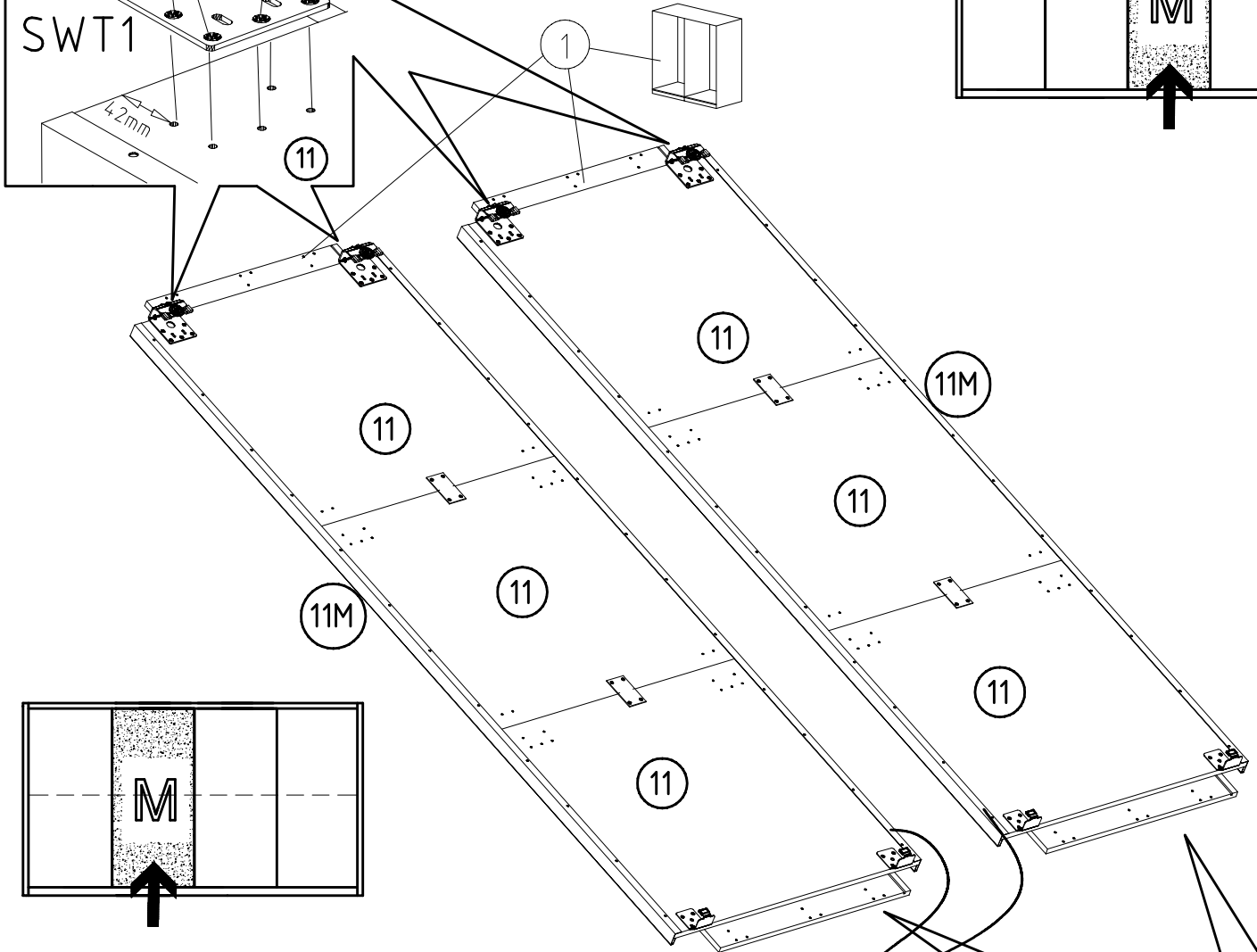
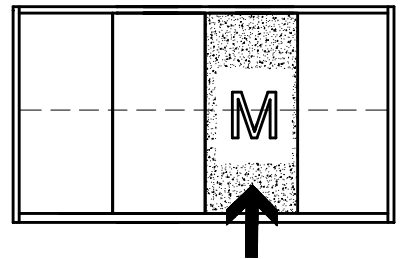
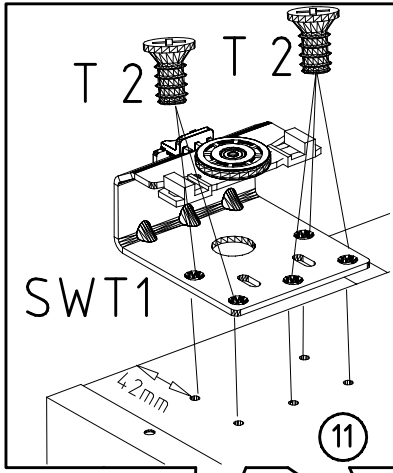
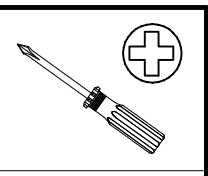
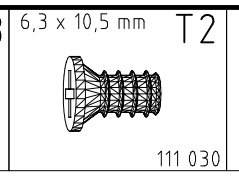
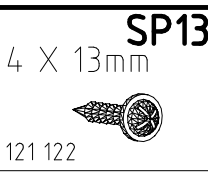
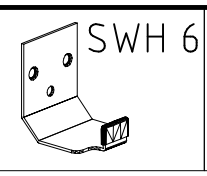
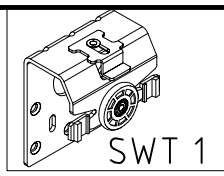

4

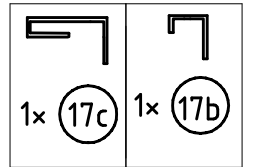
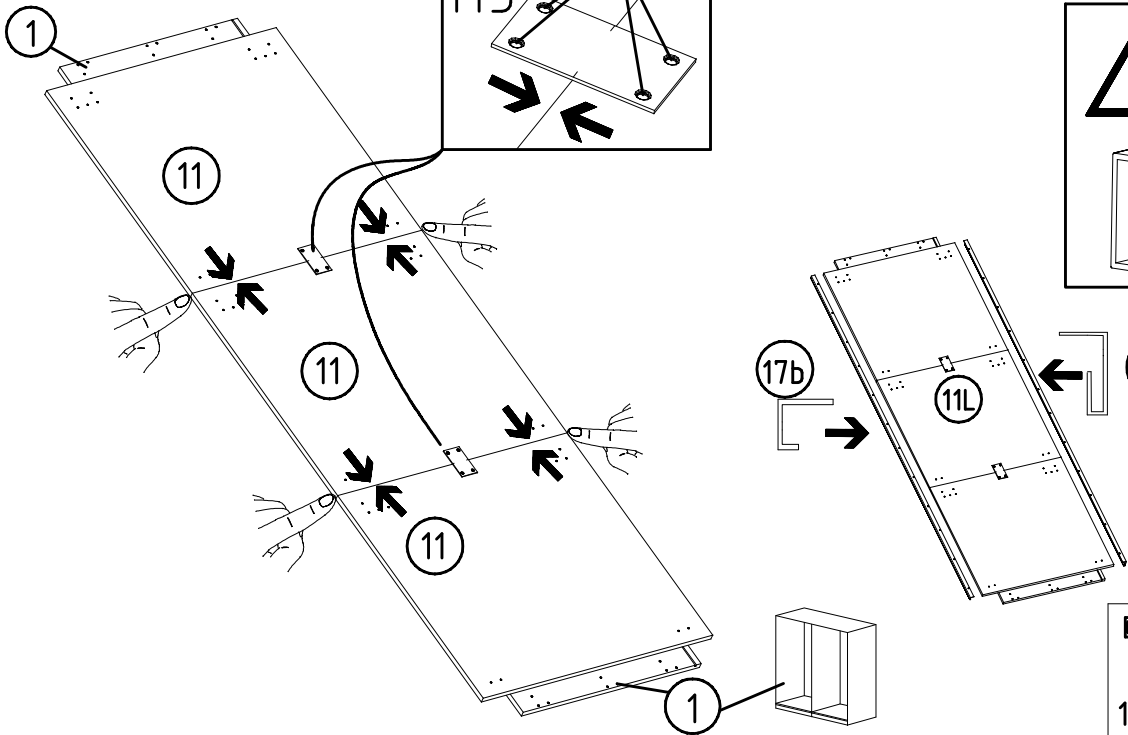
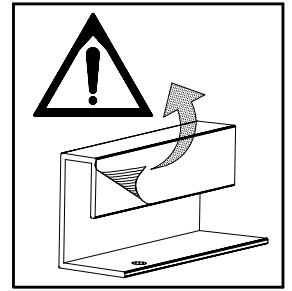
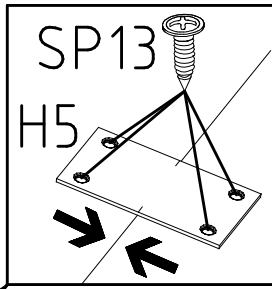
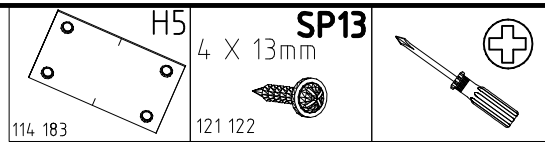
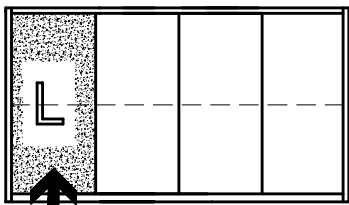

5

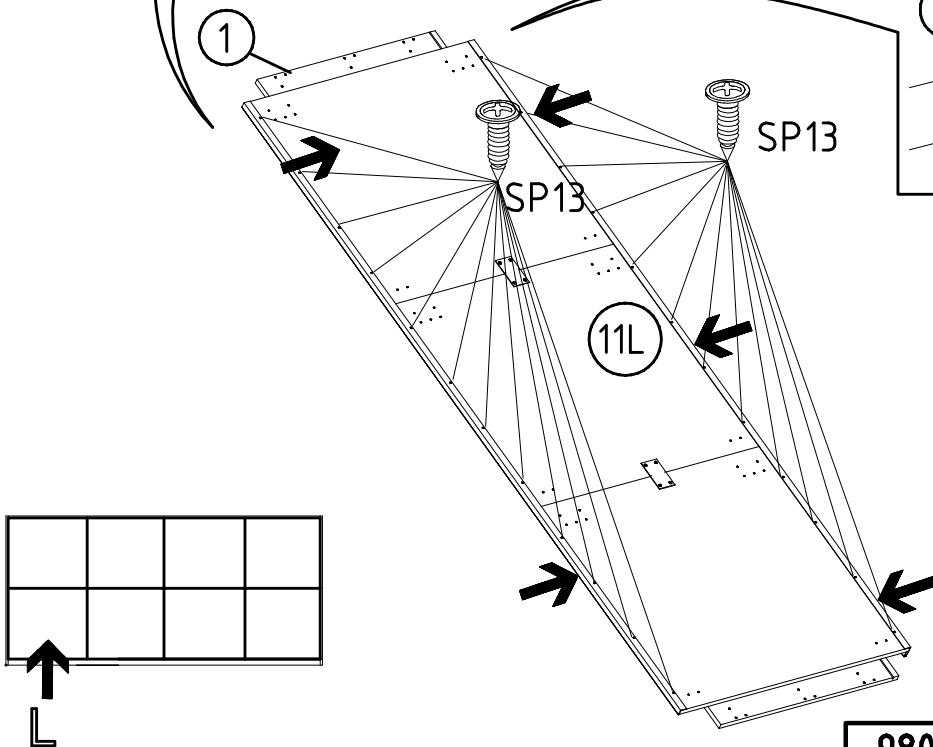
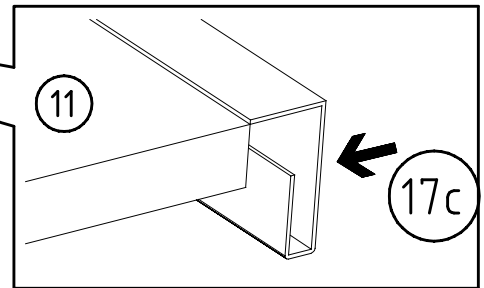
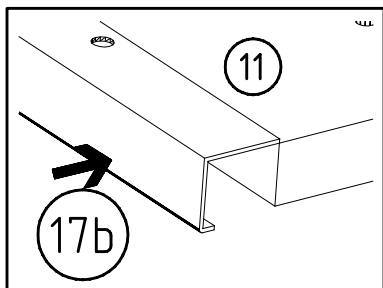
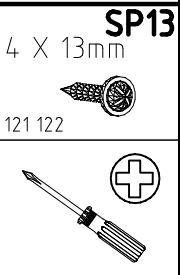

6

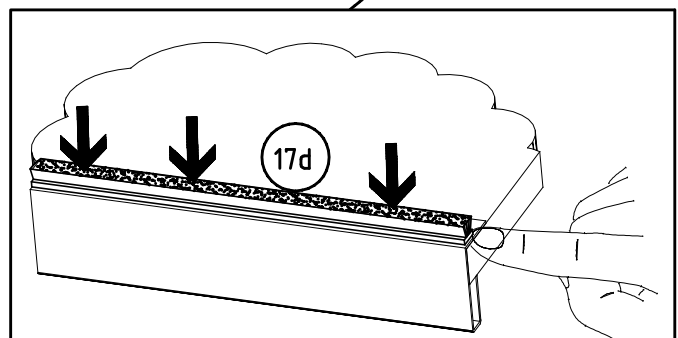
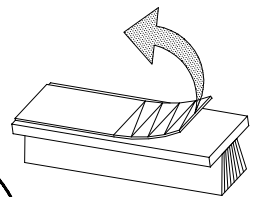
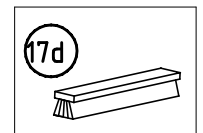
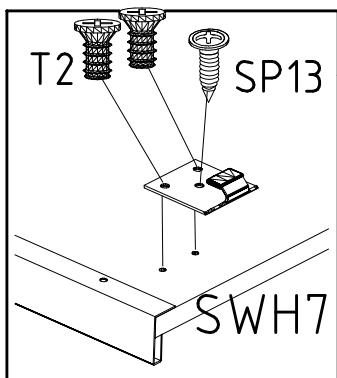
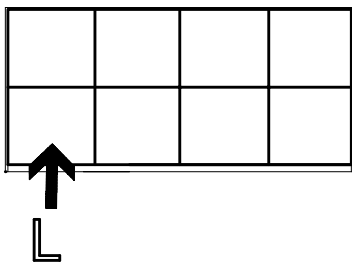
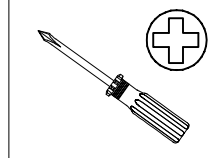
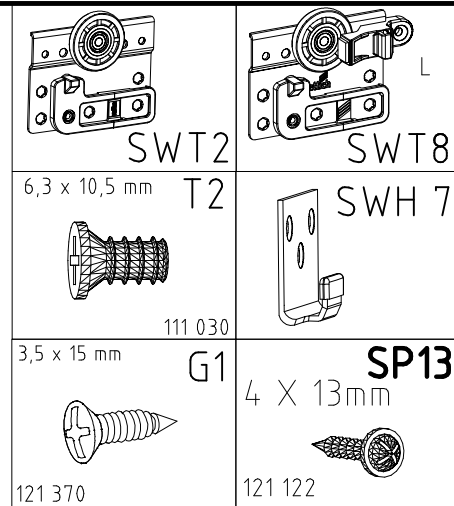
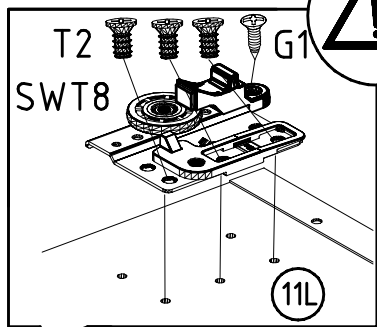
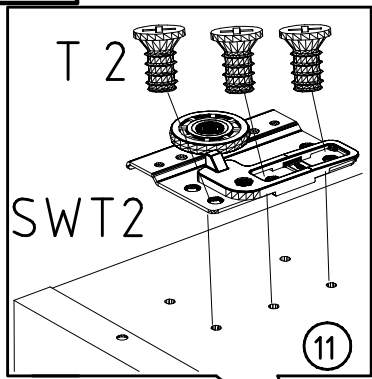

7

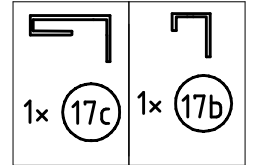
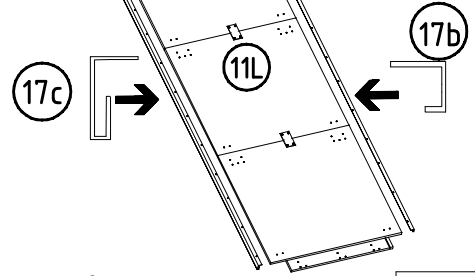
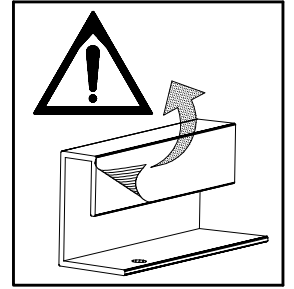
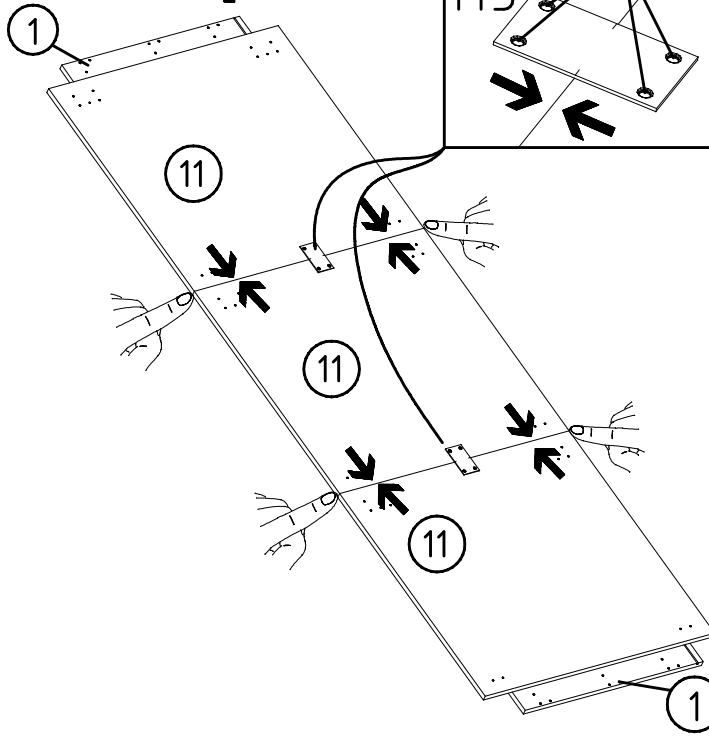
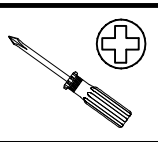
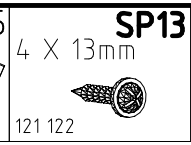
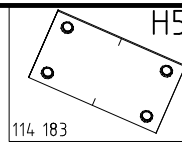
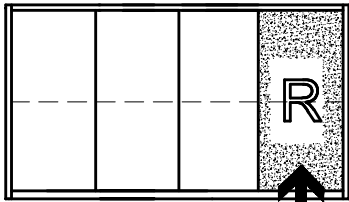

8

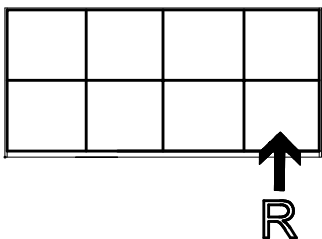
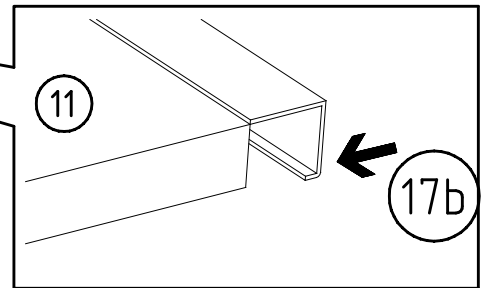
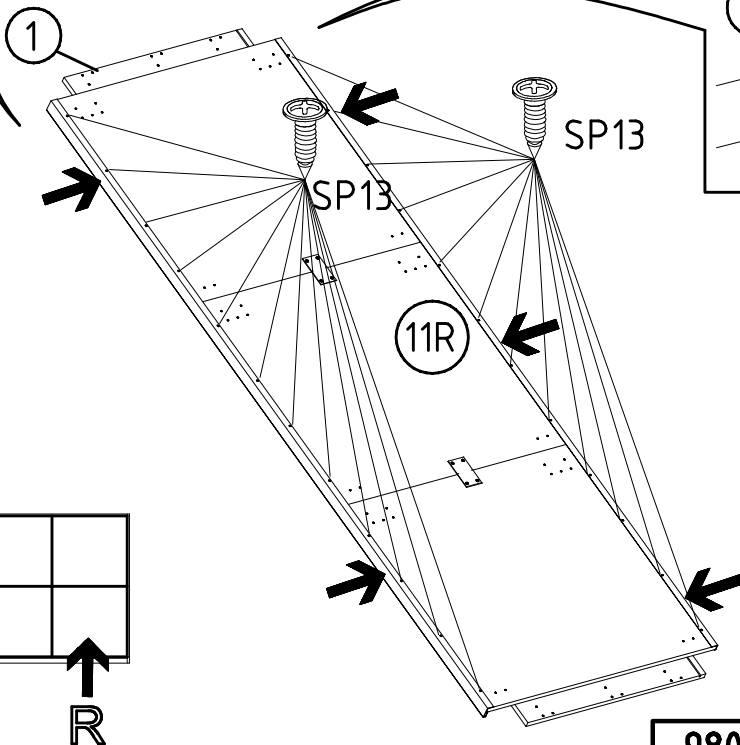
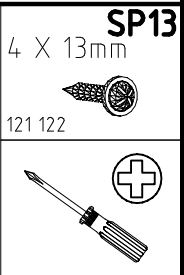
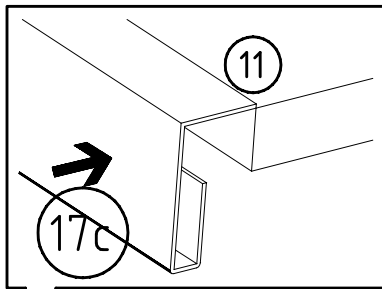

9

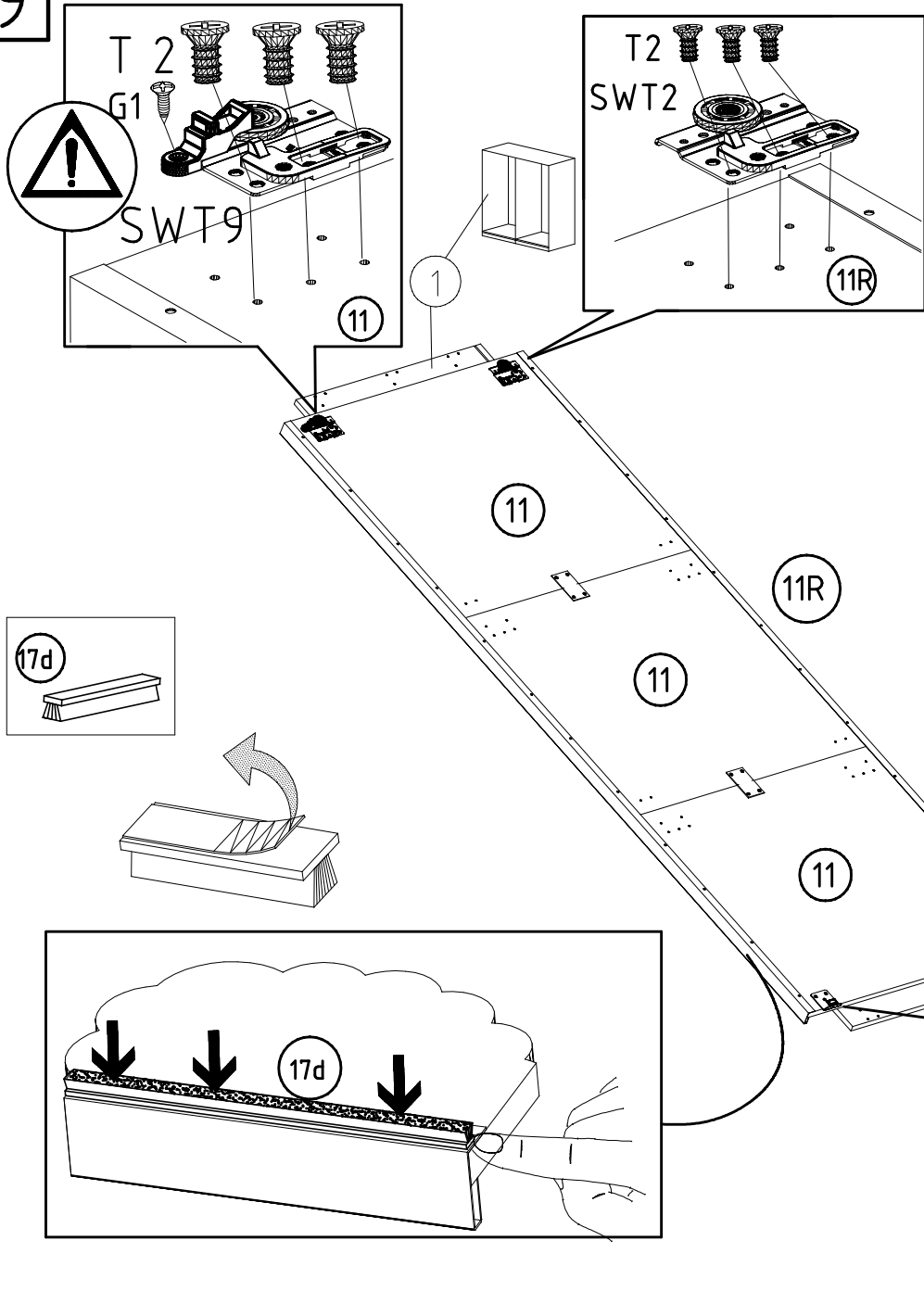

SWT2	SWT9
6,3 x 10,5 mm T2	SWH 7
111 030	
3,5 x 15 mm G1	4 X 13mm SP13
121 370	121 122

