

Sunniva
Art. Nr. 2847650
1/6

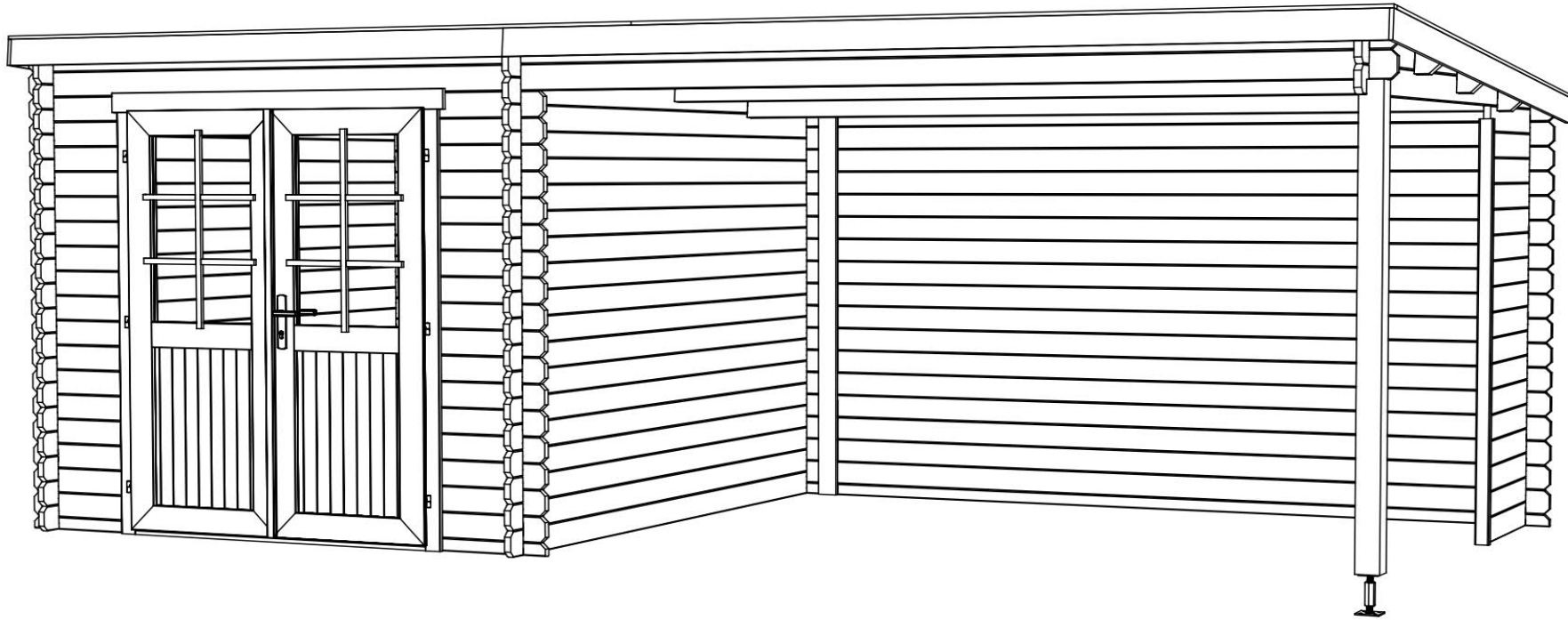

Groundplan - Grundplan - Plan de masse - Planimetria - Plattegrond - Põhiplaan

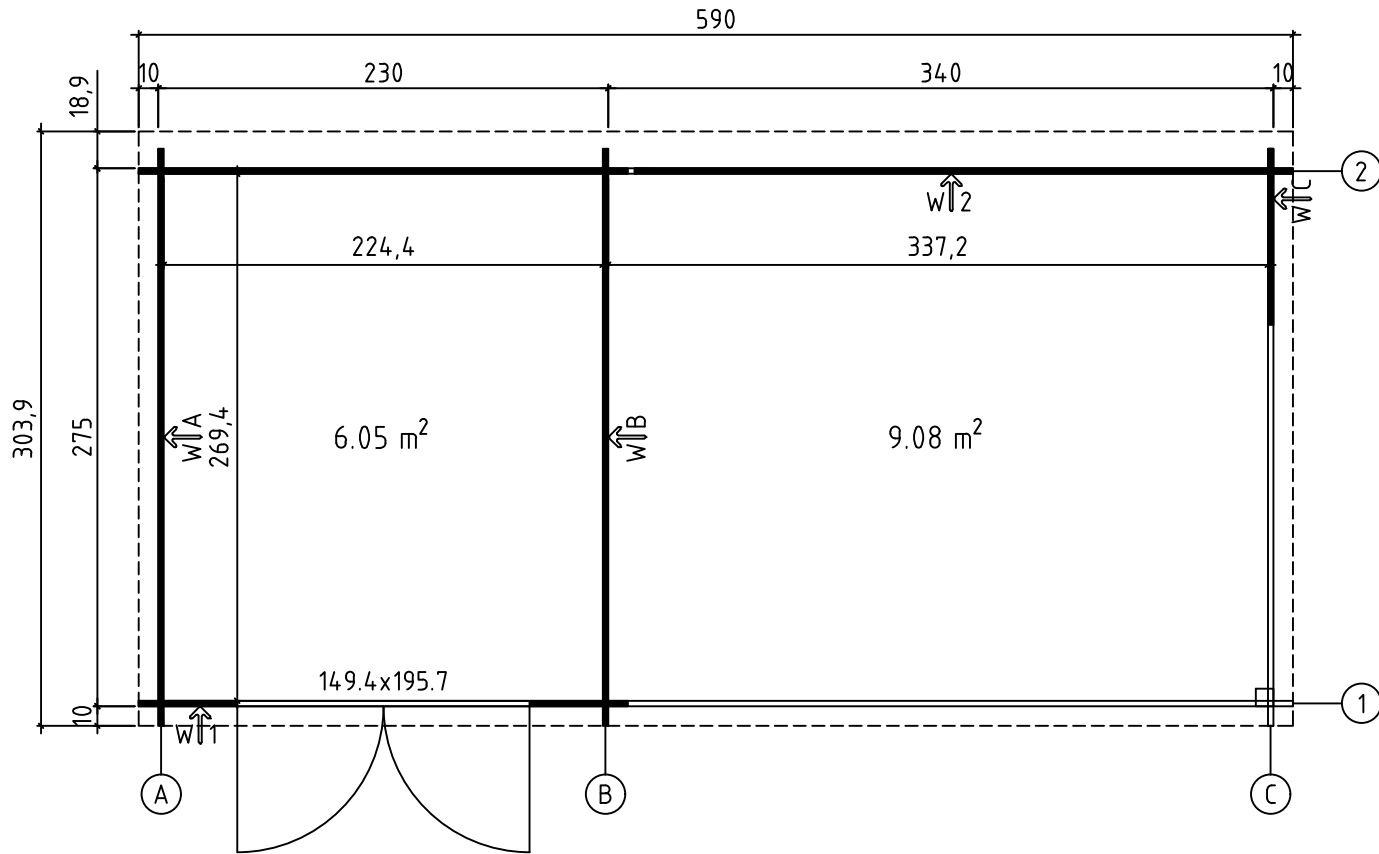



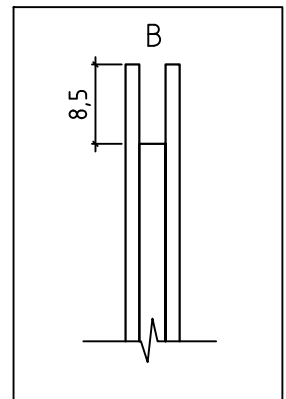
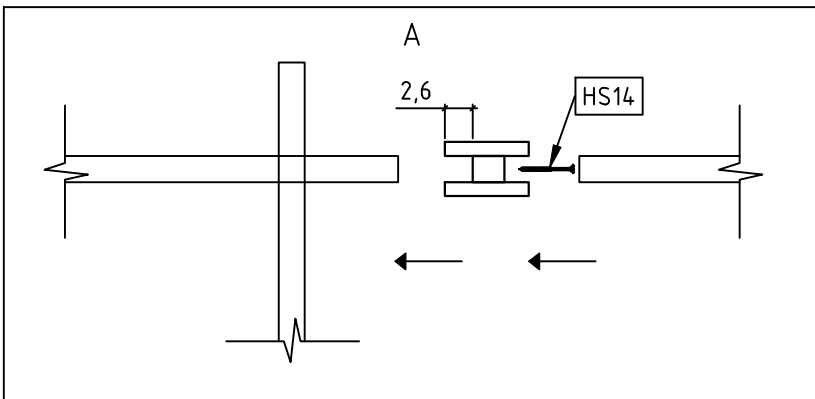
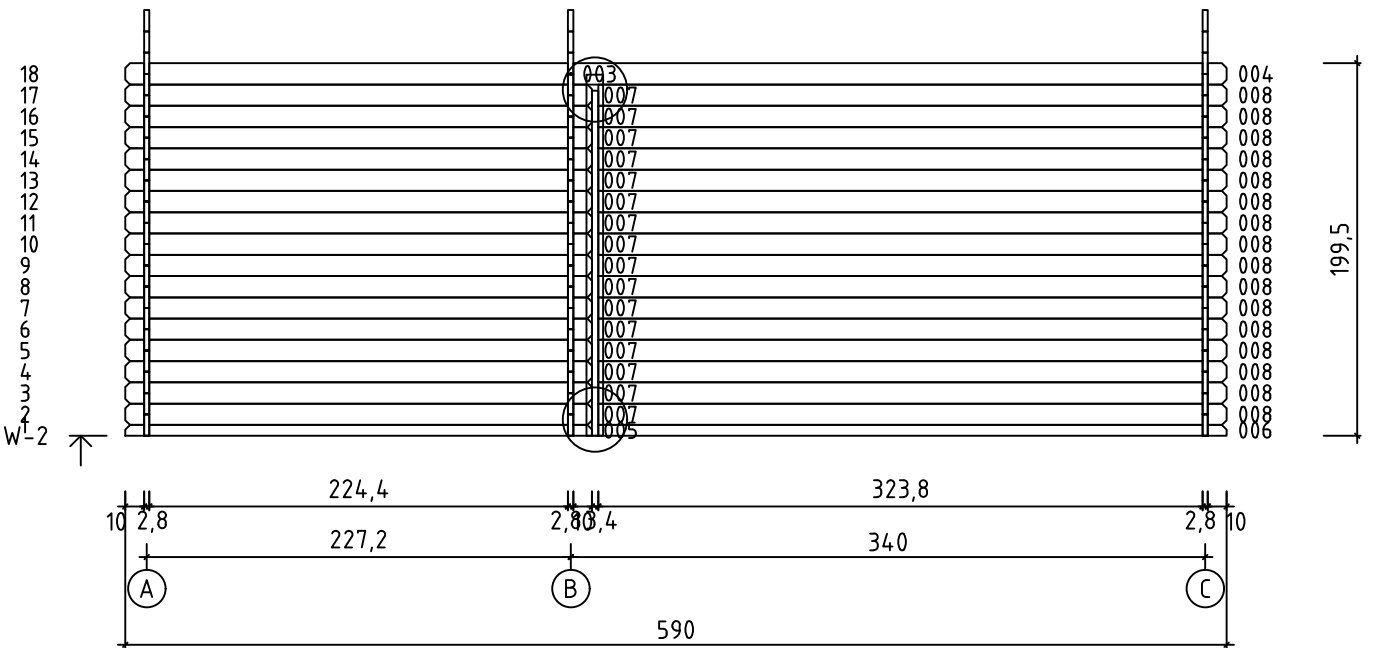
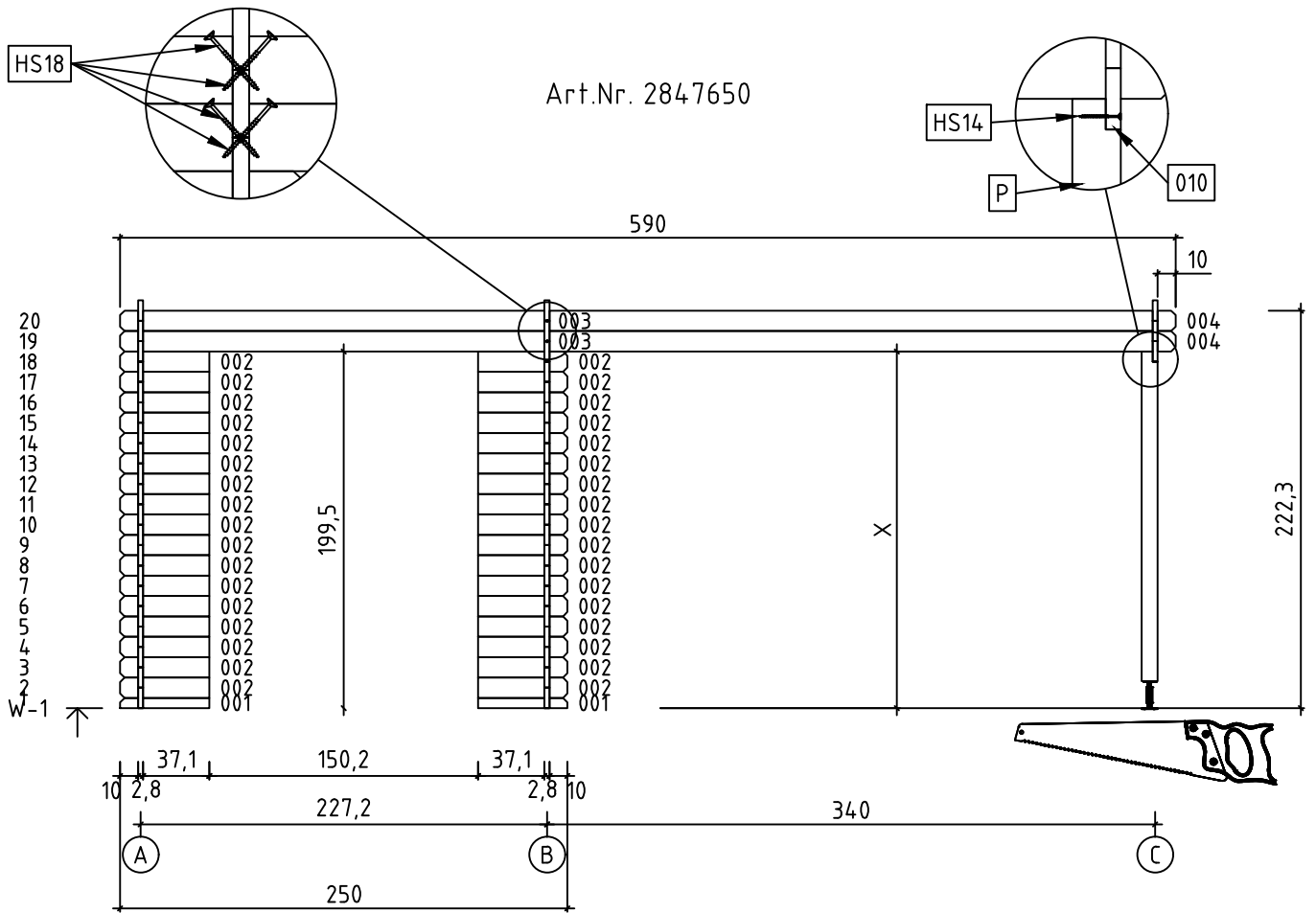



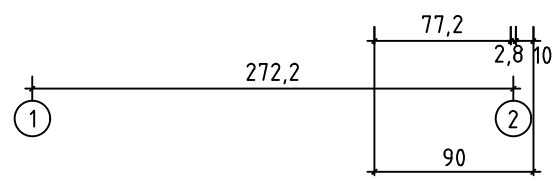
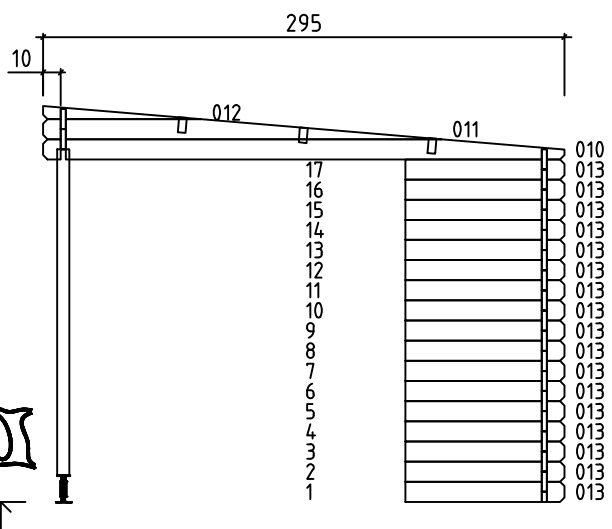
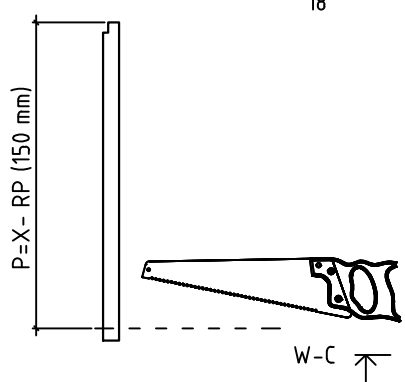
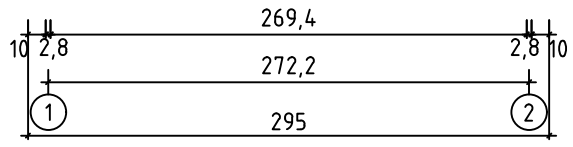
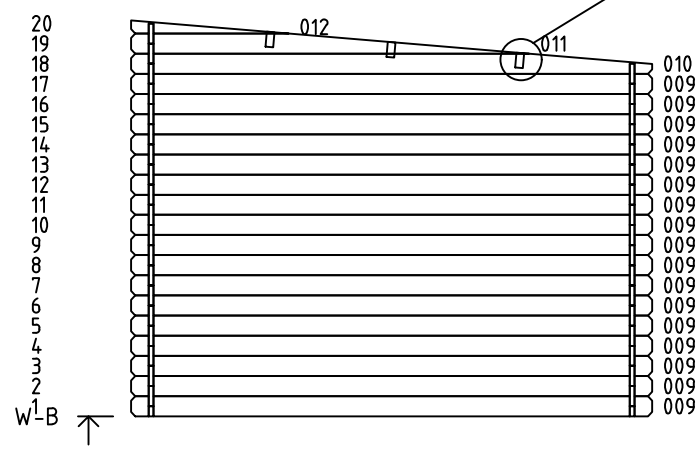
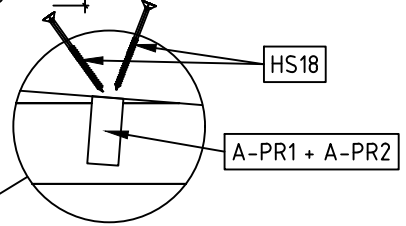
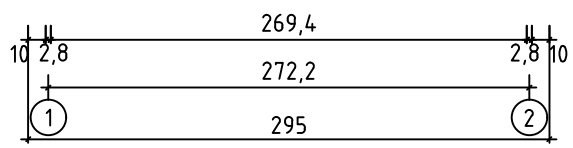
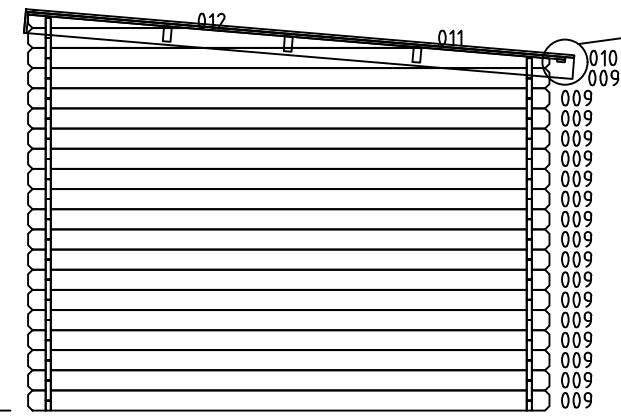
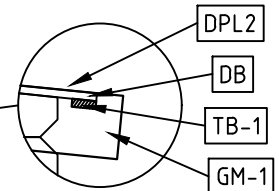
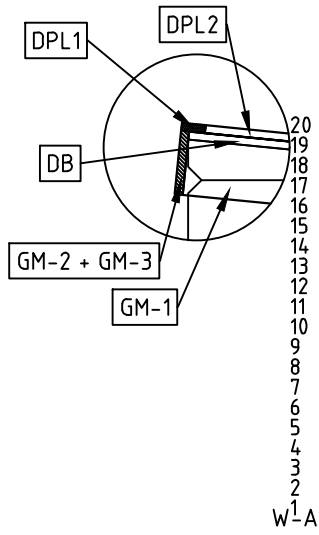



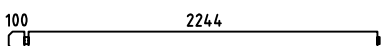
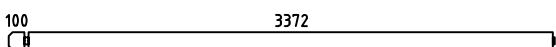
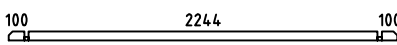
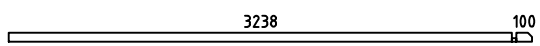
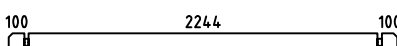
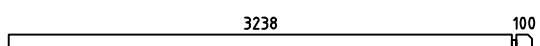
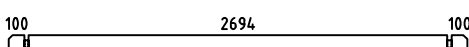
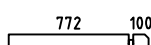
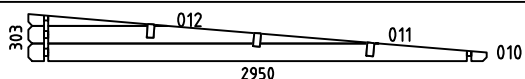
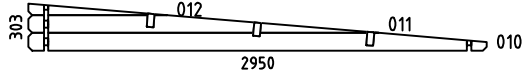
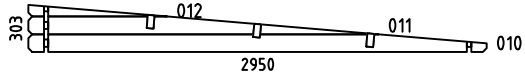
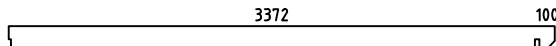
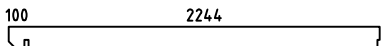
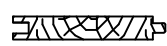

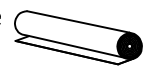
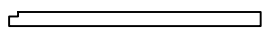

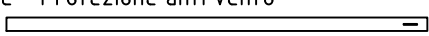

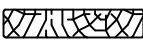
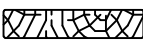
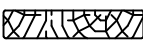
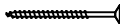
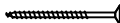
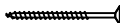
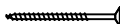
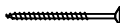
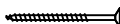

Art.Nr. 2847650







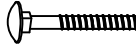

Art.Nr. 2847650

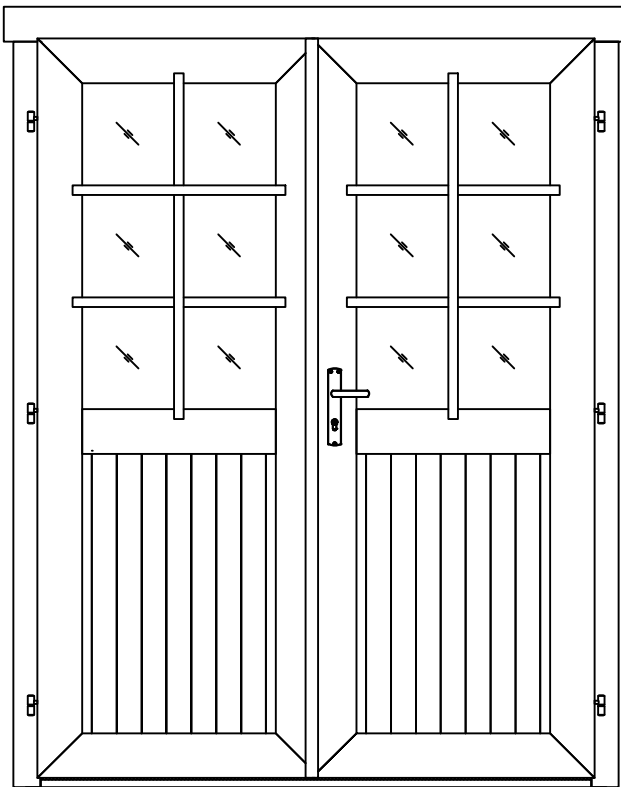
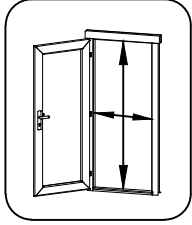
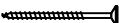
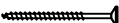
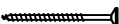

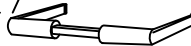
Pos	27.11.2019 Piece list - Stückliste - Liste des pièces - Elementi - Stuklijst - Tükítabel Art.Nr. 2847650 5/6	Q	P (mm)	L (mm)
001		2	28x57	499
002		34	28x114	499
003		3	28x114	2386
004		3	28x114	3514
005		1	28x57	2500
006		1	28x57	3366
007		16	28x114	2500
008		16	28x114	3366
009		34	28x114	2950
013		17	28x114	900
WA-1		1		
WB-1		1		
WC-1		1		
A-PR2	Roof beam - Dachbalken - Panne de toit - Perlina del tetto - Gordingen / dakbalk - Pärlin 	3	44x140	3514
A-PR1	Roof beam - Dachbalken - Panne de toit - Perlina del tetto - Gordingen / dakbalk - Pärlin 	3	44x140	2386
DB	Roof boards - Dachbretter - Voliges - Perlina per tetto - Dakhout - Katuselaud 	66	90x15	3050
DPL1	Roofing felt fillet - Dachpappenleiste - Baguette de fixation du feutre bitumeux - Asse per fissaggio guaina bituminosa - Afdekljst asfaltpapier - Katusepapiilist 	2	15x45	2965
DPL2	Roofing felt fillet - Dachpappenleiste - Baguette de fixation du feutre bitumeux - Asse per fissaggio guaina bituminosa - Afdekljst asfaltpapier - Katusepapiilist 	2	15x45	3070
DPP-1	Roofing felt (strip) - Dachpappe (bahnen) - Feutre bitumeux (bande) - Cartone catramato - Asfaltpapier (baan) - Katusepapp 	4		6000
P	Post - Pfosten - Poteau - Piede registrabile - Stijl - Post 	1	90x90	1890
HP	H-profile - H-profilis - Profile H - Profilo ad H - H-profiel - H-profiil 	1	90x58	1935
TB-1	Roof edge reinforcement - Dachrandverstärkung - Corniere de renfort de bord de toit - Rinforzo x tetto - Dakrand versterking - Räästatugevdus 	2	15x45	2950
KFS-1	Storm protection - Sturmleiste - Latte anti-tempete - Protezione anti vento - Stormverankering / beveiliging - Tormikinnitusliist 	5	22x45	2050

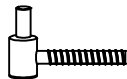
Pos	27.11.2019 Piece list - Stückliste - Liste des pièces - Elementi - Stuklijst - Tükítabel Art.Nr. 2847650 6/6	Q	P (mm)	L (mm)
	U-profile - U-profils - Profile u - Profilo ad u - U-profiel - U-profiil 	1	28x58	1880
GM-2	Gable moulding - Giebelleiste - Planche de rive - Finitura per frontale e retro del tetto - Gevellijst - Viilulaud 	1	15x120	2386
GM-1	Gable moulding - Giebelleiste - Planche de rive - Finitura per frontale e retro del tetto - Gevellijst - Viilulaud 	2	15x120	3115
GM-3	Gable moulding - Giebelleiste - Planche de rive - Finitura per frontale e retro del tetto - Gevellijst - Viilulaud 	1	15x120	3514
HS9	Screw for u-profile - Schraube zur Befestigung u-profils - Vis a tete fraisée pour profil u - Vite per profilo ad u - Schroef ter bevestiging u-profiel - Kruvi U-profiilile 	5	3.5x50	
HS9	Screw for gable moulding - Schrauben für Giebelleiste - Vis pour fixation planche de rive - Vite per fissare finiture davanti e dietro del tetto - Schroef voor gevellijst - Kruvi viilulauale 	28	3.5x50	
HS4	Screw for roof edge reinforcement - Schrauben für Dachrandverstärkung - Vis pour fixation corniere renfort de bord de toit - Viti x rinforzo bordo tetto - Schroef voor dakrand versterking - Kruvi räästatugevdusele 	14	3x30	
HS14	Screw for post - Schrauben für Pfosten - Vis de fixation des poteaux - Viti per inviare - Schroef voor stijlen - Kruvi postile 	2	4.5x80	
HS14	Screw for wall details - Schraube für Wand details - Vis pour mur details - Viti per elementi della porta - Schroef voor wand details - Kruvi seinte montaažiks 	1	4.5x80	
HS18	Screw for roof beams - Schrauben für Dachbalken - Vis pour fixation pannes de toit - Viti per perline del tetto - Schroef voor gordingen / dakbalken - Kruvi pärlinitele 	12	5x120	
HS18	Screw for wall details - Schraube für Wand details - Vis pour mur details - Viti per elementi della porta - Schroef voor wand details - Kruvi seinadetailidele 	6	5x120	
HS18	Screw for gable - Schrauben für Giebel - Vis pour fixation des pignons - Viti per timpano - Schroef voor gevelpunt - Kruvi viilude kinnitamiseks 	6	5x120	
HS20	Screw for post height adjustment - Schrauben für regulierungsschraube für Pfosten - Vis de fixation de support réglable de poteau - Viti per fissare ed aggiustare l'altezza del palo verticale - Schroef voor hoogte instelling stijlen - Kruvi vajumispolidile 	8	6x50	
SH28	Hammer block - Schlagholz - Calle de frappe - Blocco di legno da usare come cuscinetto quando si usa il martello - Slagklos - Löögiklots 	1		
SFS	Nut for storm protection - Schraubenmutter für Sturmleiste - Erou pour latte anti-tempete - Dado x asta protezione vento - Moer voor stormverankering - Mutter tormikinnitusliistule 	10	D6	
NF4	Zn nail for roof - Zn Nägel für Dachbretter - Pointe pour fixation voliges de toit - Chiodi x perline tetto - Spijker(nagel) voor dakhout - Nael katuselauale 	414	2x50	
NF5	Zn nail for roofing felt fillet - Zn Nägel für Dachpappenleiste - Pointe pour baguette de fixation feutre bitumeux - Chiodi x carta bituminosa x tetto - Spijker(nagel) voor asfaltpapier afdeklijst - Papiliistunael 	28	2x40	
NF6	Roofing nails for roofing felt - Nägel für Dachpappe - Pointe pour fixation feutre bitumeux - Chiodi per cartone catramato - Asfalt-nagel - Papinael 	205	2.8x15	
BFS	Bolt for storm protection - Bolzen für Sturmleiste - Boulon pour latte anti-tempete - Bullone x asta protezione vento - Bout voor stormankerlat - Puidupolt tormikinnitusliistule 	10	6x60	
DFS	Washer for storm protection - Dichtscheibe für Sturmleiste - Rondelle pour latte anti-tempete - Rondella x asta protezione vento - Afdichtring voor storm strip - Seib tormikinnitusliistule 	10	D6	
RP	Post height adjustment - Pfostenträger verstellbar - Support réglable de poteau - Piede registrabile in altezza - Stelschroef voor stijlpot - Vajumispolt 	1	D20	
	Door - Tür - Porte - Porte - Deur - Uks 1494x1957 TUK.2.056.SVP.MMb SGC	1		

Pos	13.01.2017	Piece list - Stückliste - Liste des pièces - Elementi - Stuklijst - Tükítabel 14.94x1957 TUK.2.056.SVP.MMb SGC	1/1	Q	P (mm)	L (mm)
		Glass size - Glasgröße - Taille de la vitre - Misura del vetro - Glas afmeting - Klaasi mõõt: 514x855 mm				
						
		 1394x1875 mm				
HS1	Screw for georgian bars - Schraube für sprossen - Vis pour croisillons - Viti per unire la griglia georgiana della finestra - Schroeven voor raamverdeling - Kruvi ukse peffeliistule		12	2.5x20		
HS4	Screw for door fillet - Schraube zur Befestigung türleiste - Vis pour fixation baguette d'arret de porte - Viti per massellino della porta - Schroef voor deurlijst - Kruvi ukse kokkuvaltšiliistule		5	3x30		
HS16	Screw for door jamb - Schraube für Türrahmen - Vis de fixation partie haute avec montants du cadre de porte - Viti x fissaggio montanti porte - Schroef voor deurkozijn - Kruvi ukse lengile		4	5x90		
HS25	Screw for doorstep - Schrauben für swelle - Vis pour fixation barre de seuil - Vite per soglia della porta - Schroef voor deurdorpel - Kruvi lävepakule		3	4.5x65		
TL4	Door handle fittings - Türgriff - Poignée de porte - Maniglie - Deurhendel / klink - Ukse käepide		1			
TL5	Set of door lock covers - Schlossblenden - Set de garnitures de porte - Copertura serrature - Slot sluitplaat set - Ukse lukuplaat		1			
	Cylinder lock - Zylinderschloss - Barillet de porte - Serratura - Cylinder slot - Ukse lukusüdamik		1	30x35		
	Male bolt hinge for door - Türband - Partie male de paumelle de porte - Cerniera anube x porta - Scharnier bout - Ukse polthing isane		6			
	Striker for barrel bolt - Hülse für Grendelriegel - Gache au sol du targette - Boccola per fermo della porta - Huls voor vergrendelingsschuif - Vasturaud ukse servariivile		2			