

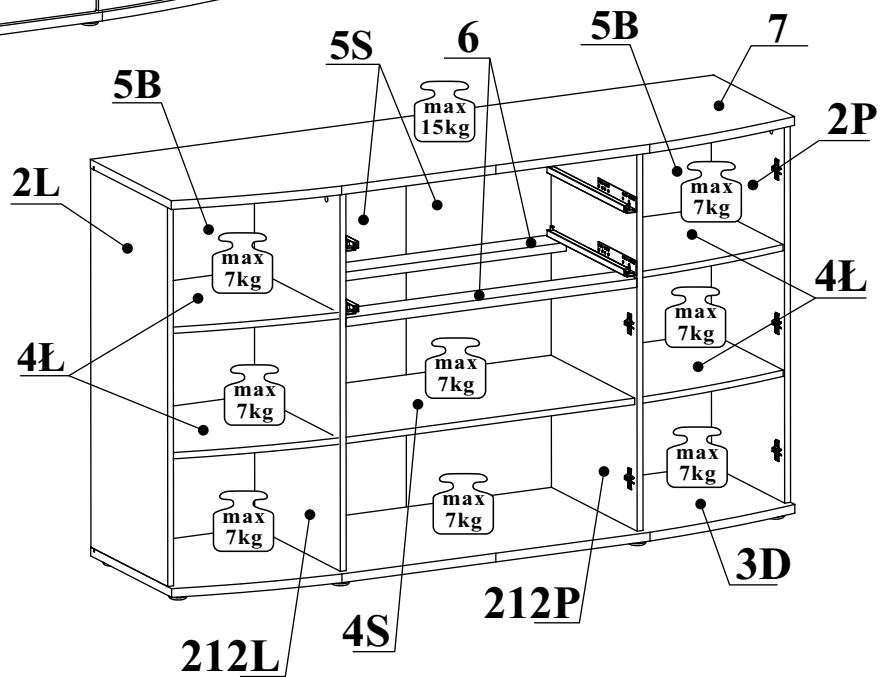

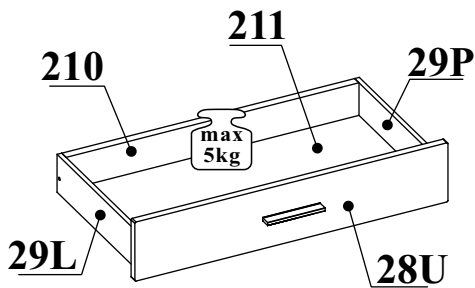

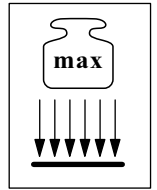

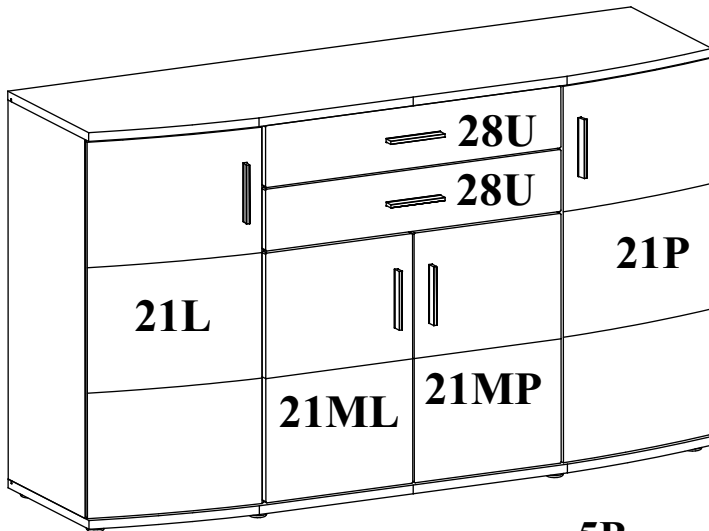

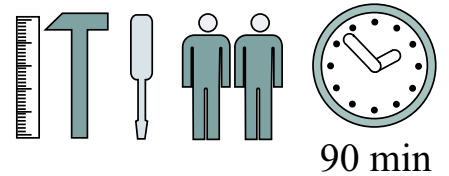

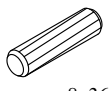
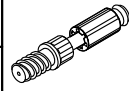

JAM TYP 20 1061WT_20

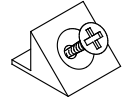
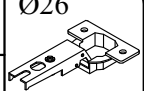
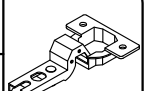
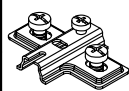
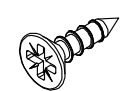
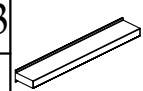
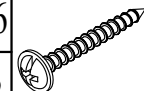

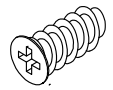
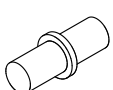
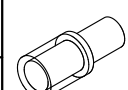
NO	Dim.	Col.-No	Qty
21L	443 948	2	1
21P	443 948	2	1
21MP	401 629	2	1
21ML	401 629	2	1
2L	955 410	3	1
212L	955 457	2	1
212P	955 457	2	1
2P	955 410	3	1
3D	1701 500	1	1
4L	421 447	3	4
4S	793 447	3	1
5B	967 435	1	2
5S	967 405	1	2
6	794 80	3	2
7	1701 500	1	1
28U	806 156	2	2
29L	400 100	1	2
29P	400 100	1	2
210	754 86	3	2
211	767 403	3	2

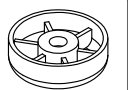
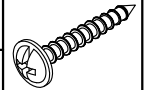
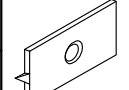

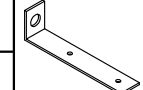
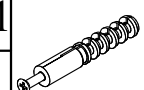

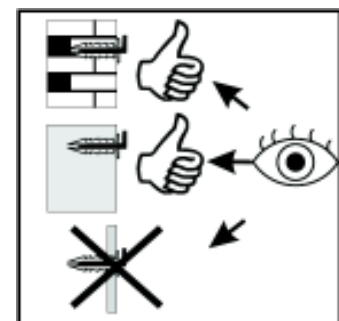
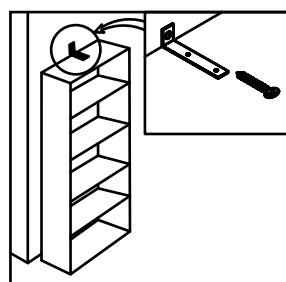
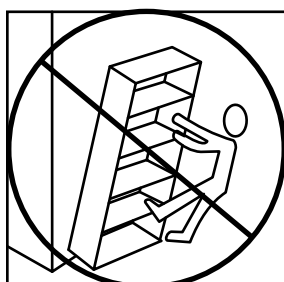
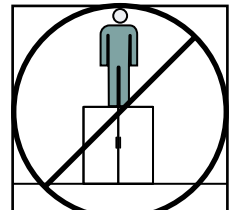
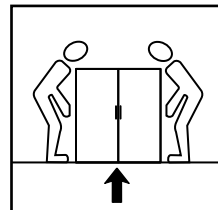
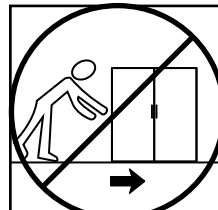
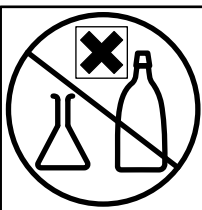
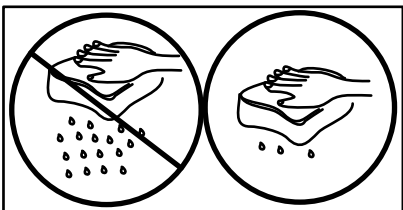
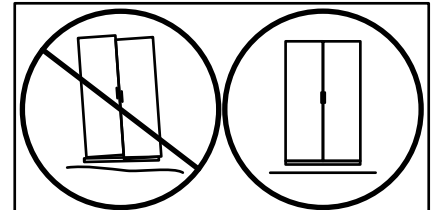
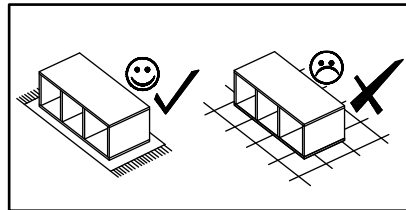
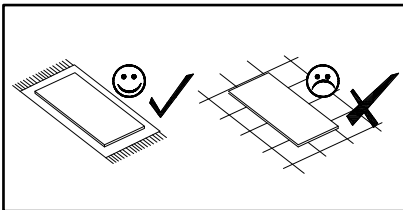
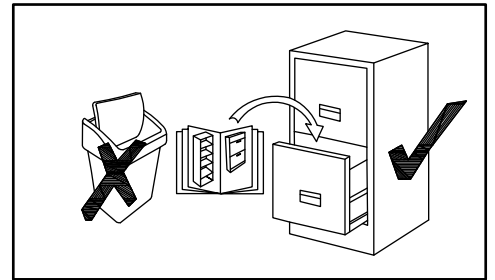
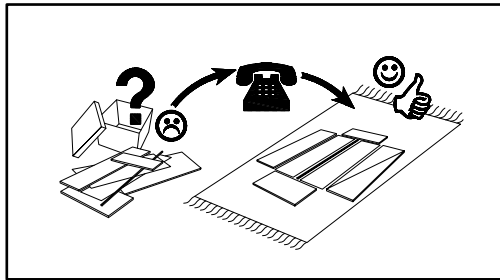
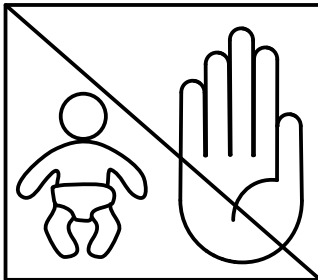
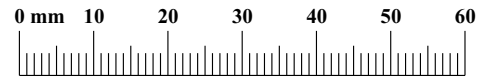

90 min

A1 x28  ø8x36	B4 x16 	B5 x12  ø15x12	B16 x4  ø15x16	G5 x16 	S1 x26 
E1 x6 Ø26 H=0 	E3 x4 H=8 	E2 x10 H=0 	D10 x32 USØ3,5x13 	BG3 x6 L-128mm 	UP16 x12 UPØ4x35 
QU x2 L-400mm 	D20 x8 ESØ6x9,5 	G7 x20 	G20 x2 	B11 x12 Ø7x50 	G4 x12 
I11 x8 Ø50, h=25 	UP15 x8 UPØ4x25 	G16 x12 	UP13 x22 UPØ3x16 	L1 x2 	KR1 x2 
G2 x1 					

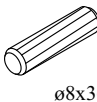
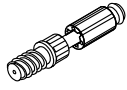

JAM TYP 20

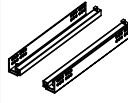
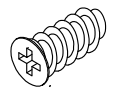
1

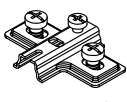
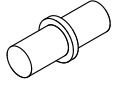
A1 x8	 ø8x36	B4 x4		B5 x4	 ø15x12
QU x2	 L=400mm	D20 x8	 ESØ6x9,5	D10 x8	 USØ3,5x13
E2 x4	 H=0	G7 x12			

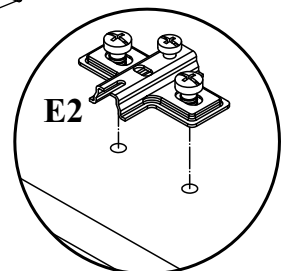
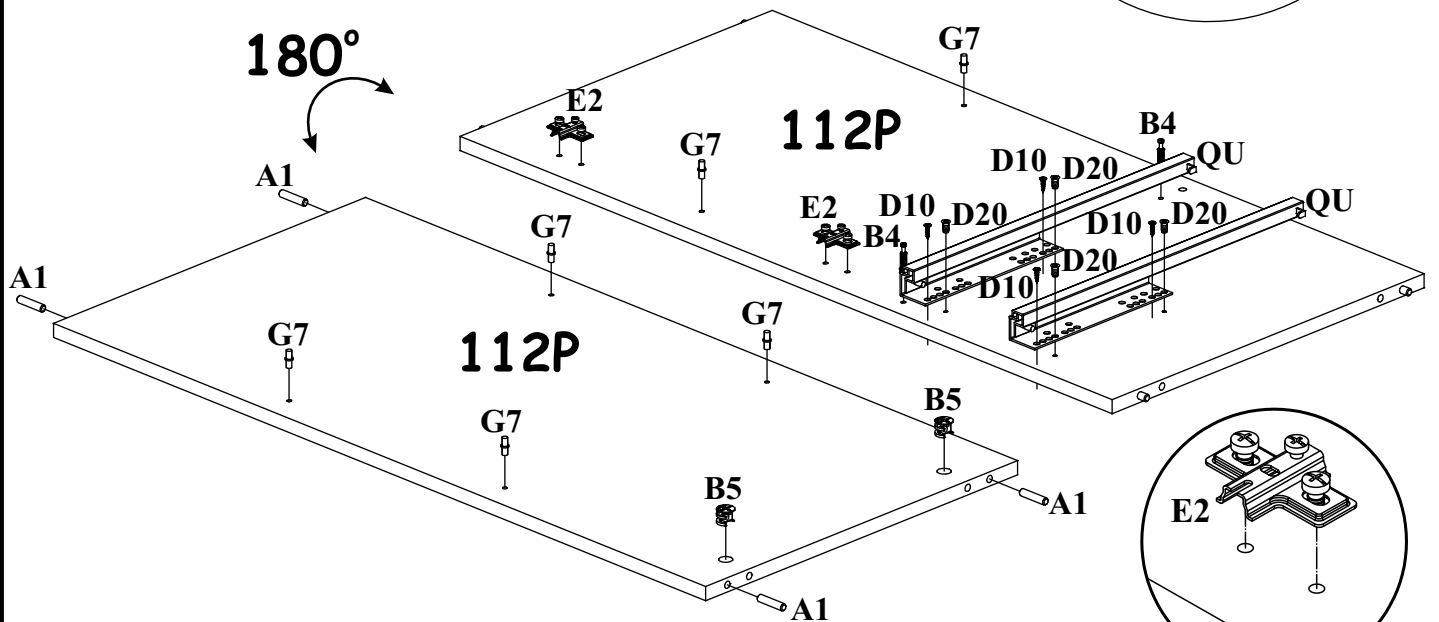
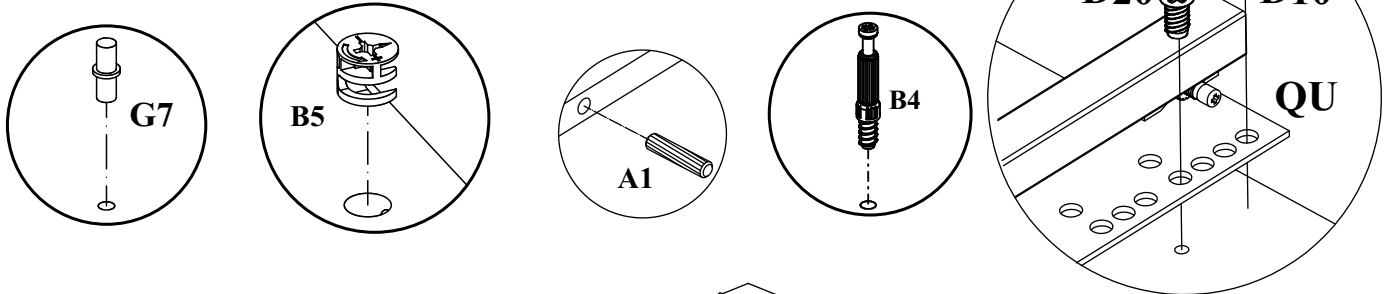
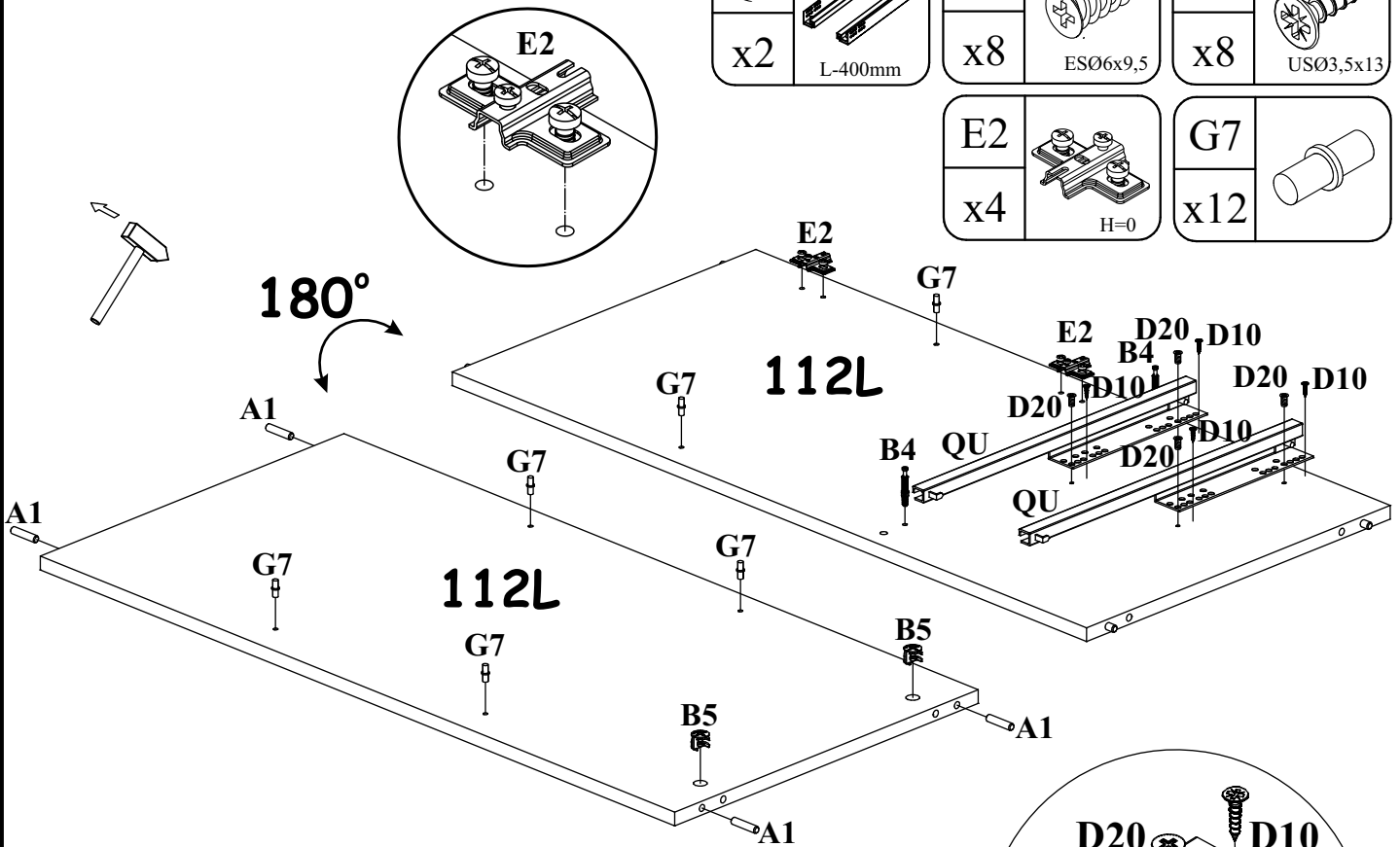

JAM TYP 20

2

A1	
x8	ø8x36

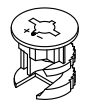
B5	
x4	ø15x12

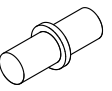
G7	
x8	

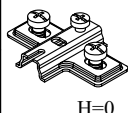
E2	
x6	H=0

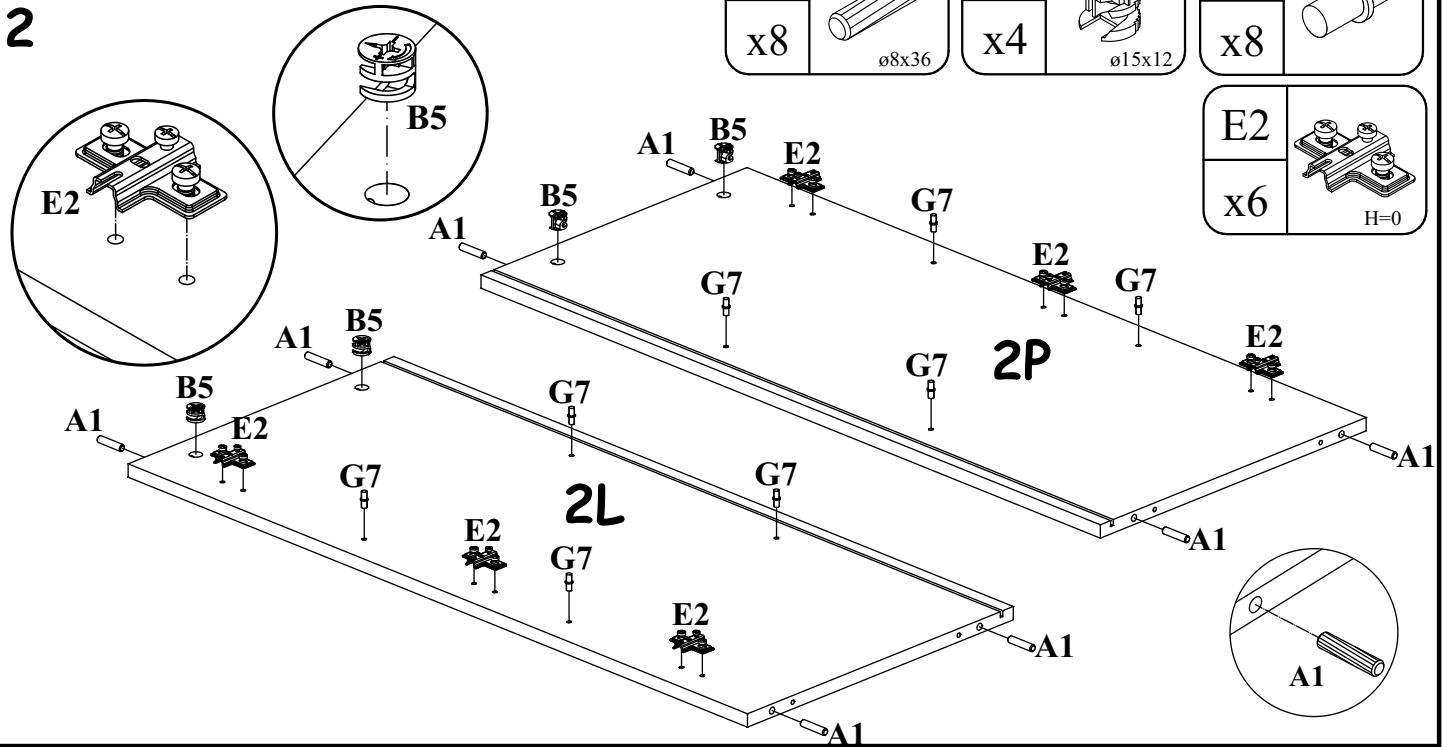

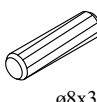

3

A1	
x4	ø8x36

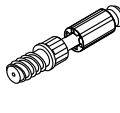
B16	
x4	Ø15x16

B4	
x8	

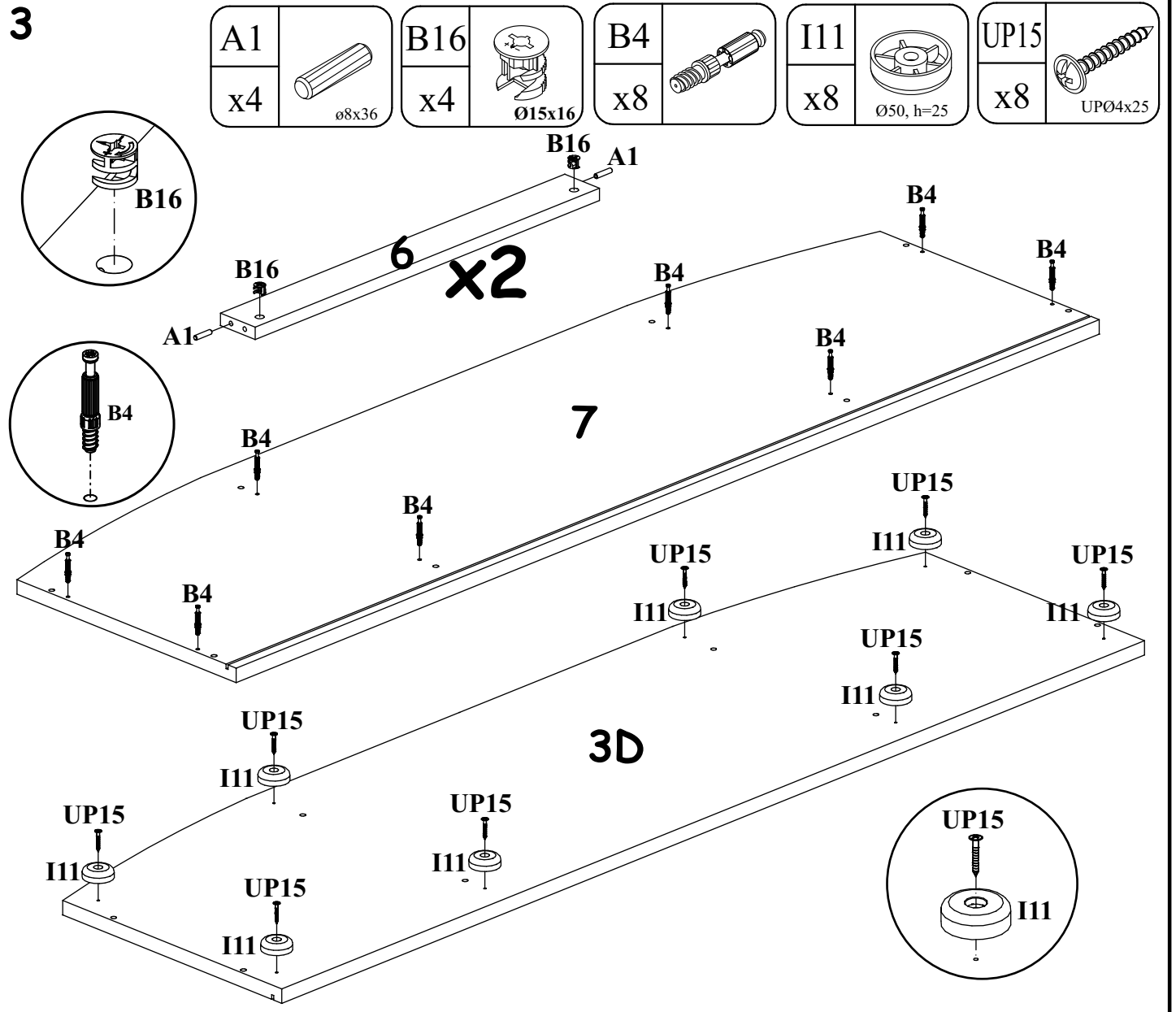

I11	
x8	Ø50, h=25

UP15	
x8	UPØ4x25





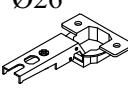
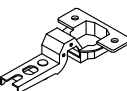
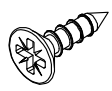
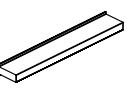

JAM TYP 20

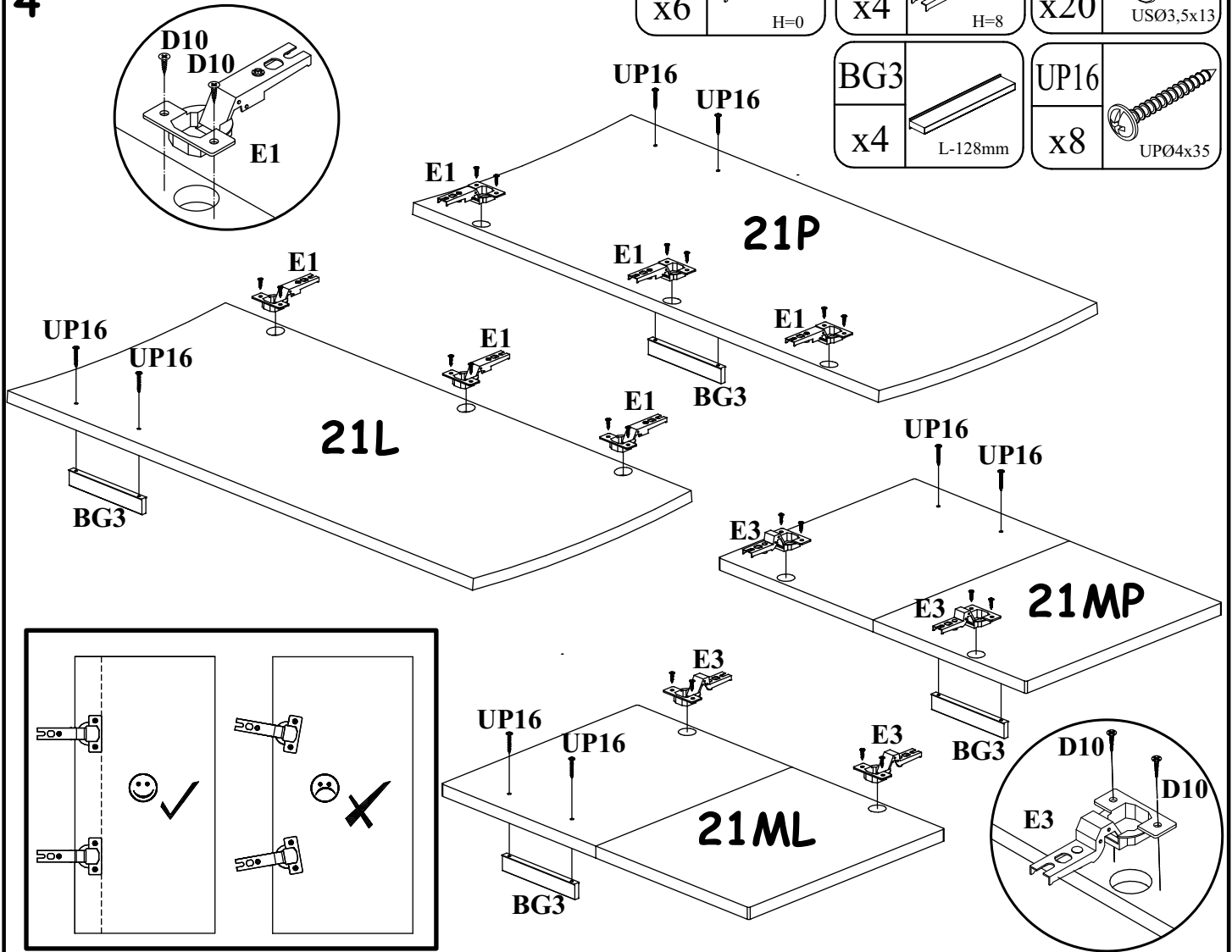
4

E1	Ø26  H=0	E3	 H=8	D10	 USØ3,5x13
x6		x4		x20	
BG3	 L=128mm	UP16	 UPØ4x35		
x4		x8			

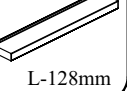

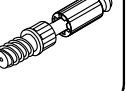
5

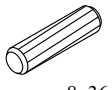
BG3	 L=128mm	UP16	 UPØ4x35
x2		x4	
B4		B5	 ø15x12
x4		x4	
A1	 ø8x36		
x8			

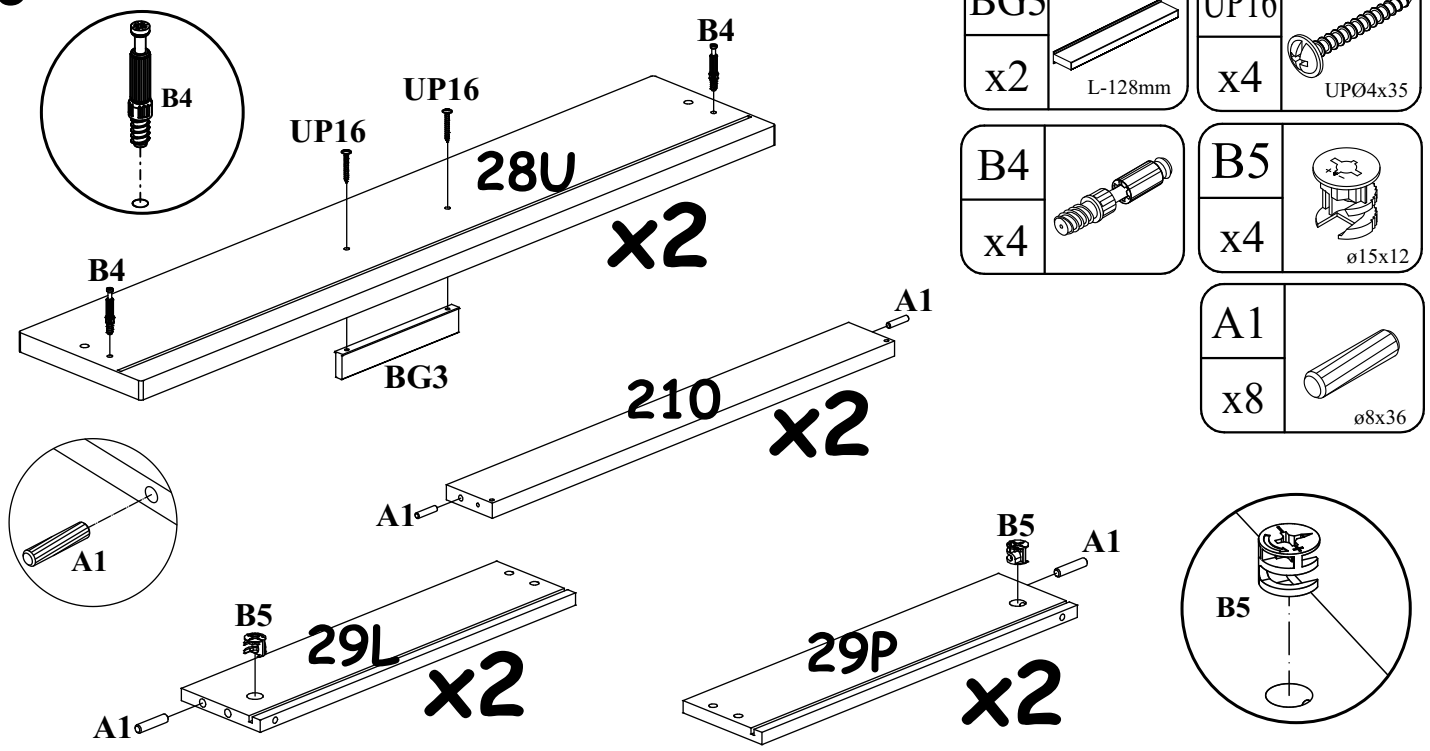

6

G5	
x4	

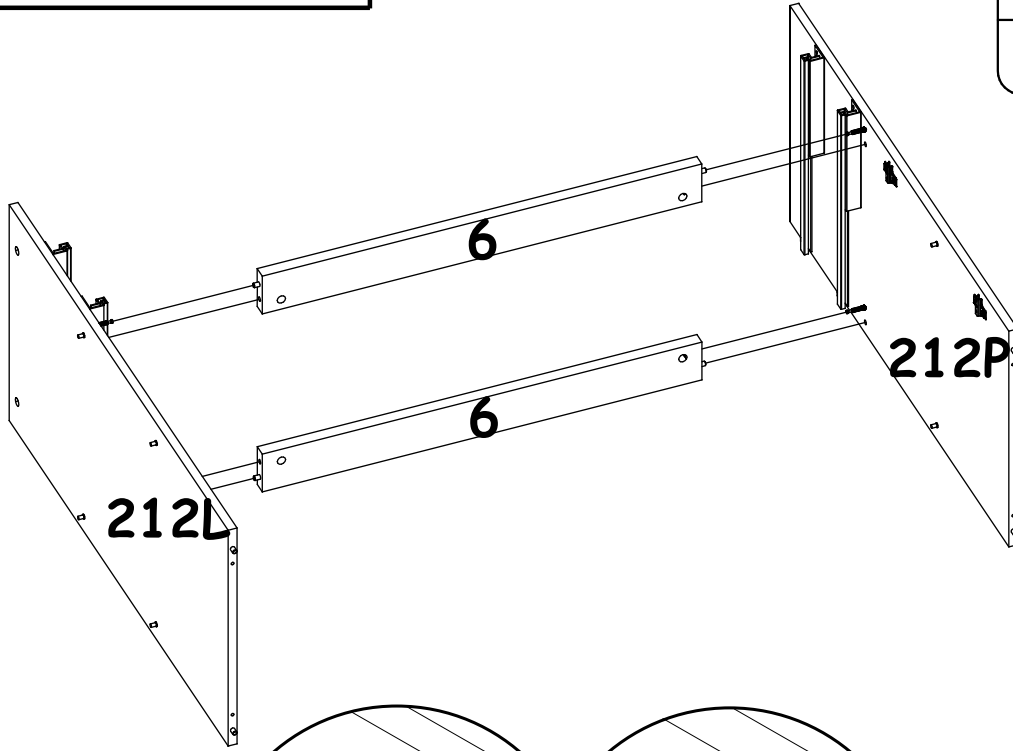

7

B4

B5

G5

G5	
x8	

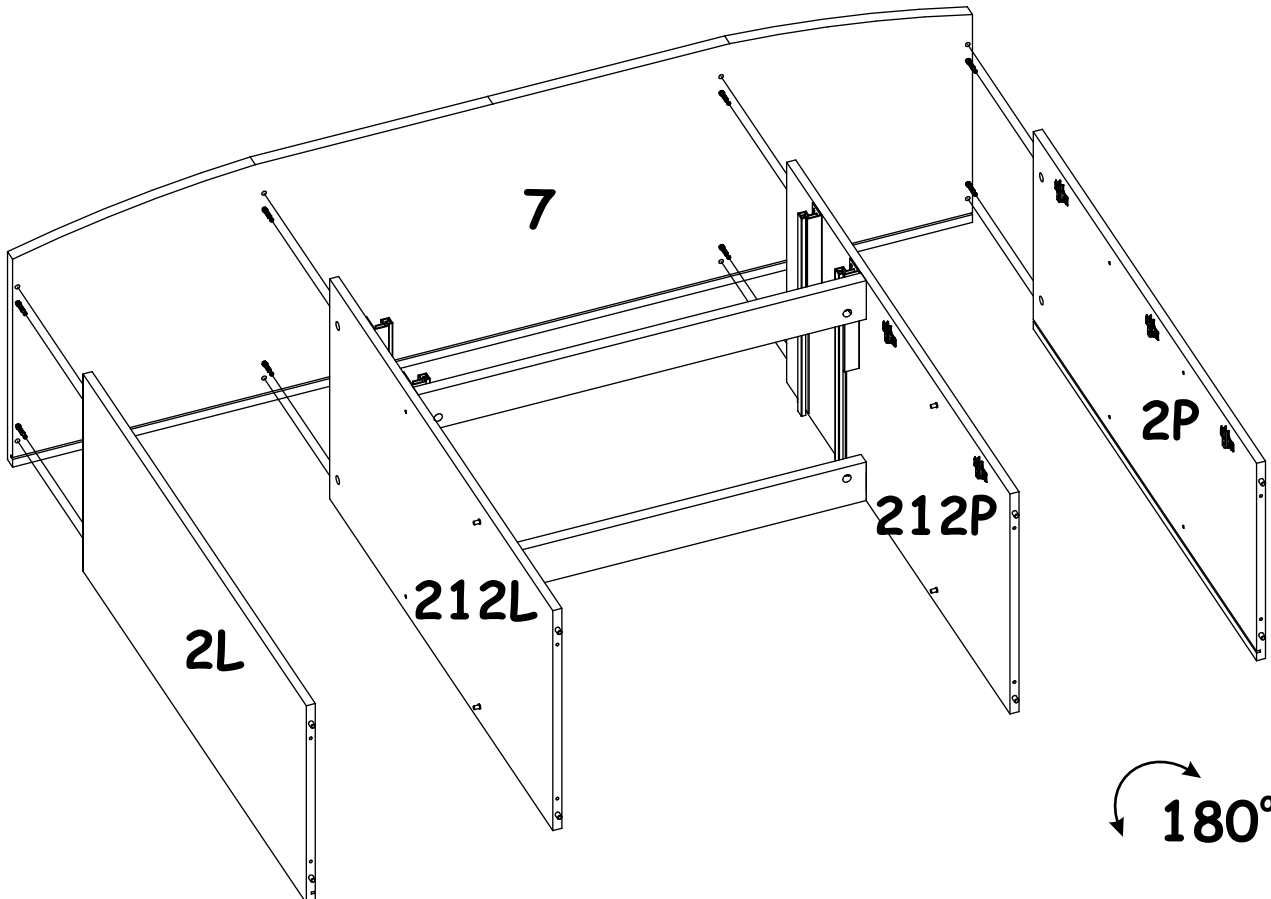

180°

JAM TYP 20

8

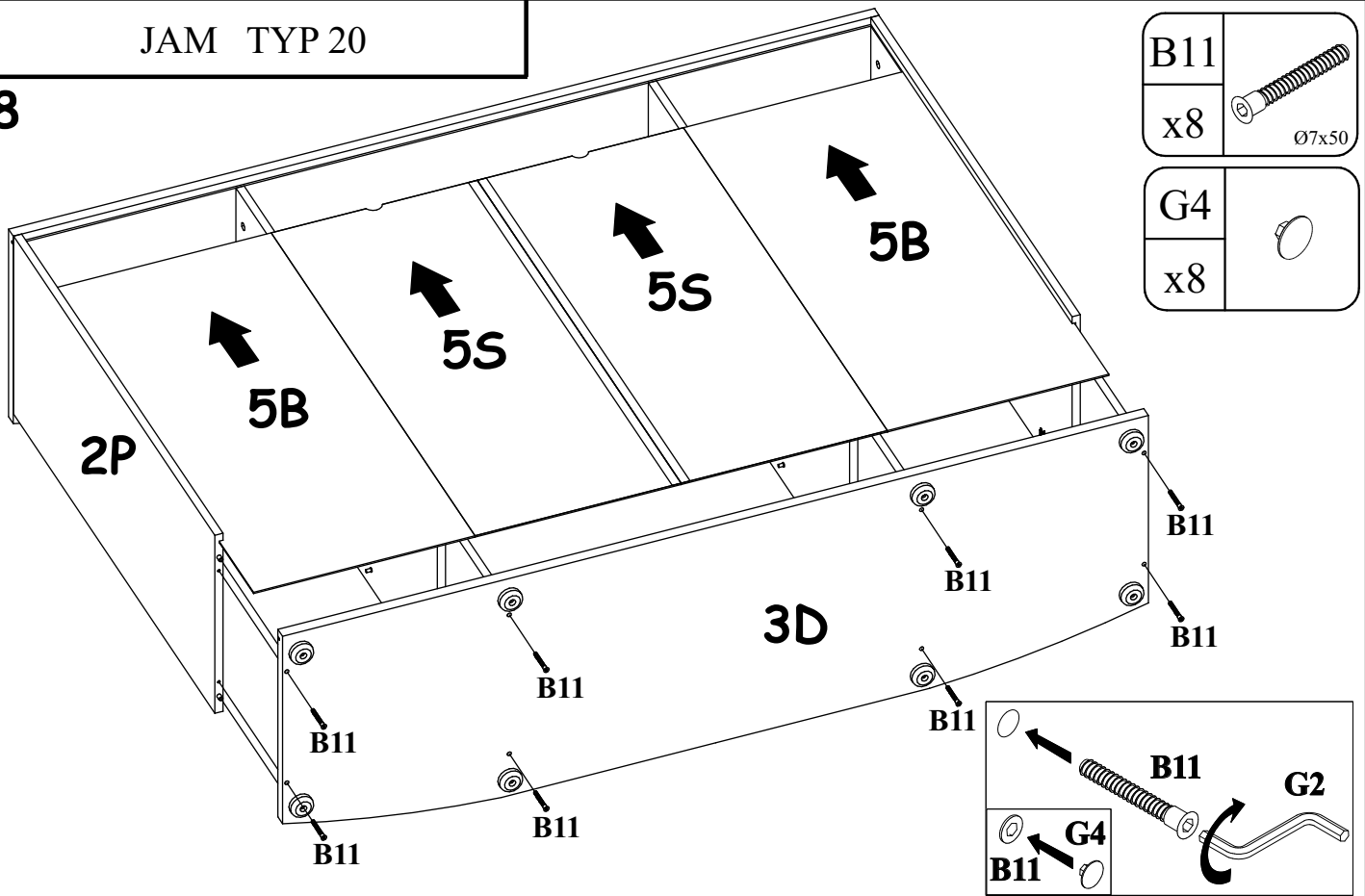

9

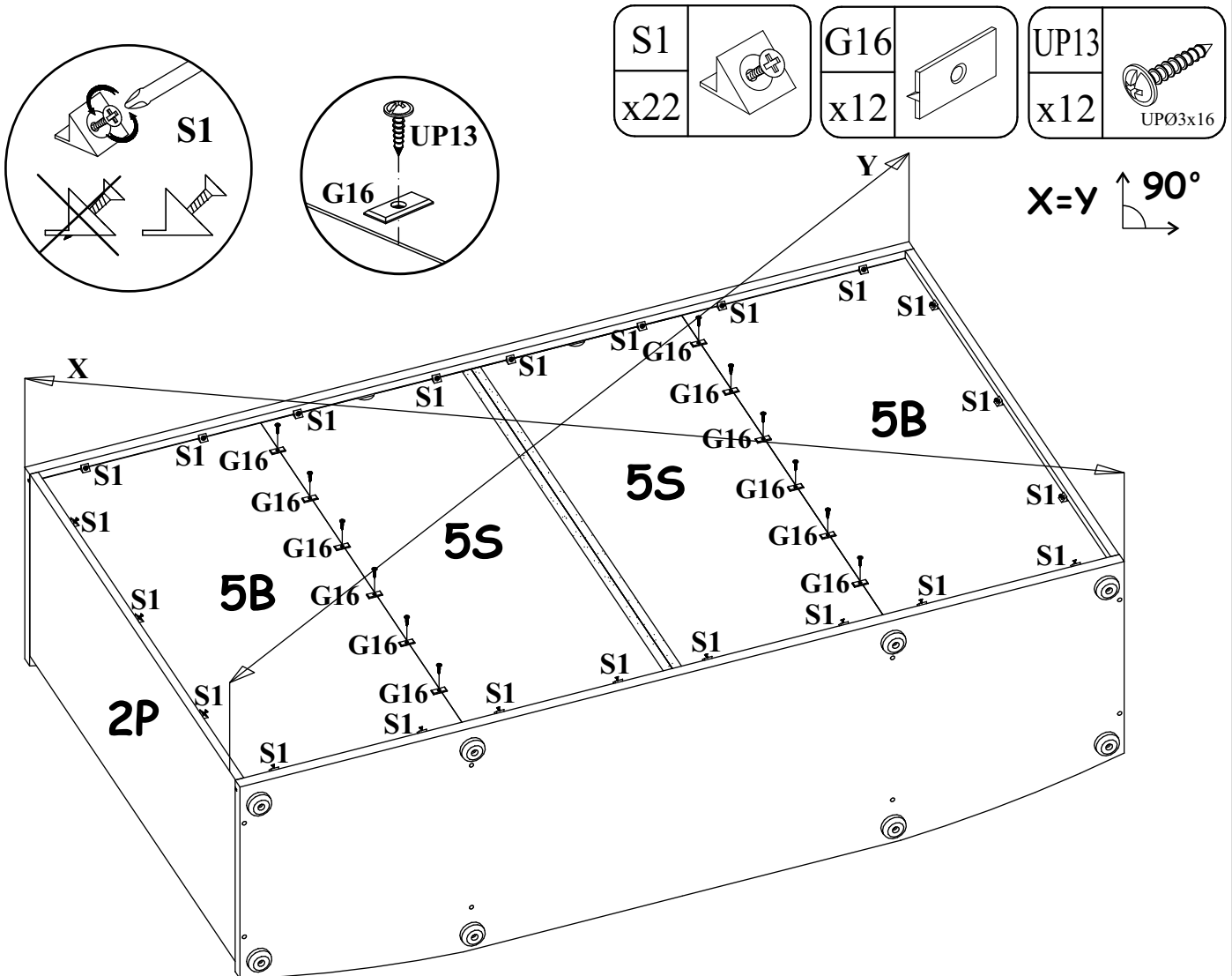

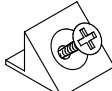

JAM TYP 20

G5	
x4	

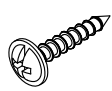
S1	
x4	

UP13	
x10	UPØ3x16

B11	
x4	Ø7x50

G4	
x4	

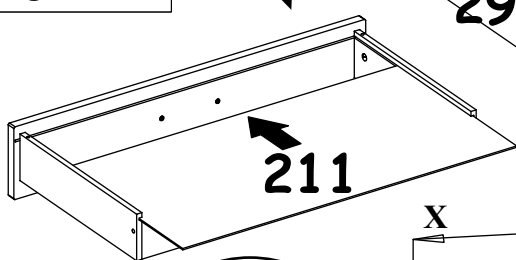
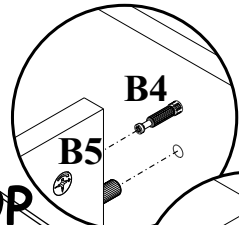
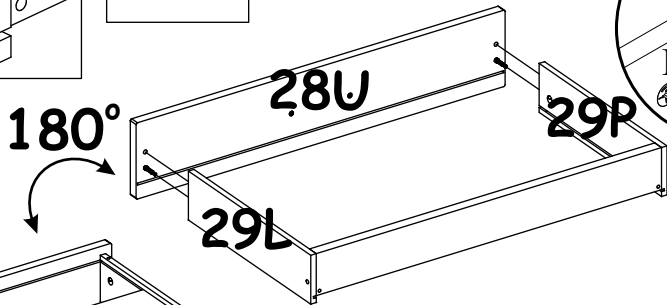
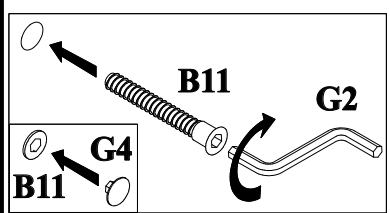
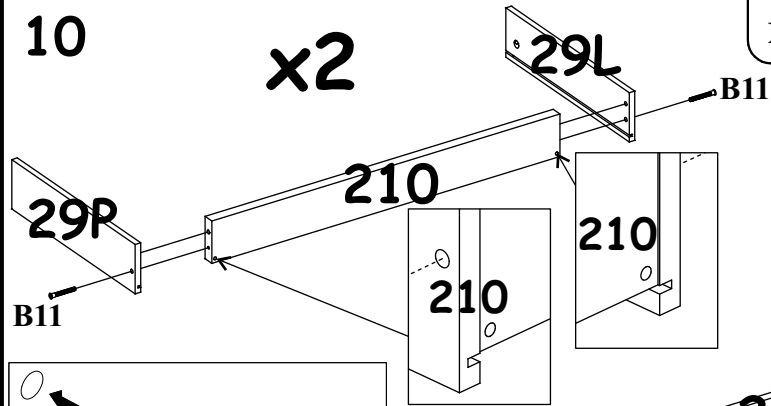

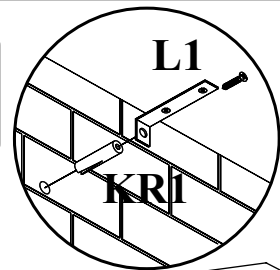
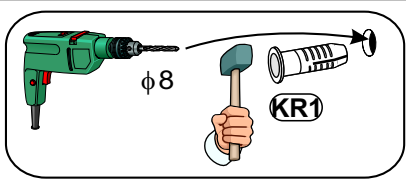
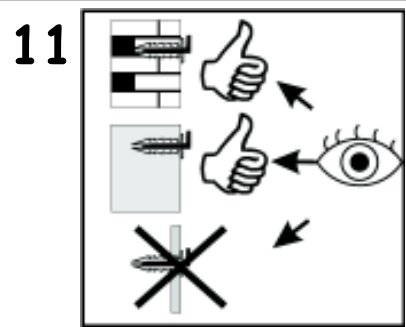
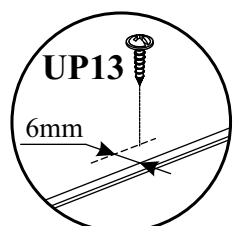
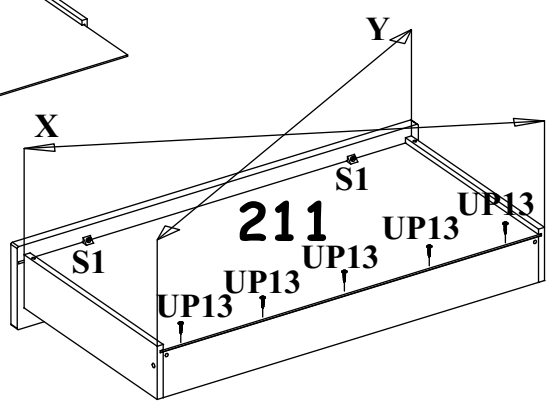
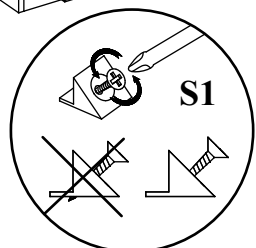

X=Y 90°

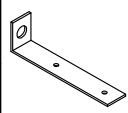

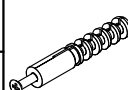
L1	
x2	

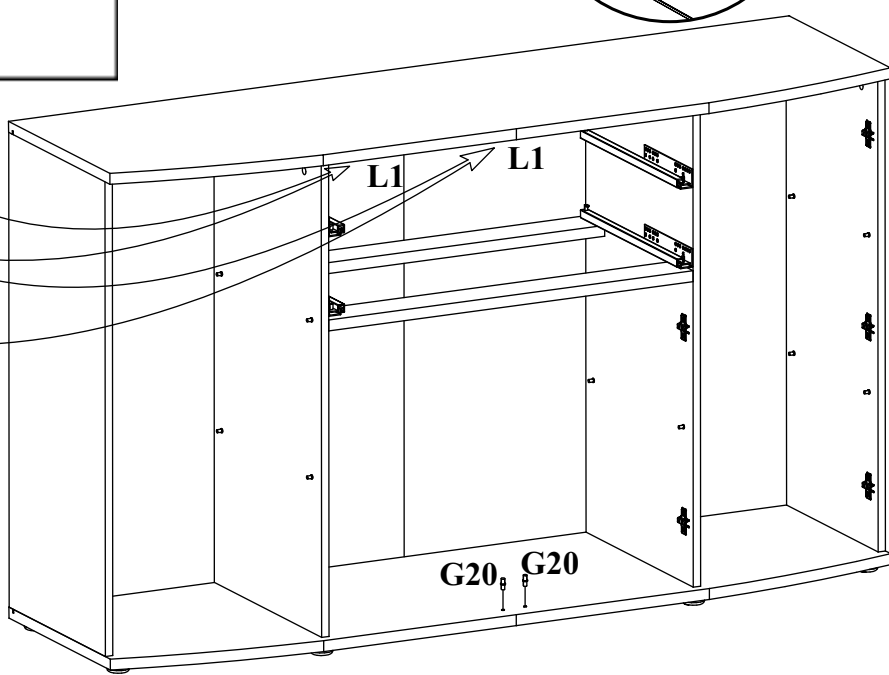
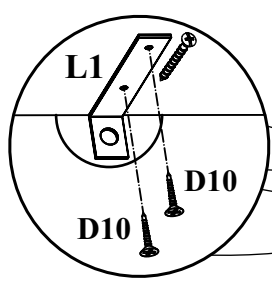
KR1	
x2	

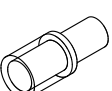

D10	
x4	USØ3,5x13

G20	
x2	

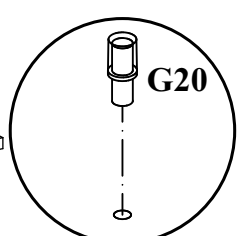

12

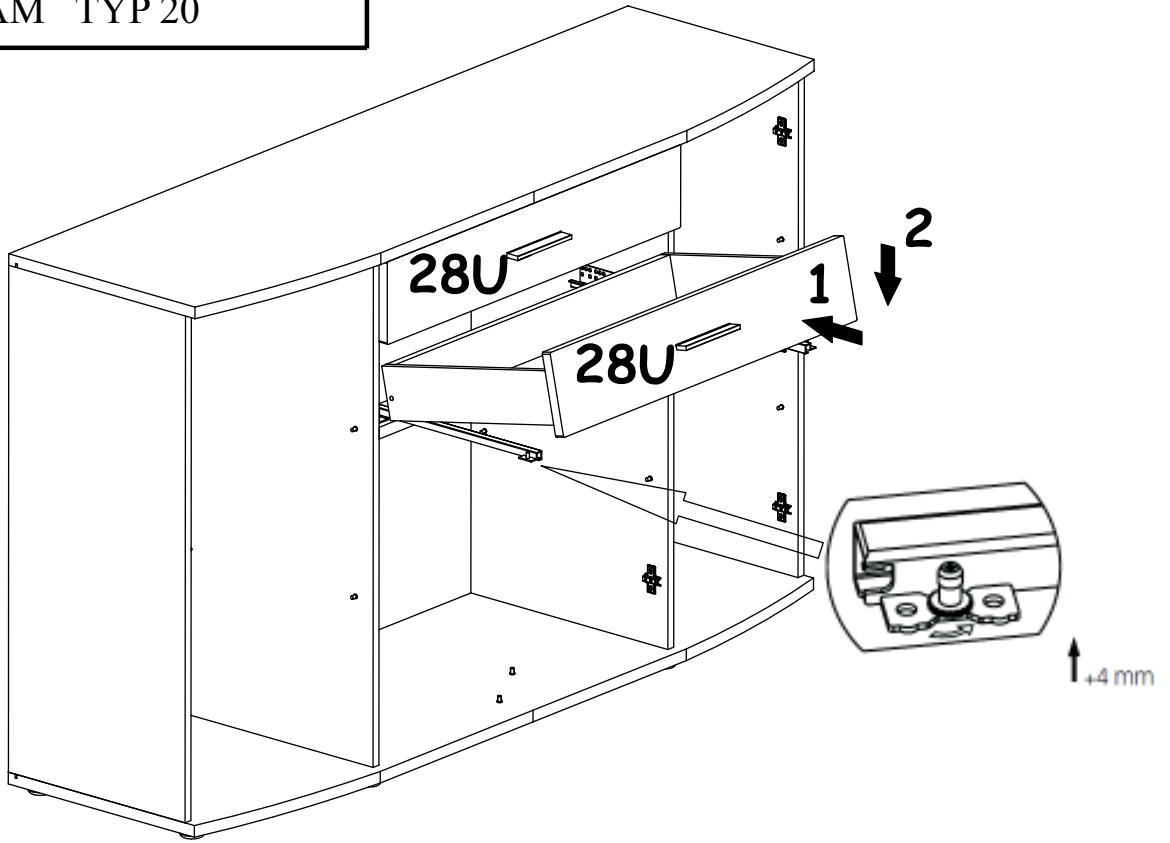

13

