

















## MONTAGEANLEITUNG

-  MONTAGEANLEITUNG
-  ASSEMBLY INSTRUCTION
-  DE INSTRUCTIE VAN DE ASSEMBLAGE
-  ISTRUZIONI DI MONTAGGIO
-  INSTRUCCIÓN ENSAMBLAJE
-  INSTRUCTION DE MONTAGE
-  NÁVOD K MONTÁŽI
-  MONTERINGSANVISNING

-  MONTAJ TALIMATI
-  ASENNUSOHJE
-  BRUGSANVISNING
-  BRUKSANVISNING
-  UPUTE ZA MONTAŽU
-  NAVODILA ZA MONTAŽO
-  SZERELÉSI ÚTMUTATÓ
-  INSTRUCTIUNI DE MONTAJ



Modell-Nr.

# 12150

ART.-NR. FRONT KORPUS

12152

Rot  
(ähnl. RAL 3002)

Silber

12157

Ultramarinblau  
(RAL 5002)

Silber

12156

Silber

Schwarz  
(RAL 9005)

Friedrich Küpper GmbH  
Friedrich-Küpper-Weg  
54570 Berlingen  
Deutschland

Telefon +49 (0) 65 91 - 95 42 0  
Telefax +49 (0) 65 91 - 95 42 17  
E-Mail [info@friedrich-kuepper.de](mailto:info@friedrich-kuepper.de)  
Internet [www.friedrich-kuepper.de](http://www.friedrich-kuepper.de)

## EINZELTEILE / PIECES

1× **A**

772 mm × 475 mm

Art.-Nr. E0154 (Silber/silver)  
Art.-Nr. E0155 (Schwarz/black)



1× **C**

1570 mm × 473 mm

Art.-Nr. E0179 (Silber/silver)  
Art.-Nr. E0180 (Schwarz/black)



1× **B**

772 mm × 475 mm

Art.-Nr. E0165 (Silber/silver)  
Art.-Nr. E0166 (Schwarz/black)



1× **D**

1570 mm × 473 mm

Art.-Nr. E0191 (Silber/silver)  
Art.-Nr. E0192 (Schwarz/black)



2× **F**

645 mm × 450 mm

Art.-Nr. E0211 (Silber/silver)  
Art.-Nr. E0212 (Schwarz/black)



1× **E**

1500 mm × 480 mm

Art.-Nr. E0200 (Silber/silver)

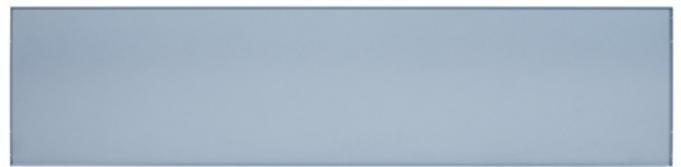

3× **K**

403 mm × 468 mm

Art.-Nr. E0230 (Silber/silver)  
Art.-Nr. E0227 (Rot/red)  
Art.-Nr. E0229 (Blau/blue)



1× **Y**

1700 mm × 600 mm

Art.-Nr. E0257



3× **L**

400 mm × 25 mm

Art.-Nr. E0233 (Silber/silver)  
Art.-Nr. E0234 (Schwarz/black)



3× **J**

450 mm × 120 mm

Art.-Nr. E0224 (Silber/silver)



3× **X**

450 mm × 20 mm

Art.-Nr. E0252 (Schwarz/black)



3× **H**

450 mm × 445 mm

Art.-Nr. E0215 (Silber/silver)



3× **I**

470 mm × 130 mm

Art.-Nr. E0221 (Silber/silver)  
Art.-Nr. E0218 (Rot/red)  
Art.-Nr. E0220 (Blau/blue)



## BEUTELINHALT / BAG CONTENT

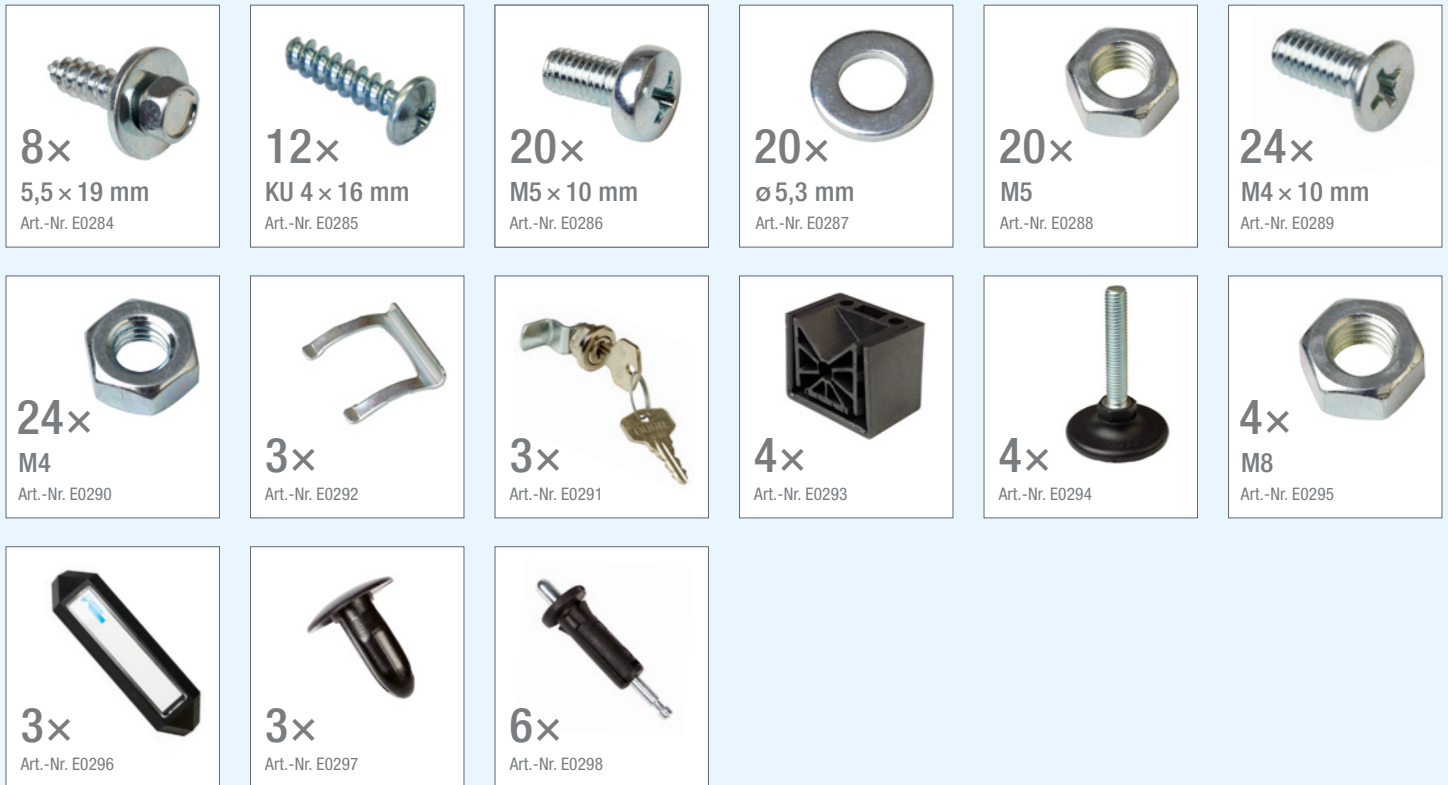

## BENÖTIGTES WERKZEUG / NEEDED TOOLS

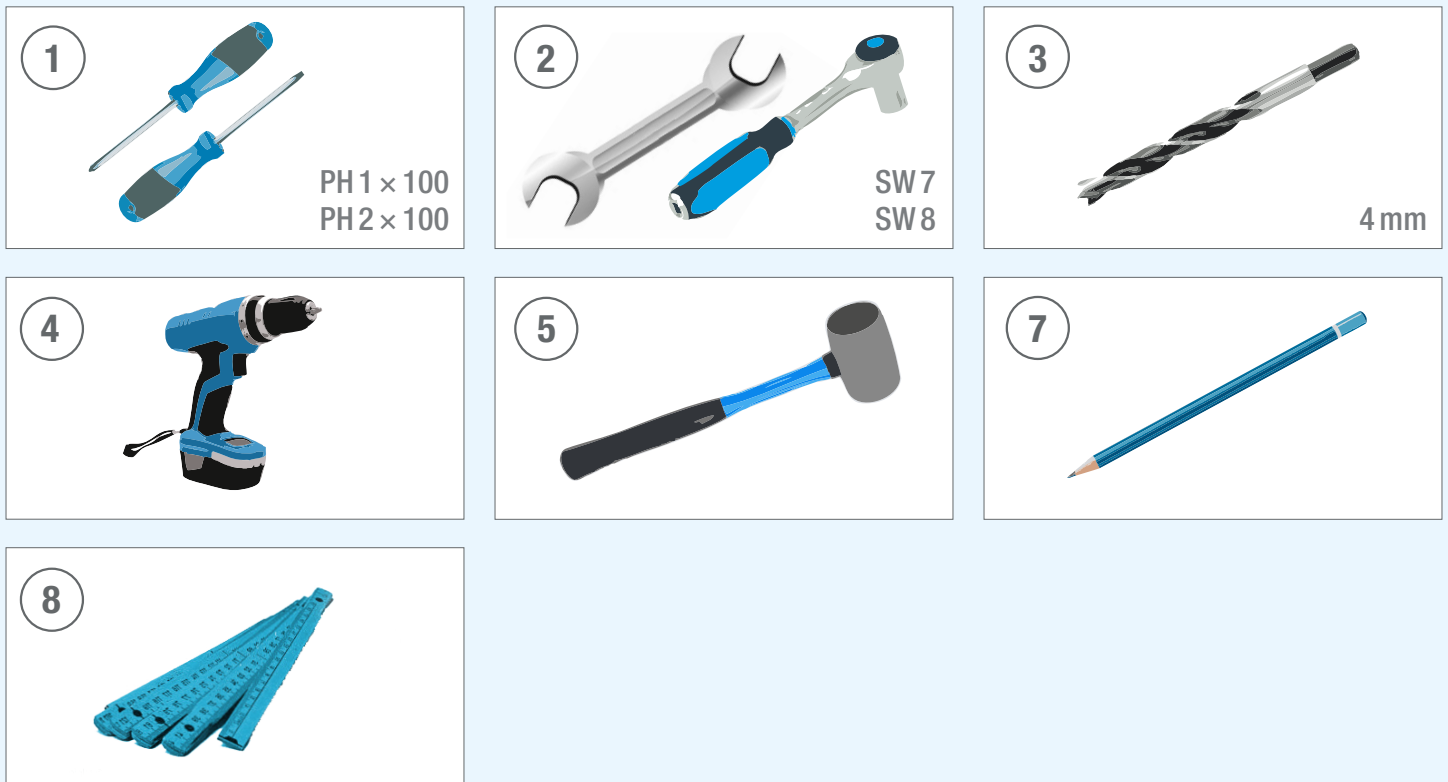

1. WICHTIG / IMPORTANT



2.

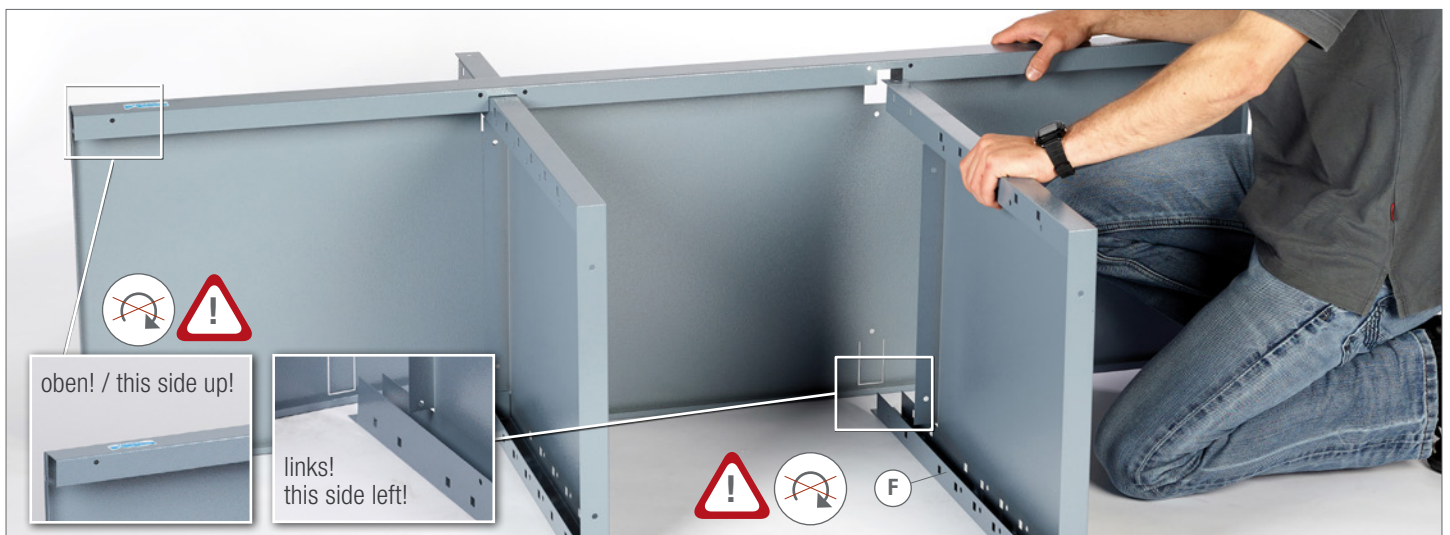

3.  4 × M5  4 × M5 × 10  4 × 5,3 MM

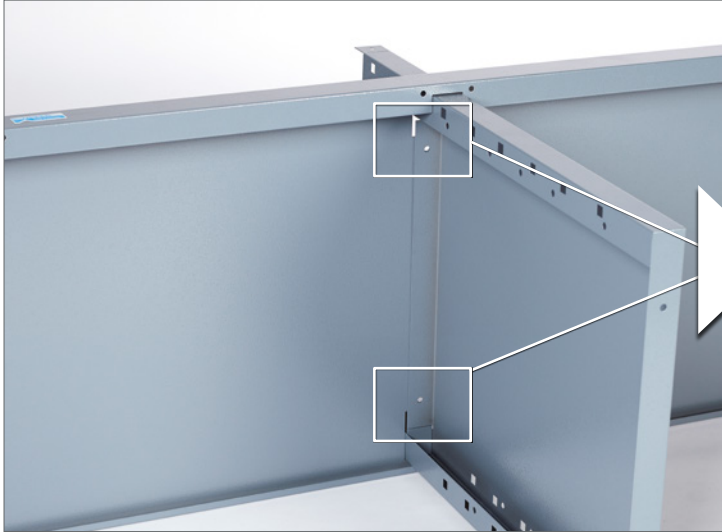

4.



5.  4 × M5  4 × M5 × 10  4 × 5,3 MM  ② SW 8  ① PH 2 × 100



6.



7.

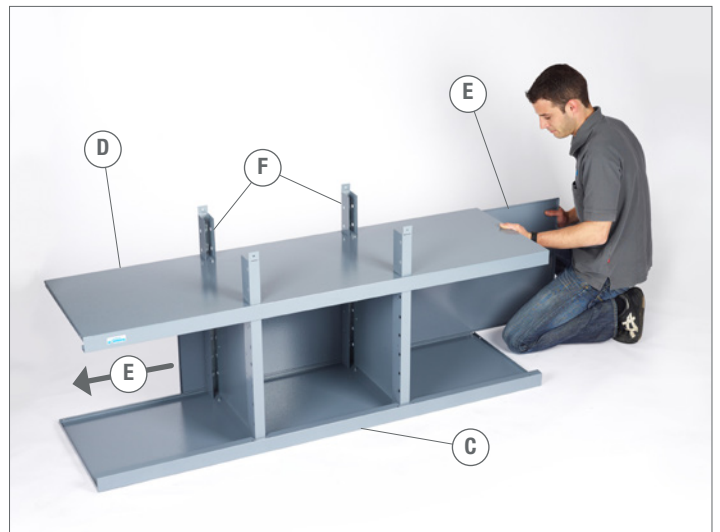

ZU SCHRITT 3. / IN ADDITION TO STEP 3.

②  SW 8    ①  PH2×100

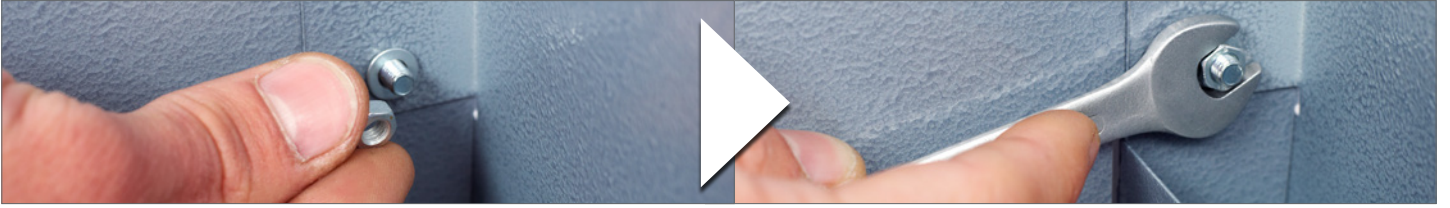

8. WICHTIG / IMPORTANT



9.  6×M5     6×M5×10     6×5,3MM    ②  SW 8    ①  PH2×100

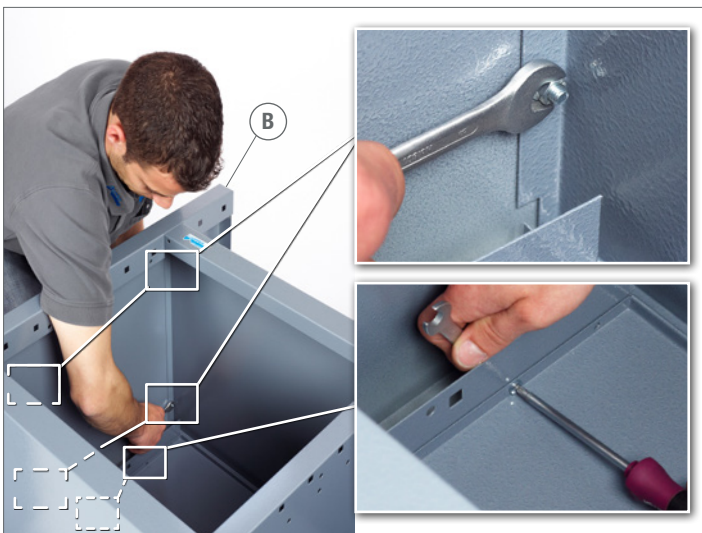

10.  6×M5     6×M5×10     6×5,3MM    ②  SW 8    ①  PH2×100



11. 4x M8 4x 4x 4x

5



12. 6x KU 4 x 16 3x

1 PH 2 x 100

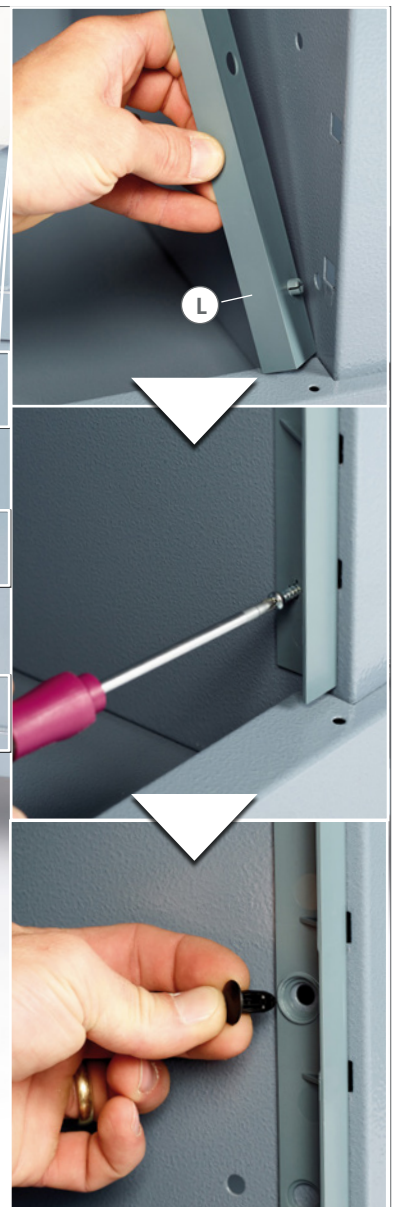

13.



14.

⑧ ⑦

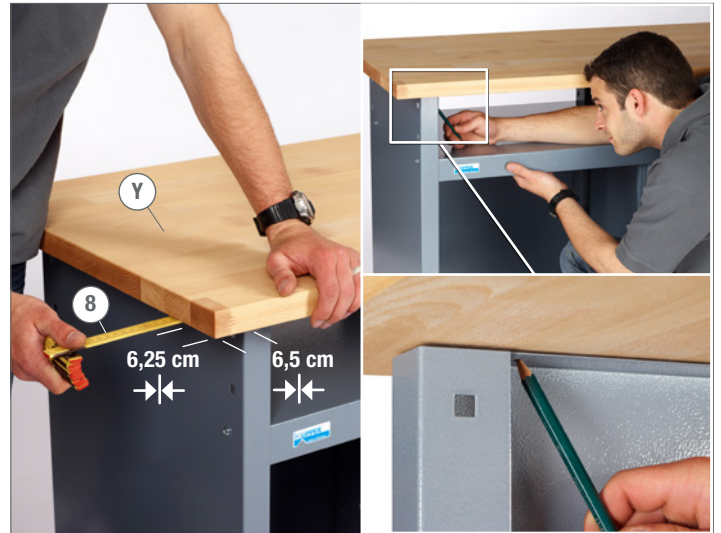

15.

④ ③



16.

8 × 5,5 × 19

② SW 8



17. 6 ×





18.



19.



20.

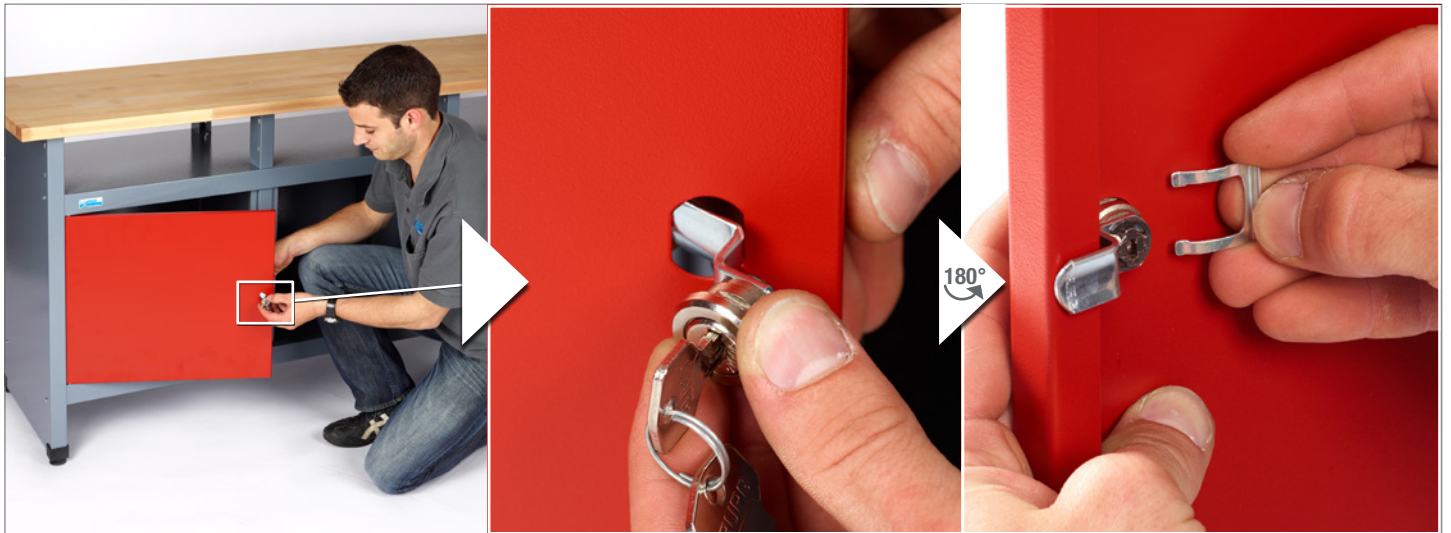

21.



22.



23.  6xM4  6xM4x10

 ② SW7  ① PH1x100

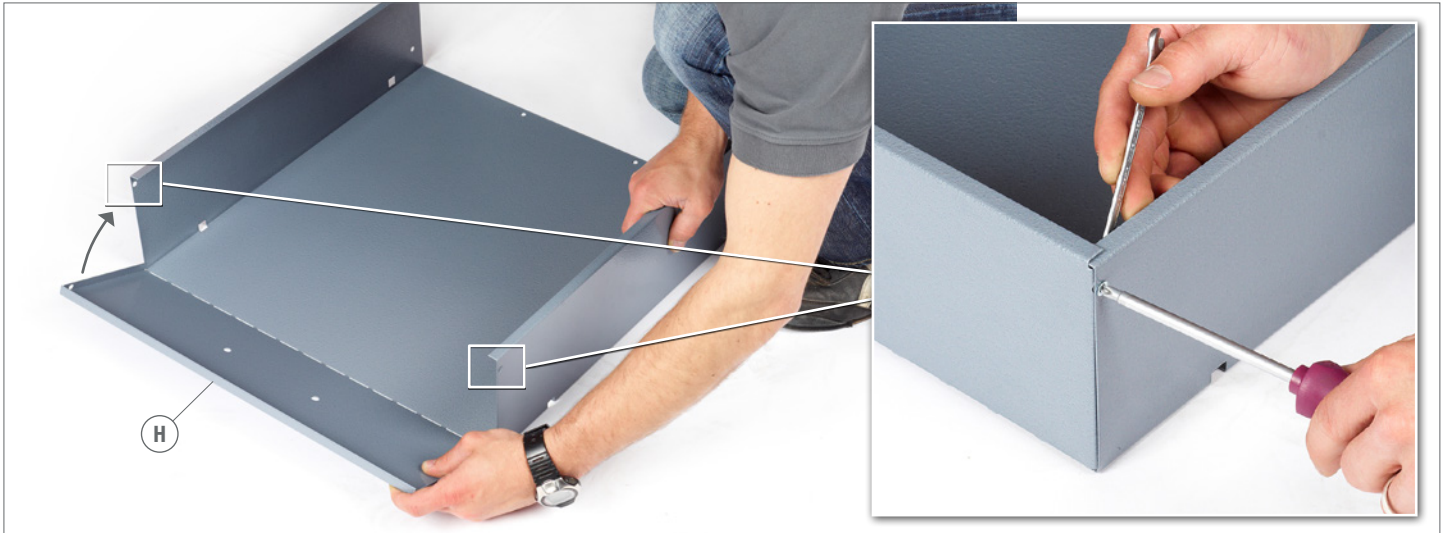

24.  18xM4  18xM4x10

 ② SW7  ① PH1x100

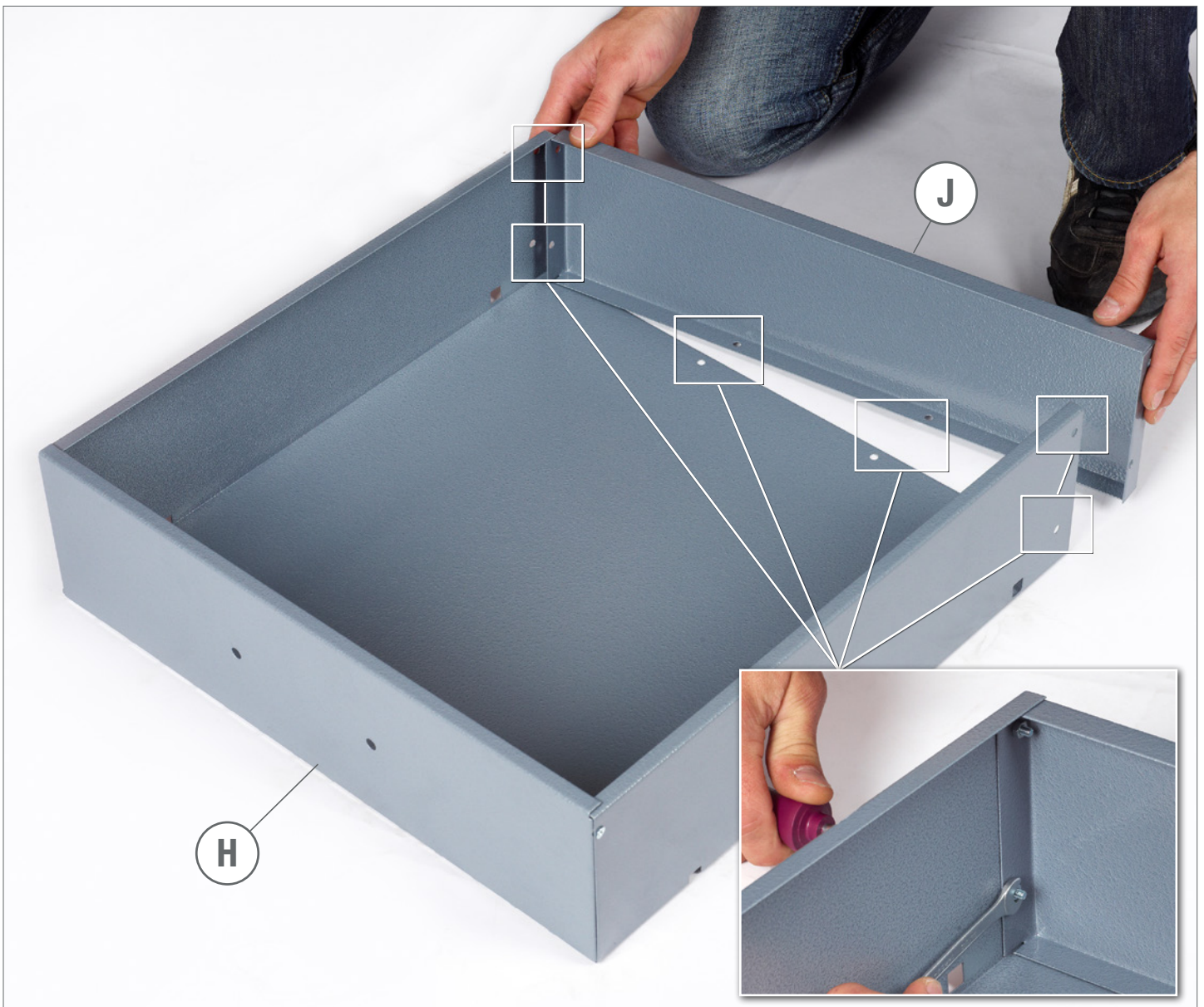

25.  1 x DL

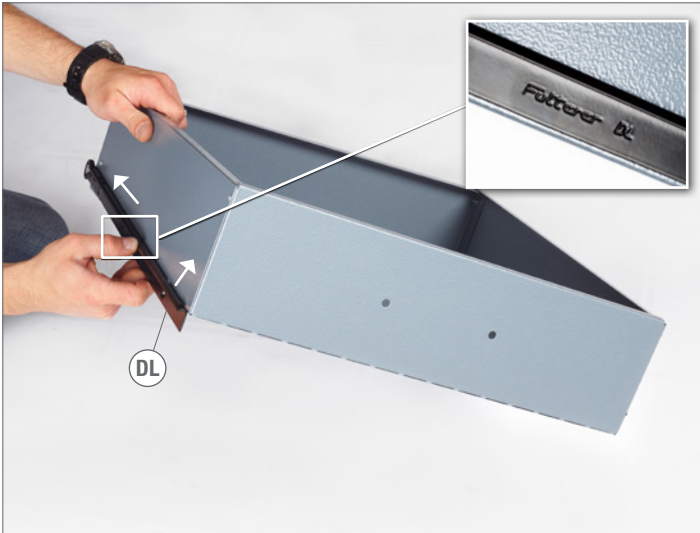

26.  1 x DR

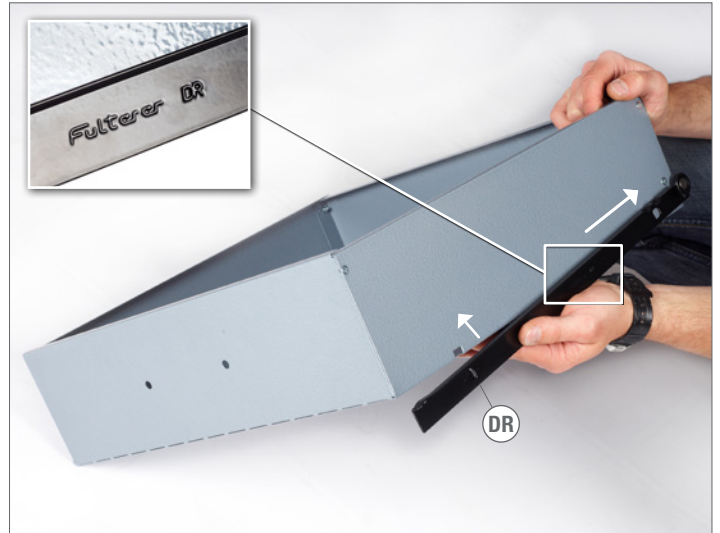

27.



28.  6 x KU 4 x 16    3 x     ①  PH2 x 100



29.



30.

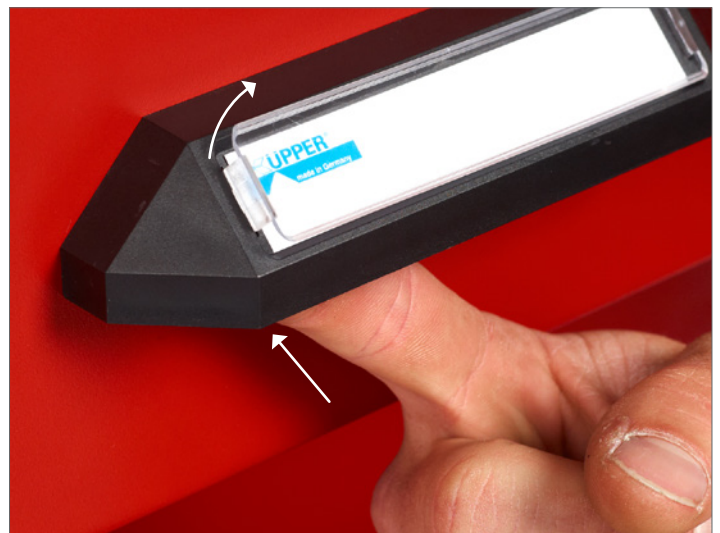

### WICHTIG / IMPORTANT

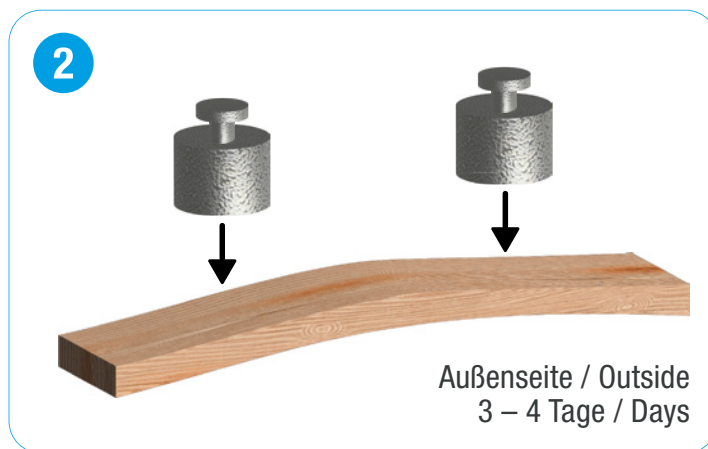

#### DE PFLEGEHINWEIS HOLZPLATTE

Massivholz ist gewachsene Natur. Weil es „arbeitet“, kann es sich bei Temperaturschwankungen und veränderter Luftfeuchtigkeit verziehen und muss daher besonders behandelt werden. Wir empfehlen die Oberfläche alle 6 Monate mit Holzöl nachzubehandeln und zu pflegen (auch handelsübliches Pflanzenöl möglich).

**Besondere Anmerkung!** Witterungseinflüsse während des Transportes können eine Wölbung des Holzes verursachen. Die Platte lässt sich in einem solchen Fall ganz einfach begradigen, indem Sie diese eben auf den Boden legen, ggf. beschweren und die nach Innen gewölbte Seite so lange ölen bis kein Öl mehr in die Platte einzieht.

#### EN CARE REFERENCE WOODENBOARD

Massive wood is a grown nature. Because it „works“, it can warp because of temperature variations and changed humidity and so the wood has to be especially attended. We suggest to warp the surface all 6 months with wood oil (customary vegetable oil also possible).

**Special Tip!** Because of influence of weather during the transport, the wood can arch. In such a case the board can be quite simply straightened by laying the board on the ground, if necessary weighting and then oiling the board inside.

#### FR INDICATION DE SOIN PLAQUE DU BOIS

Le bois massif est un produit naturel. A cause des variations de température et de l'humidité, le bois peut se déformer. A cause de cela il faut un traitement spécial. Nous recommandons de traiter la surface avec de l'huile de bois tous les 6 mois. (L'huile végétale commerciale est également possible).

**Avis spécial!** Les influences du temps durant le transport peuvent causer une voûture du bois. Dans ce cas vous pouvez corriger la plaque toute simplement en la mettant au sol, et éventuellement de la charger. Ensuite vous huilez la coté bombée vers l'intérieur jusqu'à ce que l'huile ne diminue plus.

#### CZ POKYNY PRO OŠETŘOVÁNÍ DŘEVĚNÝCH DESEK

Massivní dřevo je přírodní materiál. Jelikož „pracuje“, může se při působení teplotních výkyvů a změnách vlhkosti vzduchu zkroutit, a proto se musí dobře ošetřovat. Každých 6 měsíců doporučujeme nátěr běžně dostupným rostlinným olejem.

**Zvláštní upozornění!** Vlivy povětrnostních podmínek během dopravy mohou být příčinou prohnutí dřeva. Deska se v takových případech nechá velmi snadno vyrovnat. Položte ji na zem, event zatížíte a stranu, která je vyduťatá dovnitř natíráte olejem tak dlouho, dokud se olej nepřestane vsakovat.

#### SK POKYNY PRE OŠETROVANIE DREVENÝCH DOSIEK

Masívne drevo je prírodný materiál. Vzhľadom na to, že „pracuje“, môže sa pri pôsobení teplotných výkyvov a zmenách vlhkosti vzduchu skrútiť, a preto sa musí dobre ošetrovať. Každých 6 mesiacov doporučujeme nátěr bežne dostupným rastlinným olejom.

**Zvláštnie upozornenie!** Vplyvy poveternostných podmienok behom dopravy môžu byť príčinou prehnutia dreva. Doska sa v takom prípade nechá veľmi jednoducho vyrovnáť. Položte ju na zem, event zaťažte a stranu, ktorá je vyduťatá dovnútra natierate olejom tak dlho, pokiaľ sa olej neprestane vsakovať.

#### SI NAVODILA ZA NEGO LESENE PLOŠČE

Massivni les je pridelan v naravi. Ker „deluje“, se lahko deformira zaradi temperaturnih nihanj in sprememb vlažnosti, zato ga je treba posebej obdelati. Priporočamo, da površino vsakih 6 mesecev obdelate in vzdržujete z lesnim oljem (lahko tudi s komercialnim rastlinskim oljem).

**Posebna opomba!** Vremenski vplivi med prevozom lahko povzročijo deformacijo lesa. V takem primeru lahko desko enostavno poravnate tako, da jo položite ravno na tla, jo po potrebi obtežite in ukrivljeno stran naoljite, dokler v desko ne prodre več olja.

#### ES INDICACIÓN CUIDADO PLACA DE MADERA

Madera natural. Se puede deformar con cambios de temperatura o humedad. Es por eso que hay que cuidarlo de una manera especial. Recomendamos tratar y cuidar la superficie cada 6 meses con aceite vegetal.

**¡Aviso especial!** Influencias atmosféricas (durante el transporte) pueden causar arqueamientos en la madera. En este caso se puede rectificar la placa de una maneja facil. Hay que apoyar la placa en el suelo, si fuera necesario poner peso encima y aplicar el aceite vegetal en el lado interior (imagen) hasta que no absorba más aceite.

#### UNSER TIPP FÜR PROFIS / OUR TIP FOR PROFESSIONALS

Für die Behandlung empfehlen wir das Küpper Arbeitsplatten-Öl / We recommend for the handling the Küpper wooden oil.

Art. Nr. / Item Code: 11250



FR  
Donnez ou recyclez vos meubles.



Association



Magasin



Déchèterie

<https://quefairedemesdechets.fr>